

marantz[®]

AV Surround Receiver

SR7007

Owner's Manual

SAFETY PRECAUTIONS



CAUTION
RISK OF ELECTRIC SHOCK
DO NOT OPEN



CAUTION:
TO REDUCE THE RISK OF ELECTRIC SHOCK, DO NOT REMOVE COVER (OR BACK). NO USER-SERVICEABLE PARTS INSIDE. REFER SERVICING TO QUALIFIED SERVICE PERSONNEL.

The lightning flash with arrowhead symbol, within an equilateral triangle, is intended to alert the user to the presence of uninsulated "dangerous voltage" within the product's enclosure that may be of sufficient magnitude to constitute a risk of electric shock to persons.

The exclamation point within an equilateral triangle is intended to alert the user to the presence of important operating and maintenance (servicing) instructions in the literature accompanying the appliance.

WARNING:
TO REDUCE THE RISK OF FIRE OR ELECTRIC SHOCK, DO NOT EXPOSE THIS APPLIANCE TO RAIN OR MOISTURE.



Hot surface mark

CAUTION:
HOT SURFACE. DO NOT TOUCH.

The top surface over the internal heat sink may become hot when operating this product continuously. Do not touch hot areas, especially around the "Hot surface mark" and the top panel.

IMPORTANT SAFETY INSTRUCTIONS

1. Read these instructions.
2. Keep these instructions.
3. Heed all warnings.
4. Follow all instructions.
5. Do not use this apparatus near water.
6. Clean only with dry cloth.
7. Do not block any ventilation openings. Install in accordance with the manufacturer's instructions.
8. Do not install near any heat sources such as radiators, heat registers, stoves, or other apparatus (including amplifiers) that produce heat.
9. Do not defeat the safety purpose of the polarized or grounding-type plug. A polarized plug has two blades with one wider than the other. A grounding type plug has two blades and a third grounding prong. The wide blade or the third prong are provided for your safety. If the provided plug does not fit into your outlet, consult an electrician for replacement of the obsolete outlet.
10. Protect the power cord from being walked on or pinched particularly at plugs, convenience receptacles, and the point where they exit from the apparatus.
11. Only use attachments/accessories specified by the manufacturer.
12. Use only with the cart, stand, tripod, bracket, or table specified by the manufacturer, or sold with the apparatus. When a cart is used, use caution when moving the cart/apparatus combination to avoid injury from tip-over.
13. Unplug this apparatus during lightning storms or when unused for long periods of time.
14. Refer all servicing to qualified service personnel. Servicing is required when the apparatus has been damaged in any way, such as power-supply cord or plug is damaged, liquid has been spilled or objects have fallen into the apparatus, the apparatus has been exposed to rain or moisture, does not operate normally, or has been dropped.
15. Batteries shall not be exposed to excessive heat such as sunshine, fire or the like.



CAUTION:

To completely disconnect this product from the mains, disconnect the plug from the wall socket outlet. The mains plug is used to completely interrupt the power supply to the unit and must be within easy access by the user.

FCC INFORMATION (For US customers)

1. COMPLIANCE INFORMATION

Product Name: AV Surround Receiver

Model Number: SR7007

This product complies with Part 15 of the FCC Rules. Operation is subject to the following two conditions: (1) this product may not cause harmful interference, and (2) this product must accept any interference received, including interference that may cause undesired operation.

Marantz America, LLC.

(a D&M Holdings Company)

100 Corporate Drive,

Mahwah, NJ, 07430, U.S.A.

Tel. 201-762-6500

2. IMPORTANT NOTICE: DO NOT MODIFY THIS PRODUCT

This product, when installed as indicated in the instructions contained in this manual, meets FCC requirements. Modification not expressly approved by marantz may void your authority, granted by the FCC, to use the product.

3. IMPORTANT

When connecting this product to network hub or router, use only a shielded STP or ScTP LAN cable which is available at retailer.

Follow all installation instructions. Failure to follow instructions could void your authority, granted by the FCC, to use the product.

4. NOTE

This product has been tested and found to comply with the limits for a Class B digital device, pursuant to Part 15 of the FCC Rules. These limits are designed to provide reasonable protection against harmful interference in a residential installation.

This product generates, uses and can radiate radio frequency energy and, if not installed and used in accordance with the instructions, may cause harmful interference to radio communications. However, there is no guarantee that interference will not occur in a particular installation. If this product does cause harmful interference to radio or television reception, which can be determined by turning the product OFF and ON, the user is encouraged to try to correct the interference by one or more of the following measures:

- Reorient or relocate the receiving antenna.
- Increase the separation between the equipment and receiver.
- Connect the product into an outlet on a circuit different from that to which the receiver is connected.
- Consult the local retailer authorized to distribute this type of product or an experienced radio/TV technician for help.

For Canadian customers:

This Class B digital apparatus complies with Canadian ICES-003.

☐ NOTES ON USE

WARNINGS

- Avoid high temperatures.
Allow for sufficient heat dispersion when installed in a rack.
- Handle the power cord carefully.
Hold the plug when unplugging the cord.
- Keep the unit free from moisture, water, and dust.
- Unplug the power cord when not using the unit for long periods of time.
- Do not obstruct the ventilation holes.
- Do not let foreign objects into the unit.
- Do not let insecticides, benzene, and thinner come in contact with the unit.
- Never disassemble or modify the unit in any way.
- Ventilation should not be impeded by covering the ventilation openings with items, such as newspapers, tablecloths or curtains.
- Naked flame sources such as lighted candles should not be placed on the unit.
- Observe and follow local regulations regarding battery disposal.
- Do not expose the unit to dripping or splashing fluids.
- Do not place objects filled with liquids, such as vases, on the unit.
- Do not handle the mains cord with wet hands.
- When the switch is in the OFF (STANDBY) position, the equipment is not completely switched off from MAINS.
- The equipment shall be installed near the power supply so that the power supply is easily accessible.
- Do not keep the battery in a place exposed to direct sunlight or in places with extremely high temperatures, such as near a heater.

☐ CAUTIONS ON INSTALLATION

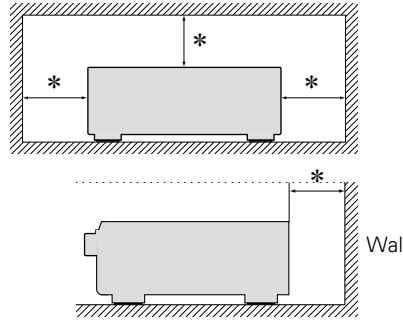

- * **For proper heat dispersal, do not install this unit in a confined space, such as a bookcase or similar enclosure.**
 - More than 12 in. (0.3 m) is recommended.
 - Do not place any other equipment on this unit.

Getting started

Thank you for purchasing this marantz product. To ensure proper operation, please read this owner's manual carefully before using the product. After reading them, be sure to keep them for future reference.

Contents

Getting started	1
Accessories.....	2
Features.....	2
Cautions on handling.....	3

Basic version.....[4](#)

Connections	5
Important information.....	5
Connecting an HDMI-compatible device.....	8
Connecting an HDMI-incompatible device.....	13
Connecting a device with a multi-channel output connector.....	25
Connecting an external power amplifier.....	26
Connecting to a home network (LAN).....	27
Connecting the power cord.....	28
Setup	29
Set up speakers (Audyssey® Setup).....	29
Making the network settings (Network).....	35
Playback (Basic operation)	36
Important information.....	36
Playing a Blu-ray Disc player/DVD player.....	37
Playing Super Audio CD.....	37
Playing a CD player.....	38
Playing an iPod.....	39
Playing a USB memory device.....	42
Listening to HD Radio stations.....	45
Network contents	54
Listening to internet radio.....	54
Playing back files stored on a PC and NAS.....	57
Using online services.....	61
Convenient functions.....	69
AirPlay function.....	73
Selecting a listening mode (Sound Mode)	75
Selecting a listening mode.....	75

Advanced version.....[81](#)

Installation/connection/setup of speakers (Advanced)	82
Speaker installation.....	82
Speaker connection.....	84
Set up speakers.....	91
Connections (Advanced connection)	94
Connecting the REMOTE CONTROL connectors.....	94
Connecting an external control device.....	95
Playback (Advanced operation)	96
HDMI control function.....	96
Sleep timer function.....	98
Web control function.....	99
Dual backup memory function.....	101
Panel lock function.....	101
Remote lock function.....	102
Switches light illumination on/off.....	103
Various memory functions.....	103
Playback in ZONE2/ZONE3 (Separate room)	104
Audio output.....	104
Video output.....	105
Playback.....	106
Sleep timer function.....	106
How to make detailed settings	107
Menu map.....	107
Examples of menu screen displays.....	109
Examples of menu and front display.....	110
Inputting characters.....	111
Audio.....	112
Video.....	119
Inputs.....	125
Speakers.....	130
Network.....	135
General.....	139
Operating external devices with the remote control	145
Registering preset codes.....	145
Operating external devices.....	148
Operating learn function.....	151
Setting the back light.....	153
Specifying the zone used with the main remote control unit.....	153

Informations.....[154](#)

Part names and functions	155
Front panel.....	155
Display.....	157
Rear panel.....	159
Remote control unit.....	160
Other information	162
Trademark information.....	162
Surround.....	163
Relationship between video signals and monitor output.....	169
Explanation of terms.....	171
Troubleshooting	174
Resetting the microprocessor.....	179
Specifications	180

Accessories

Check that the following parts are supplied with the product.

① Getting Started	1
② CD-ROM (Owner's manual)	1
③ Safety Instructions	1
④ Warranty card (for USA)	1
⑤ Warranty card (for CANADA)	1
⑥ Power cord	1
⑦ Remote control unit (RC016SR)	1
⑧ R03/AAA batteries	2
⑨ Setup microphone (ACM1HB)	1
⑩ AM loop antenna	1
⑪ FM indoor antenna	1

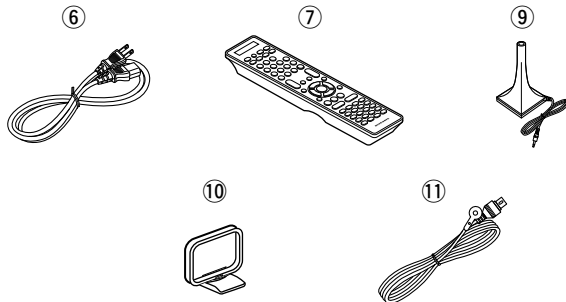

Features

Digital video processor up-scales analog video signals (SD resolution) to 4K

This unit is equipped with the 4K video upscaling function, which allows for outputting analogue or SD (standard video quality) video to HDMI at 4K (3840 × 2160 pixels). This enables the unit and a TV connected with a single HDMI cable and any video source to be reproduced precisely with HD level of quality.

Equipped with “Hybrid PLL Jitter Reducer” capable of reducing jitter and phase noise that negatively affect sound quality

“Hybrid PLL Jitter Reducer” provided with this unit improves the sound localization, reproducing a natural sound field.

Equipped with a Multi-Zone Function 3 zone output (incl.HDMI output for ZONE2)

This unit is equipped with a multi-zone function, so you can enjoy separate sound sources in three rooms including MAIN ZONE. Furthermore, this unit is equipped with an HDMI ZONE2 OUT connector, so you can play back in ZONE2 a video that is different from the one played back in MAIN ZONE.

With a discrete-circuit configuration, the power amplifier provides identical quality for all 7 channels (125 W x 7ch, 8 Ω)

The unit is equipped with a power amplifier that reproduces highfidelity sound in sound mode with equal quality and power for all channels, true to the original sound.

The power amplifier circuit adopts a discrete-circuit configuration that achieves high-quality surround sound reproduction.

Supports internet radio, music, and photograph streaming

Supports AirPlay® (page 73)

You can enjoy a wide variety of content, including listening to Internet radio, playing the audio files stored on your PC, and displaying on a TV the photographs stored on your PC.

This unit also supports AirPlay that lets you stream your music library from an iPhone, iPad, iPod touch or iTunes.

Compatible with “marantz Remote App” for performing basic operations of the unit with an iPad, iPhone*1 or Android smartphone

“marantz Remote App” is application software that allows you to perform basic operations with an iPad, iPhone, Android smartphone or Android tablet such as turning the unit ON/OFF, controlling the volume, and switching the source.

*1 Download “marantz Remote App” from iTunes® App Store. The unit needs to be connected to a LAN and the iPhone/iPod touch needs to be connected to the same network by Wi-Fi (wireless LAN).

“Setup Assistant”, providing easy-to-follow setup instructions

First select the language when prompted. Then simply follow the instructions displayed on the TV screen to set up the speakers, network, etc.

Easy to use, Graphical User Interface

This unit is equipped with an easy to see "Graphical User Interface" that uses menu displays and levels. The use of level displays increases operability of the this unit.

HDMI connectors enable connection to various digital AV devices (input: 7, output: 3)

The unit is equipped with 7 HDMI input connectors for connecting devices with HDMI connectors, such as a Blu-ray Disc player, game machine, HD digital camcorder, etc.

Supports HDMI (3D, ARC, Deep Color, "x.v.Color", Auto Lip Sync, 4K) and HDMI control function (page 8)

In addition to HDMI 3D and ARC (Audio Return Channel) functions, this unit supports the video pass-through function, which outputs video to TV without changing the video quality when video signals of 4K (3840 × 2160 pixels) are input, and the GUI overlay function, which overlays the menu screen (GUI) on the 4K video screen.

Simultaneous playback on two HDMI channels (except for ZONE2 HDMI output)

This unit is equipped with two HDMI MONITOR outputs. You can connect one output to a projector and the other output to a TV for simultaneous signal outputs.

Direct play for iPod® and iPhone® via USB (page 20)

Music data from an iPod can be played back if you connect the USB cable supplied with the iPod via the iPod/USB port of this unit, and also an iPod can be controlled with the remote control unit for this unit.

Audyssey DSX®

This unit is equipped with Audyssey DSX® processor. By connecting front height speakers to this unit and playing back through Audyssey DSX®, you can experience a more powerful playback expression in the height audio range. By connecting front wide speakers, you can experience a more powerful playback expression in the wide audio range.

M-XPort (marantz-eXtension Port) (page 24)

This unit is equipped with the M-XPort, a marantz original innovation that provides outstanding expandability. You can connect the Wireless Receiver RX101 (sold separately) to this port.

Cautions on handling**• Before turning the power on**

Check once again that all connections are correct and that there are no problems with the connection cables.

- Power is supplied to some of the circuitry even when the unit is set to the standby mode. When going on vacation or leaving home for long periods of time, be sure to unplug the power cord from the power outlet.

• About condensation

If there is a major difference in temperature between the inside of the unit and the surroundings, condensation (dew) may form on the operating parts inside the unit, causing the unit not to operate properly.

If this happens, let the unit sit for an hour or two with the power turned off and wait until there is little difference in temperature before using the unit.

• Cautions on using mobile phones

Using a mobile phone near this unit may result in noise. If that occurs, move the mobile phone away from this unit when it is in use.

• Moving the unit





Turn off the power and unplug the power cord from the power outlet. Next, disconnect the connection cables to other system units before moving the unit.

• About care

- Wipe the cabinet and control panel clean with a soft cloth.
- Follow the instructions when using a chemical cleaner.
- Benzene, paint thinner or other organic solvents as well as insecticide may cause material changes and discoloration if brought into contact with the unit, and should therefore not be used.

Basic version

Here, we explain the connections and basic operation methods for this unit.

- **Connections**  [page 5](#)
- **Setup**  [page 29](#)
- **Playback (Basic operation)**  [page 36](#)
- **Selecting a listening mode (Sound Mode)**  [page 75](#)

Connections

Important information

Make connections before using this unit.

To create a home theater that can play back higher quality video and audio by fully utilizing the capabilities of this unit and your video devices, connect this unit to each of your video devices with HDMI cables.

❑ HDMI-compatible device

If your video device does not support HDMI connections, use the following connection.

❑ HDMI-incompatible device

This unit can change the source that is assigned to the DIGITAL AUDIO IN and COMPONENT VIDEO IN connectors.







You can change the source for connectors listed in **Input connector setting** within pages that describe connections for devices.

For details on assigning a source to connectors, see “Changing the source assigned to connectors” (👉 [page 13](#)). For the setting method, see “Input Assign” (👉 [page 126](#)).













NOTE

- The menu screen is only displayed on TV connected to this unit via HDMI. If your TV is connected to this unit via other video output connectors, perform menu operations while seeing the display on this unit.
- Do not plug in the power cord until all connections have been completed. However, when the “Setup Assistant” is running, follow the instructions in the “Setup Assistant” (📖 [page 7](#)) screen for making connections. (During “Setup Assistant” operation, the input/output connectors do not conduct current.)
- When running the “Setup Assistant” (📖 [page 7](#)), turn off the power supply of connected devices.
- When making connections, also refer to the operating instructions of the other devices being connected.
- Be sure to connect the left and right channels properly (left with left, right with right).
- Do not bundle power cords together with connection cables. Doing so can result in noise.

❑ HDMI-compatible device

 TV	👉 page 9	 CBL/SAT	👉 page 11	 DVD	👉 page 11
 Blu-ray	👉 page 11	 GAME	👉 page 11	 AUX	👉 page 11
 MEDIA PLAYER	👉 page 11				

❑ HDMI-incompatible device

 TV	👉 page 14	 CBL/SAT	👉 page 15	 DVD	👉 page 17
 Blu-ray	👉 page 17	 AUX	👉 page 18	 MEDIA PLAYER	👉 page 19
 iPod/USB	👉 page 20	 CD	👉 page 21	 PHONO	👉 page 22
 TUNER	👉 page 23	 M-XPoRT	👉 page 24	 NETWORK	👉 page 27

❑ Others

 SPEAKER	👉 page 84	 AC IN	👉 page 28
--	---------------------------	--	---------------------------

Converting input video signals for output (Video conversion function)

This unit is equipped with three types of video input connectors (HDMI, Component video and video) and three types of video output connectors (HDMI, Component video and video).

This function automatically converts various formats of video signals input to this unit into the formats used to output the video signals from this unit to a monitor.

[Flow of video signals for MAIN ZONE]

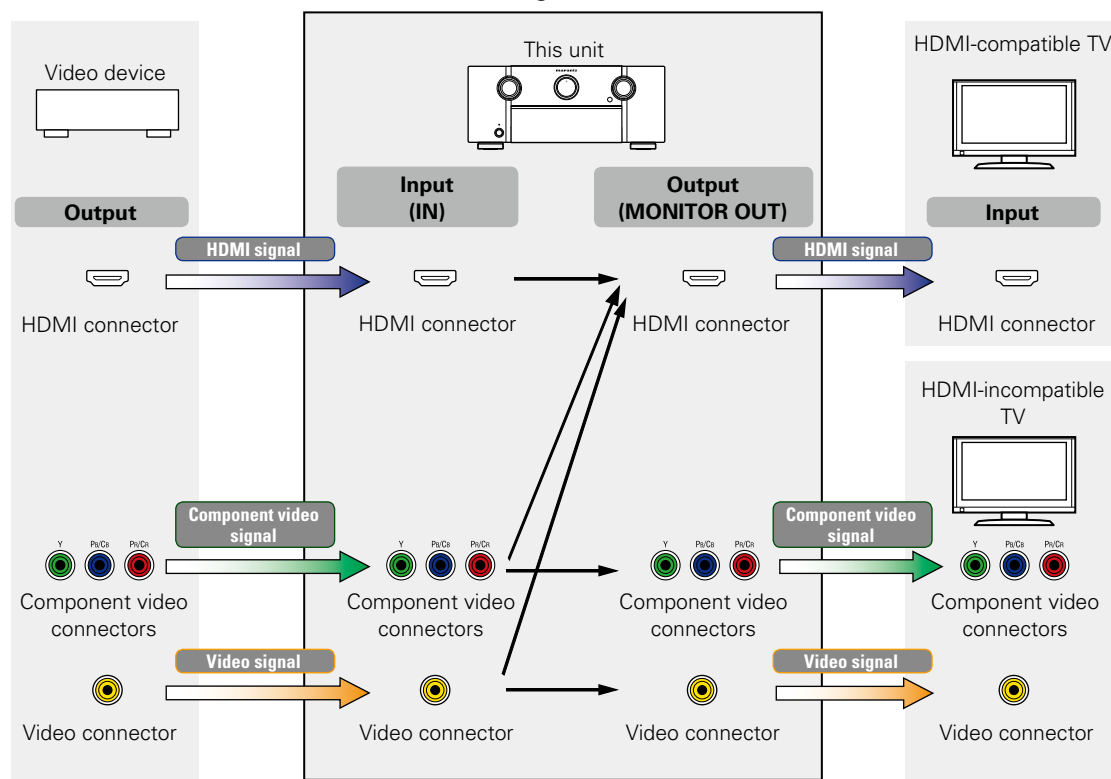

For example, if you connect this unit to an HDMI-compatible TV with a single HDMI cable, this unit automatically converts input signals other than HDMI video signals to HDMI signals to output from the HDMI connector to the TV. This unit outputs only one type of video signals, so video signals output from this unit to the TV remain unchanged even if you switch to a device that outputs another type of video signals for playback. Therefore, you do not need to switch the video input on the TV. Furthermore, this unit converts the input analog video signals such as video and component video signals to high resolution digital HDMI video signals for output, improving the quality of the video.

If your TV does not support HDMI connections, connect this unit to TV with analog video connectors. This unit can not convert HDMI input signals to analog video signals, so when inputting from an HDMI device, use component video or video input connectors.

Make Settings as Necessary

- If you do not want this unit to convert video signals automatically, use the following setting item to disable this function.
"Video Conversion" (page 122)
- If you want to change the resolution of video signals output to the TV, use the following setting item to do so.
"Resolution" (page 122)



- The video conversion function supports the NTSC, PAL, SECAM, NTSC 4.43, PAL-N, PAL-M and PAL-60 formats.
- Resolutions of HDMI-compatible TVs can be checked at "Video" – "Monitor" (page 142).

NOTE

- **The menu screen is only displayed on TV connected to this unit via HDMI. If your TV is connected to this unit via other video output connectors, perform menu operations while seeing the display on this unit.**
- HDMI signals are digital. HDMI signals cannot be converted into analog signals.
- When a non-standard video signal from a game machine or some other source is input, the video conversion function might not operate.
- The HDMI ZONE function is only compatible with the HDMI 1-6 IN connectors. It is not compatible with the HDMI 7 IN connector.

[Flow of video signals for ZONE2]

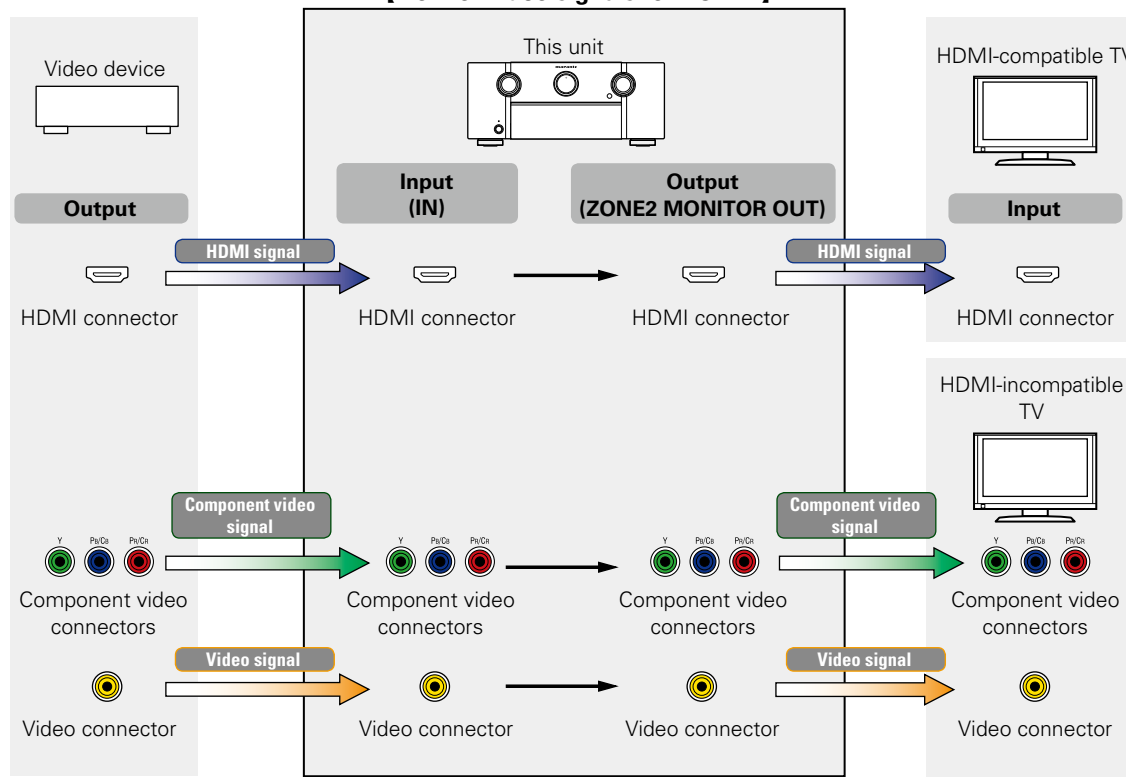

NOTE

- HDMI signals are digital. HDMI signals cannot be converted into analog signals.
- The HDMI ZONE function is only compatible with the HDMI 1-6 IN connectors. It is not compatible with the HDMI 7 IN connector.

Connecting an HDMI-compatible device

You can connect up to ten HDMI-compatible devices (7-inputs/3-outputs) to the unit.

When a TV is connected to the HDMI ZONE2 OUT connector, you can play back a video or audio from the device connected to the HDMI 1 – 6 IN connector in ZONE2 ([page 104](#)).

If the device connected to this unit is equipped with an HDMI connector, it is recommended to use HDMI connections. Connections with an HDMI cable offer the following benefits that can not be achieved with other connection methods.

- **High quality playback by transmitting audio and video via digital signals**

HDMI connections can transmit high definition video and high quality audio formats adopted by Blu-ray disc players (Dolby Digital Plus, Dolby TrueHD, dts-HD, dts-HD Master Audio).

HDMI connections also convey information required for playback between devices. The information is used for copyright protection and TV resolution recognition, the ARC function, the HDMI control function, etc.

- **Transmission of audio and video signals with a single HDMI cable**

Previous connections require multiple audio and video cables, but HDMI connections require only a single HDMI cable to transmit audio and video signals. This allows wires in a home theater system, which tend to be complicated, to be more organized.

- **Mutual control through the HDMI control function ([page 96](#))**

This unit and the HDMI device connected via HDMI can be linked to perform operations such as power control, volume control, and input source switching.

- **Other video and audio functions, such as 3D video playback, Content Type, the ARC function, are supported ([page 12](#)).**



- There is more than one version of HDMI standard. The supported functions and the performance vary according to the version. This unit complies with the HDMI standard, supporting the ARC and 3D playback functions. To enjoy these functions, the HDMI device connected to this unit also needs to use the same version of the standard. For the version of the HDMI standard on the device connected to this unit, see the device's manual.
- Some TVs do not support audio input via HDMI connections. For details, see your TV's manual.

❑ **Before connecting this unit to TV via HDMI connections** ([page 9](#))

❑ **Connecting this unit to a TV via HDMI connections** ([page 10](#))

❑ **Connecting this unit to video devices via HDMI connections** ([page 11](#))

❑ **HDMI function** ([page 12](#))

❑ **Settings related to HDMI connections** ([page 12](#))

Before connecting this unit to TV via HDMI connections

There are 2 methods to connect HDMI-compatible TV to this unit.
Use the connection method that suits your TV.

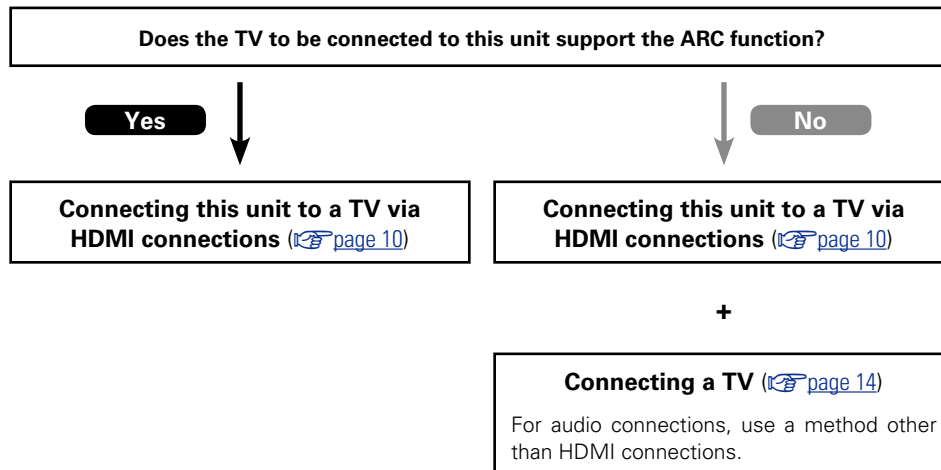

About ARC (Audio Return Channel) function

This function plays TV audio on this unit by sending the TV audio signal to this unit via HDMI cable. If a TV without the ARC function is connected via HDMI connections, video signals of the playback device connected to this unit are transmitted to the TV, but this unit can not play back the audio from the TV. If you want to enjoy surround audio for TV program, a separate audio cable connection is required.

In contrast, if a TV with the ARC function is connected via HDMI connections, no audio cable connection is required. Audio signals from the TV can be input to this unit through the HDMI cable between this unit and the TV. This function allows you to enjoy surround playback on this unit for the TV.



When the ARC function is used, connect a device with a “Standard HDMI cable with Ethernet” or “High Speed HDMI cable with Ethernet” for HDMI.

Refer to the owner’s manual for your TV for details about TV connection and settings.

NOTE

The HDMI ZONE2 OUT connector is not compatible with the ARC function.

[Connection to a TV with the ARC function]

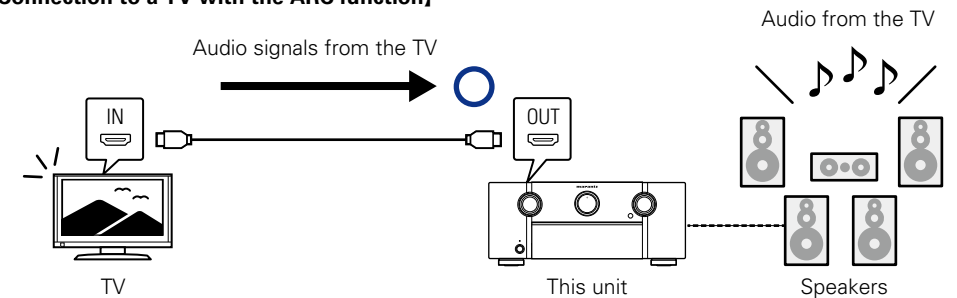

[Connection to a TV without the ARC function]

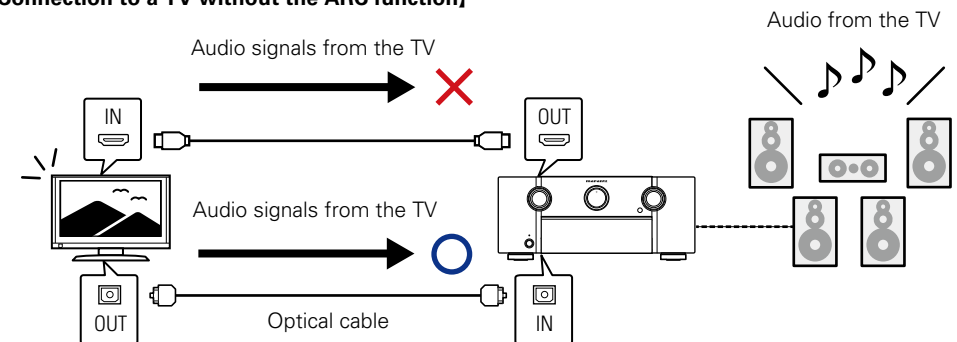

Connecting this unit to a TV via HDMI connections

When a TV is connected to the HDMI ZONE2 OUT connector, you can play back a video or audio from the device connected to the HDMI 1 – 6 IN connector in ZONE2 ([page 104](#)).

Cables used for connections

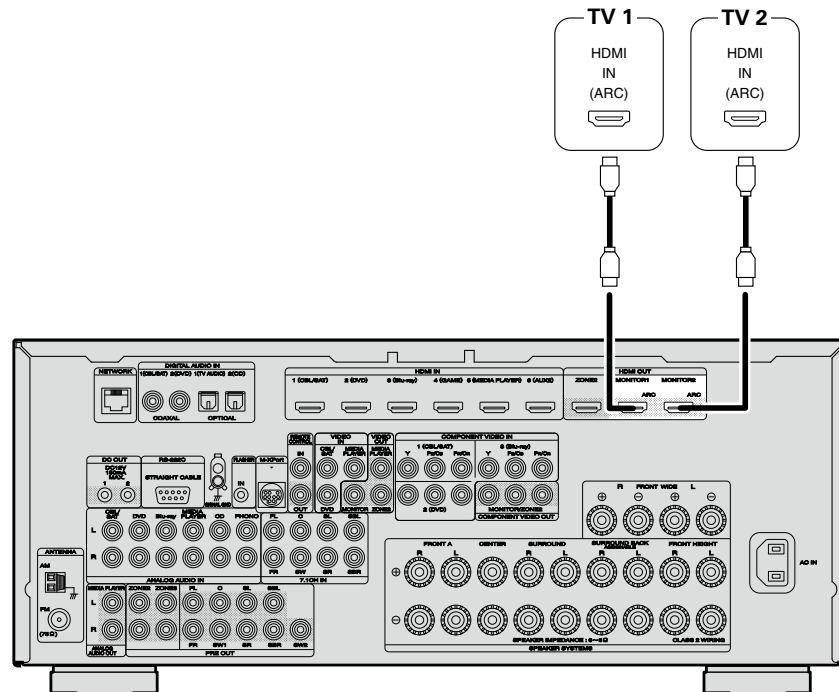
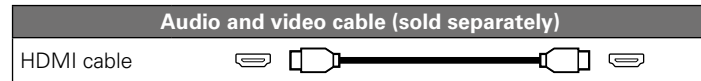

- Video signals are not output if the input video signals do not match the monitor's resolution. In this case, switch the Blu-ray Disc/DVD player's resolution to a resolution with which the monitor is compatible.
- When this unit and monitor are connected with an HDMI cable, if the monitor is not compatible with HDMI audio signal playback, only the video signals are output to the monitor. Make audio connections ([page 14](#) "Connecting a TV").

NOTE

- The audio signal from the HDMI output connector (sampling frequency, number of channels, etc.) may be limited by the HDMI audio specifications of the connected device regarding permissible inputs.
- **When connecting a TV that does not support the ARC function, an audio cable connection is required in addition to the HDMI cable. In this case, refer to "Connecting a TV" ([page 14](#)) for the connection method.**
For the ARC function, see "About ARC (Audio Return Channel) function" ([page 9](#)).

Connecting to a device equipped with a DVI-D connector

The DVI-D (Digital Visual Interface) method is also used for video transmission via digital signals. This is developed mainly for computers, and some AV devices such as projectors are equipped with this interface. To output HDMI video signals to a DVI-D video input compatible device, use an HDMI/DVI conversion cable, which converts HDMI video signals to DVI signals.

The DVI-D connector can transmit high quality digital signals, but the copy guard and other issues may hinder normal operations for some device combinations.

NOTE

- No sound is output when connected to a device equipped with a DVI-D connector. Make audio connections as described in "Connecting a TV" ([page 14](#)).
- Signals cannot be output to DVI-D devices that do not support HDCP.
- Depending on the combination of devices, the video signals may not be output.

Settings required when using a TV that supports the ARC function

When using a TV that supports the ARC function, make the following settings.

- Set "HDMI Control" ([page 121](#)) to "On".
- Set "Control Monitor" ([page 121](#)) to match the number of the HDMI MONITOR connector connected to the TV that supports the ARC function.

NOTE

If the TV that supports the ARC function is connected to both HDMI MONITOR 1 and HDMI MONITOR 2 connectors, you cannot use ARC function at the same time.

Connecting this unit to video devices via HDMI connections

Cables used for connections

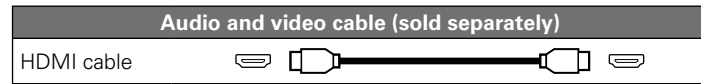

- This interface allows transfer of digital video signals and digital audio signals over a single HDMI cable.

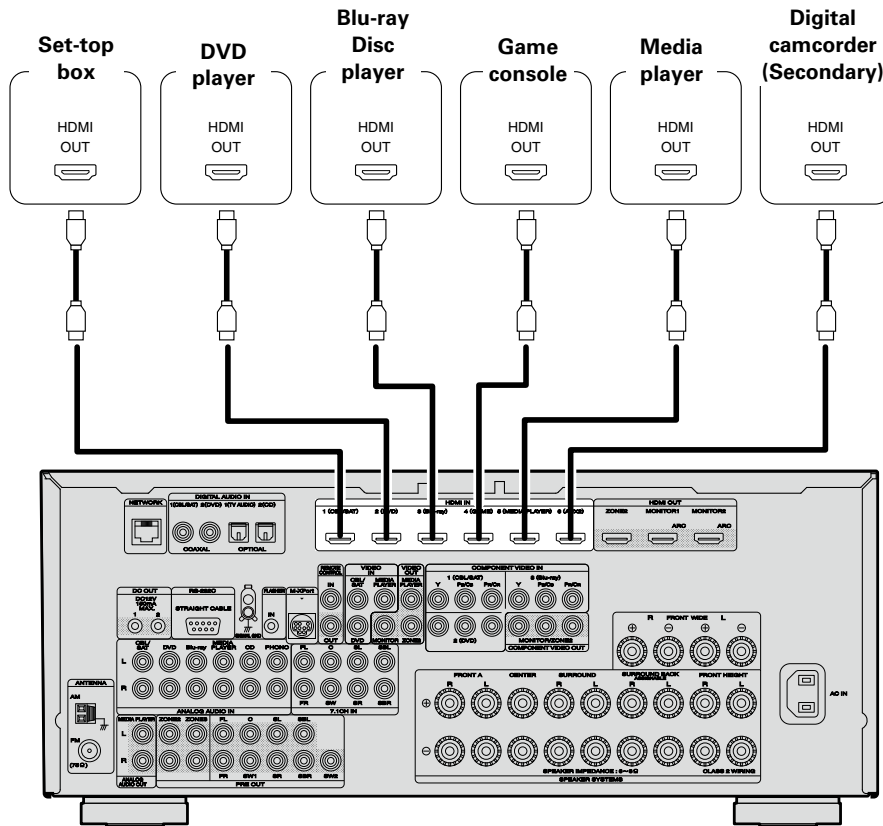

[Rear panel]

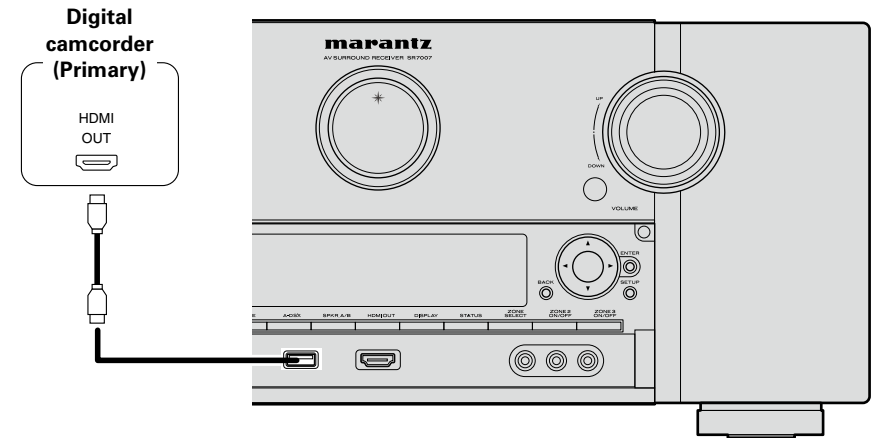

[Front panel]



- When this unit is connected to other devices with HDMI cables, connect this unit and TV also with an HDMI cable.
- When connecting a device that supports Deep Color or 4K, please use a “High Speed HDMI cable” or “High Speed HDMI cable with Ethernet”.
- Video signals are not output if the input video signals do not match the monitor’s resolution. In this case, switch the Blu-ray Disc/DVD player’s resolution to a resolution with which the monitor is compatible.

HDMI function

This unit supports the following HDMI functions:

□ About 3D function

This unit supports input and output of 3D (3 dimensional) video signals of HDMI.

To play back 3D video, you need a TV and player that provide support for the HDMI 3D function and a pair of 3D glasses.

NOTE

- When playing back 3D video, refer to the instructions provided in the manual of your playback device together with this manual.
- When playing back 3D video content, the menu screen or status display screen can be superimposed over the image. However, the menu screen or status display screen cannot be superimposed over certain 3D video content.
- If 3D video with no 3D information is input, the menu screen and status display on this unit are displayed over the playback video.
- If 2D video is converted to 3D video on the television, the menu screen and status display on this unit are not displayed correctly. To view the menu screen and status display on this unit correctly, turn the television setting that converts 2D video to 3D video off.

□ About 4K function

This unit supports input and output of 4K (3840 × 2160 pixels) video signals of HDMI.



When a device supporting 4K is connected, use a cable compatible with “High Speed HDMI cable” or “High Speed HDMI cable with Ethernet”.

□ HDMI control function (page 96)

This function allows you to operate external devices from the unit and operate the unit from external devices.

NOTE

- The HDMI control function may not work depending on the device it is connected to and its settings.
- You cannot operate a TV or Blu-ray Disc player/DVD player that is not compatible with the HDMI control function.
- The HDMI ZONE2 function is not compatible with the HDMI control function.

□ About Content Type

This function was added with the HDMI standard. It automatically makes settings suitable for the video-output type (content information).

NOTE

To enable the Content Type, set “Video Mode” to “Auto” (page 122).

□ Deep Color (page 171)

When a device supporting Deep Color is connected, use a cable compatible with “High Speed HDMI cable” or “High Speed HDMI cable with Ethernet”.

□ Auto Lip Sync (page 120, 171)

□ “x.v.Color”, sYCC601 color, Adobe RGB color, Adobe YCC601 color (page 171, 173)

□ High definition digital audio format

□ ARC (Audio Return Channel) (page 9)

Copyright protection system

In order to play back digital video and audio such as BD-Video or DVD-Video via HDMI connection, both this unit and TV or the player need to support the copyright protection system known as HDCP (High-bandwidth Digital Content Protection System). HDCP is copyright protection technology comprised of data encryption and authentication of the connected AV devices. This unit supports HDCP.

- If a device that does not support HDCP is connected, video and audio are not output correctly. Read the owner’s manual of your television or player for more information.

Settings related to HDMI connections

Set as necessary. For details, see the respective reference pages.

□ HDMI Setup (page 120)

Make settings for HDMI video/audio output.

- Auto Lip Sync
- HDMI Audio Out
- Video Output
- HDMI Control
- Standby Source
- Control Monitor
- Power Off Control

NOTE

The audio signal input from the HDMI input connector can be output as an output signal from the HDMI output connector by setting the HDMI audio output destination to TV.

Audio signals input via the Analog/Coaxial/Optical input connectors cannot be output from the HDMI MONITOR output connector.

Connecting an HDMI-incompatible device







For high quality video and surround playback, it is recommended to use an HDMI cable to connect this unit to TV and other video devices (see [page 8](#) "Connecting an HDMI-compatible device").

This section describes connections when your device does not support HDMI connections.

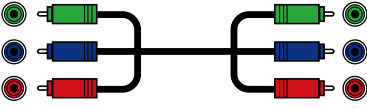
Connection methods for various devices

 TV	 page 14	 CBL/SAT	 page 15
 DVD	 page 16	 Blu-ray	 page 17
 AUX	 page 18	 MEDIA PLAYER	 page 19
 iPod/USB	 page 20	 CD	 page 21
 PHONO	 page 22	 TUNER	 page 23
 MI-XPort	 page 24	 NETWORK	 page 27

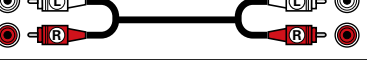
Cables used for connections

Video cable (sold separately)	
Component video cable	
Video cable	
Audio cable (sold separately)	
Coaxial digital cable	
Optical cable	
Audio cable	
Cable (sold separately)	
Ethernet cable	

Changing the source assigned to connectors

This unit can change the source that is assigned to the HDMI IN, DIGITAL AUDIO IN and COMPONENT VIDEO IN connectors.

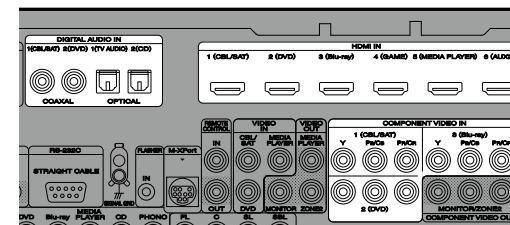

Let us take a digital audio connection for Blu-ray Disc players for an example. The rear panel digital audio input connectors do not have the input connector indication for Blu-ray disc players (Blu-ray). You can assign Blu-ray disc players to these connectors to use them for Blu-ray disc players. Select "Blu-ray" when switching functions on this unit to play back the source connected to these connectors.

- ❑ **How to change the source assigned to connectors** ( [page 126](#))

Connecting a TV

- This section describes how to connect when your TV does not support HDMI connections. For instructions on HDMI connections, see “Connecting an HDMI-compatible device” (page 8).
- If the TV connected to this unit is equipped with an HDMI connector that supports ARC, digital audio signals from TV can be transmitted to this unit (page 9 “About ARC (Audio Return Channel) function”). The ARC function allows you to enjoy on this unit the audio from TV programs and HDMI devices directly connected to TV, without having to make a separate audio connection. For the ARC function, also see your TV’s manual.
- To listen to TV audio through this device, use the optical digital connection.



For video connections, see “Converting input video signals for output (Video conversion function)” (page 6).

Audio connection

The following methods are available for connecting to this unit. **Use either of the methods to make a connection.**

1 DIGITAL AUDIO OPTICAL connector DIGITAL AUDIO COAXIAL connector *

When a multichannel audio (digital bit stream audio) is input, this unit decodes the audio to play back surround sound.

* When making this type of connection, you must change the settings on this unit.

(Input connector setting)

Video connection

The following methods are available for connecting to this unit. **Use either of the methods to make a connection.**

The numbers prefixed with connectors indicate the recommendation order. The smaller the number is, the higher playback quality is achieved.

1 COMPONENT VIDEO OUT (MONITOR) connector

This makes an analog video connection. This connection method separates video signals into 3 signals for transmission based on color components, achieving the best quality video playback among analog video connections, with less signal degradation.

2 VIDEO OUT (MONITOR) connector

This makes an analog video connection.

Input connector setting

When making the following connection, you must change the input connector settings.

1 DIGITAL AUDIO COAXIAL connector

When connecting to connectors marked as 1, change “CBL/SAT” to “TV AUDIO”.

For how to change, see “Input Assign” (page 126).

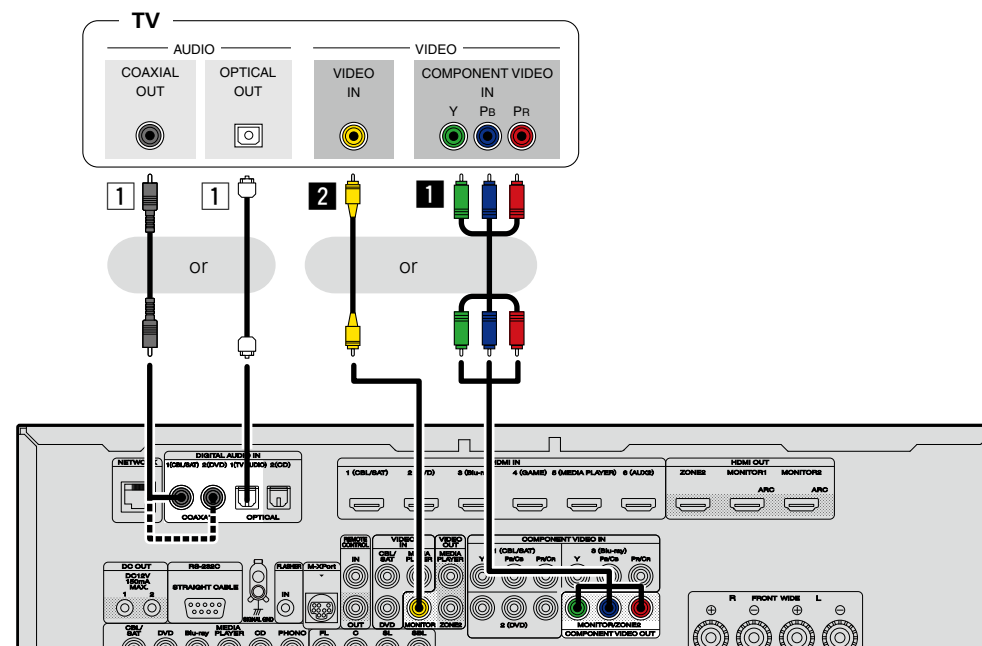

NOTE

- The menu screen is only displayed on TV connected to this unit via HDMI. If your TV is connected to this unit via other video output connectors, perform menu operations while seeing the display on this unit.
- If you do not connect this unit to your TV via HDMI, do not make HDMI connections for video inputs from other video devices, either. For details see “Converting input video signals for output (Video conversion function)” (page 6).

Connecting a set-top box (Satellite tuner/cable TV)

This section describes how to connect when your satellite tuner or cable TV does not support HDMI connections.

For instructions on HDMI connections, see “Connecting an HDMI-compatible device” ([page 8](#)).

Audio connection

The following methods are available for connecting to this unit. **Use either of the methods to make a connection.**

The numbers prefixed with connectors indicate the recommendation order. The smaller the number is, the higher playback quality is achieved.

1 DIGITAL AUDIO COAXIAL connector DIGITAL AUDIO OPTICAL connector *

When a multichannel audio (digital bit stream audio) is input, this unit decodes the audio to play back surround sound.

* When making this type of connection, you must change the settings on this unit.

([Input connector setting](#))

2 AUDIO IN (CBL/SAT) connector

This makes an analog audio connection. This type of connection converts digital audio to analog audio, so the output audio may be degraded compared to connections 1.

Video connection

The following methods are available for connecting to this unit. **Use either of the methods to make a connection.**

The numbers prefixed with connectors indicate the recommendation order. The smaller the number is, the higher playback quality is achieved.

1 COMPONENT VIDEO IN (CBL/SAT) connector

This makes an analog video connection. This connection method separates video signals into 3 signals for transmission based on color components, achieving the best quality video playback among analog video connections, with less signal degradation.

2 VIDEO IN (CBL/SAT) connector

This makes an analog video connection.

Input connector setting

When making the following connection, you must change the input connector settings.

1 DIGITAL AUDIO OPTICAL connector

When connecting to connectors marked as 1, change “TV AUDIO” to “CBL/SAT”.

For how to change, see “Input Assign” ([page 126](#)).

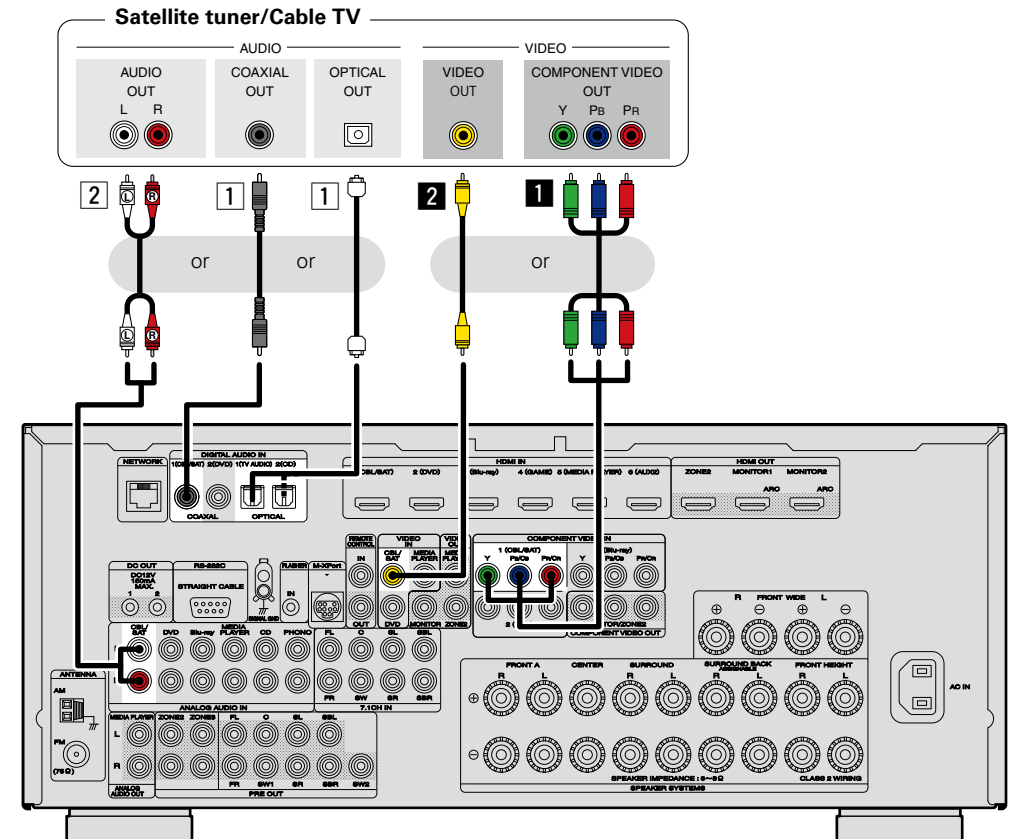

Connecting a DVD player

This section describes how to connect when your DVD player does not support HDMI connections. For instructions on HDMI connections, see "Connecting an HDMI-compatible device" ([page 8](#)).

Audio connection

The following methods are available for connecting to this unit. **Use either of the methods to make a connection.**

The numbers prefixed with connectors indicate the recommendation order. The smaller the number is, the higher playback quality is achieved.

1 DIGITAL AUDIO COAXIAL connector DIGITAL AUDIO OPTICAL connector *

When a multichannel audio (digital bit stream audio) is input, this unit decodes the audio to play back surround sound.

* When making this type of connection, you must change the settings on this unit.

([Input connector setting](#))

2 AUDIO IN (DVD) connector

This makes an analog audio connection. This type of connection converts digital audio to analog audio, so the output audio may be degraded compared to connections [1](#).

Video connection

The following methods are available for connecting to this unit. **Use either of the methods to make a connection.**

The numbers prefixed with connectors indicate the recommendation order. The smaller the number is, the higher playback quality is achieved.

1 COMPONENT VIDEO IN (DVD) connector

This makes an analog video connection. This connection method separates video signals into 3 signals for transmission based on color components, achieving the best quality video playback among analog video connections, with less signal degradation.

2 VIDEO IN (DVD) connector

This makes an analog video connection.

Input connector setting

When making the following connection, you must change the input connector settings.

1 DIGITAL AUDIO OPTICAL connector

When connecting to connectors marked as 1, change "TV AUDIO" to "DVD".

For how to change, see "Input Assign" ([page 126](#)).

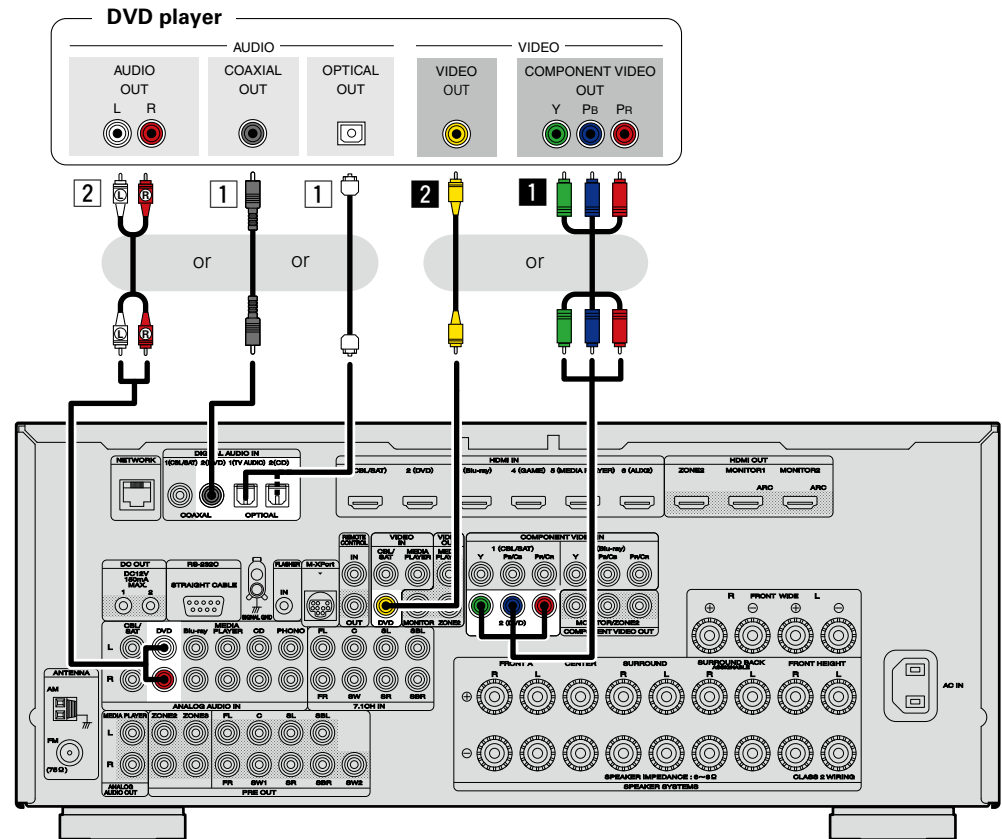

Connecting a Blu-ray Disc player

This section describes how to connect when your Blu-ray disc player does not support HDMI connections. For instructions on HDMI connections, see “Connecting an HDMI-compatible device” ([page 8](#)).

Audio connection

The following methods are available for connecting to this unit. **Use either of the methods to make a connection.**

The numbers prefixed with connectors indicate the recommendation order. The smaller the number is, the higher playback quality is achieved.

1 DIGITAL AUDIO COAXIAL connector DIGITAL AUDIO OPTICAL connector

When a multichannel audio (digital bit stream audio) is input, this unit decodes the audio to play back surround sound. However, digital bit stream audio signals for HD audios from Blu-ray disc players (such as Dolby Digital Plus and dts-HD) can not be transmitted.

When making this type of connection, you must change the settings on this unit.

([Input connector setting](#))

2 AUDIO IN (Blu-ray) connector

This makes an analog audio connection. This type of connection converts digital audio to analog audio, so the output audio may be degraded compared to connections 1.

Video connection

The following methods are available for connecting to this unit.

1 COMPONENT VIDEO IN (Blu-ray) connector

This makes an analog video connection. This connection method separates video signals into 3 signals for transmission based on color components, achieving the best quality video playback among analog video connections, with less signal degradation.

Input connector setting

When making the following connection, you must change the input connector settings.

1 DIGITAL AUDIO COAXIAL connector

When connecting to connectors marked as 1, change “CBL/SAT” to “Blu-ray”.

DIGITAL AUDIO OPTICAL connector

When connecting to connectors marked as 1, change “TV AUDIO” to “Blu-ray”.

For how to change, see “Input Assign” ([page 126](#)).

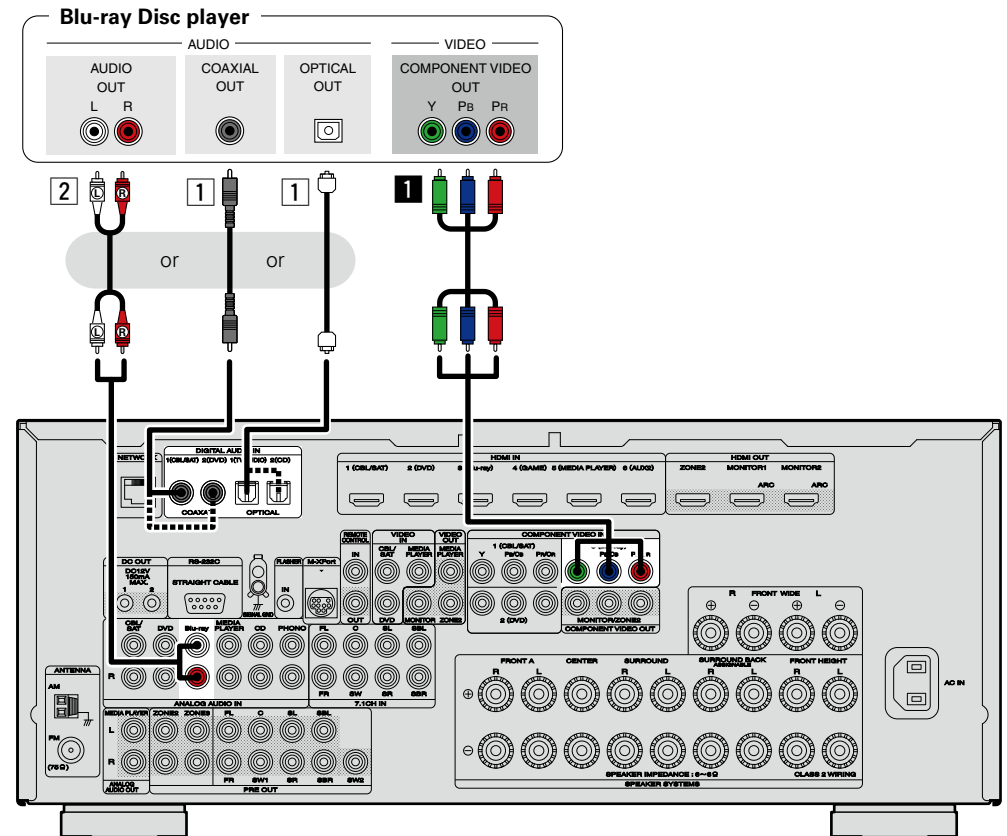

When you want to play back HD Audio (Dolby TrueHD, DTS-HD, Dolby Digital Plus, DTS Express) and Multi-channel PCM with this unit, use an HDMI connection ([page 8](#) “Connecting an HDMI-compatible device”).

Connecting a digital camcorder

This section describes how to connect when your digital camcorder does not support HDMI connections. For instructions on HDMI connections, see "Connecting an HDMI-compatible device" ([page 8](#)).

Audio connection

The following methods are available for connecting to this unit. **Use either of the methods to make a connection.**

The numbers prefixed with connectors indicate the recommendation order. The smaller the number is, the higher playback quality is achieved.

1 DIGITAL AUDIO COAXIAL connector DIGITAL AUDIO OPTICAL connector

When a multichannel audio (digital bit stream audio) is input, this unit decodes the audio to play back surround sound.

When making this type of connection, you must change the settings on this unit.

([Input connector setting](#))

2 AUDIO IN (AUX1) connector

This makes an analog audio connection. This type of connection converts digital audio to analog audio, so the output audio may be degraded compared to connections [1](#).

Video connection

The following methods are available for connecting to this unit. **Use either of the methods to make a connection.**

The numbers prefixed with connectors indicate the recommendation order. The smaller the number is, the higher playback quality is achieved.

1 COMPONENT VIDEO IN connector

This makes an analog video connection. This connection method separates video signals into 3 signals for transmission based on color components, achieving the best quality video playback among analog video connections, with less signal degradation.

When making this type of connection, you must change the settings on this unit.

([Input connector setting](#))

2 VIDEO IN (AUX1) connector

This makes an analog video connection.

Input connector setting

When making the following connection, you must change the input connector settings.

1 DIGITAL AUDIO COAXIAL connector

When connecting to connectors marked as 1, change "CBL/SAT" to "AUX2".

DIGITAL AUDIO OPTICAL connector

When connecting to connectors marked as 1, change "TV AUDIO" to "AUX2".

1 COMPONENT VIDEO IN connector

When connecting to connectors marked as 1, change "CBL/SAT" to "AUX2".

For how to change, see "Input Assign" ([page 126](#)).

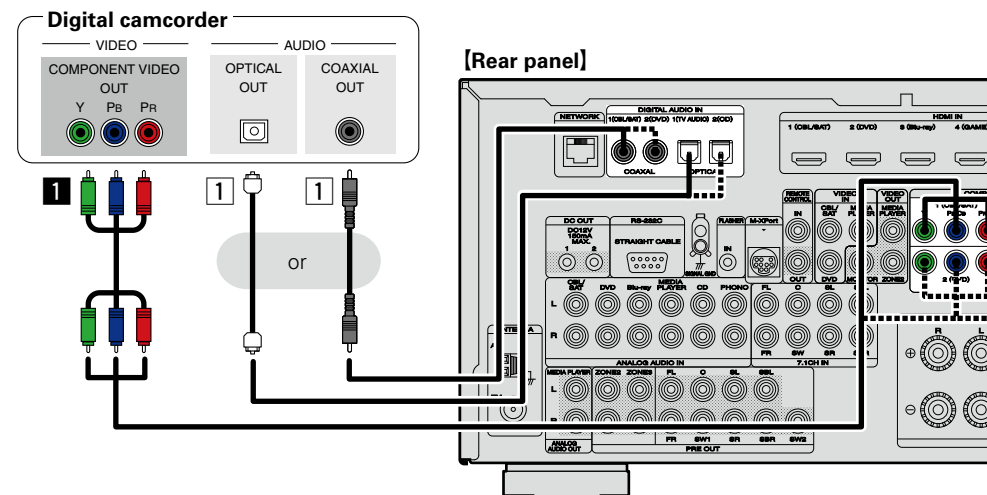
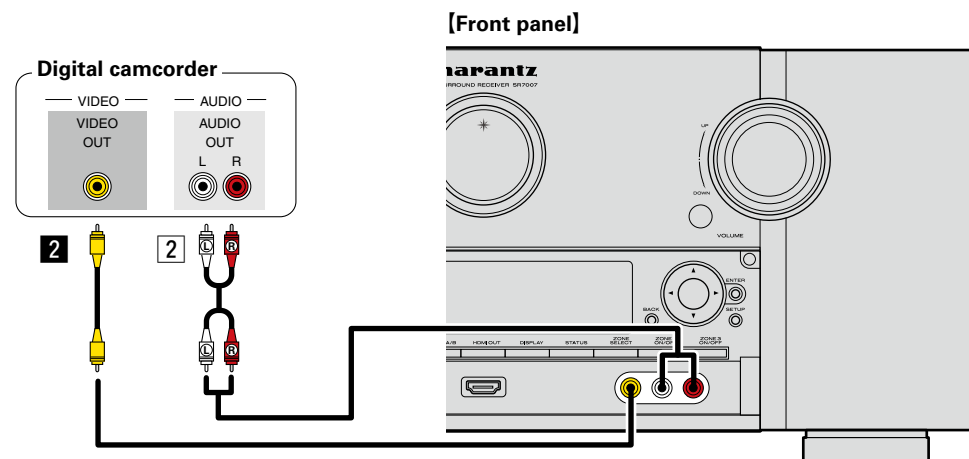

You can enjoy games by connecting a game machine via the AUX1 input connector. In this case, select the input source to "AUX1".

NOTE

When a non-standard video signal from a game machine or some other source is input, the video conversion function ([page 6](#)) might not operate. In this case, use the monitor output of the same connector as the input.

Connecting a media player

This section describes how to connect when your media player does not support HDMI connections. For instructions on HDMI connections, see “Connecting an HDMI-compatible device” ([page 8](#)).

Audio connection

The following methods are available for connecting to this unit. **Use either of the methods to make a connection.**

The numbers prefixed with connectors indicate the recommendation order. The smaller the number is, the higher playback quality is achieved.

1 DIGITAL AUDIO COAXIAL connector DIGITAL AUDIO OPTICAL connector

When a multichannel audio (digital bit stream audio) is input, this unit decodes the audio to play back surround sound.

When making this type of connection, you must change the settings on this unit.

([Input connector setting](#))

2 AUDIO IN (MEDIA PLAYER) connector

This makes an analog audio connection. This type of connection converts digital audio to analog audio, so the output audio may be degraded compared to connections [1](#).

Video connection

The following methods are available for connecting to this unit. **Use either of the methods to make a connection.**

The numbers prefixed with connectors indicate the recommendation order. The smaller the number is, the higher playback quality is achieved.

1 COMPONENT VIDEO IN connector

This makes an analog video connection. This connection method separates video signals into 3 signals for transmission based on color components, achieving the best quality video playback among analog video connections, with less signal degradation.

When making this type of connection, you must change the settings on this unit.

([Input connector setting](#))

2 VIDEO IN/OUT (MEDIA PLAYER) connector

This makes an analog video connection.

Input connector setting

When making the following connection, you must change the input connector settings.

1 DIGITAL AUDIO COAXIAL connector

When connecting to connectors marked as 1, change “CBL/SAT” to “MEDIA PLAYER”.

DIGITAL AUDIO OPTICAL connector

When connecting to connectors marked as 1, change “TV AUDIO” to “MEDIA PLAYER”.

1 COMPONENT VIDEO IN connector

When connecting to connectors marked as 1, change “CBL/SAT” to “MEDIA PLAYER”.

For how to change, see “Input Assign” ([page 126](#)).

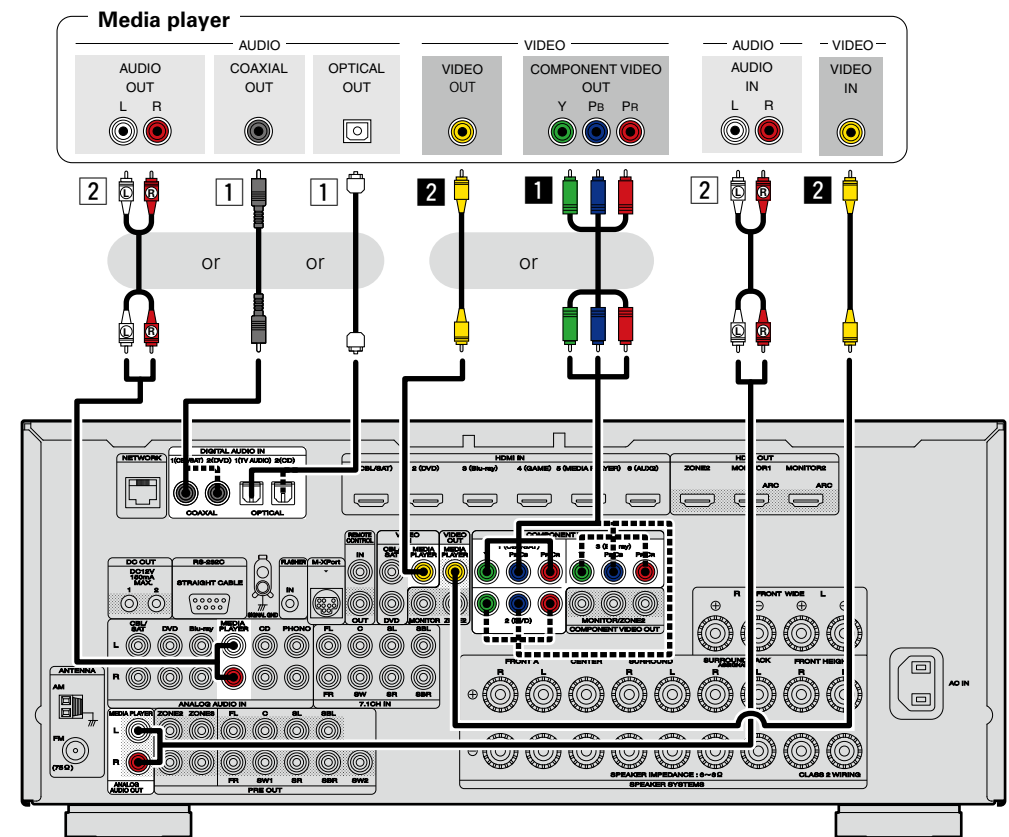

NOTE

To record video signals through this unit, use the video cable for connection between this unit and the player.

Connecting an iPod or USB memory device to the iPod/USB port

- You can enjoy music stored on an iPod or USB memory device.
- For operating instructions see “Playing an iPod” (page 39) or “Playing a USB memory device” (page 42).

Cables used for connections

To connect an iPod to this unit, use the USB cable supplied with the iPod.

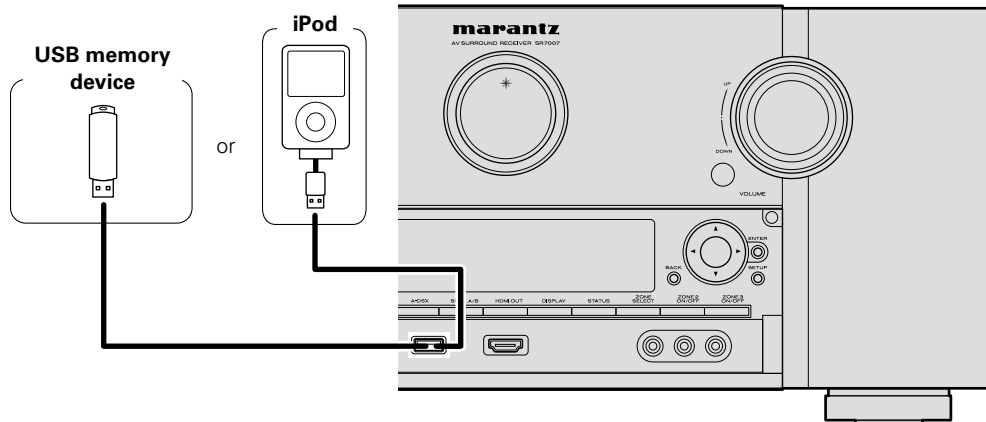

marantz does not guarantee that all USB memory devices will operate or receive power. When using a portable USB connection type HDD of the kind to which an AC adapter can be connected to supply power, use the AC adapter.

NOTE

- USB memory devices will not work via a USB hub.
- It is not possible to use this unit by connecting the unit's iPod/USB port to a PC via a USB cable.
- Do not use an extension cable when connecting a USB memory device. This may cause radio interference with other devices.
- When connecting an iPhone to this unit, keep the iPhone at least 20 cm away from this unit. If the iPhone is kept closer to this unit and a telephone call is received by the iPhone, noise may be output from this device.
- If the iPod is connected using an iPod cable (commercially available) that is longer than 6.6 ft (2 m), sound may not be played correctly. In this case, use a genuine iPod cable, or a cable that is shorter than 3.3 ft (1 m).

Supported iPod models

• iPod classic



iPod classic
80GB



iPod classic
160GB (2007)



iPod classic
160GB (2009)

• iPod nano



iPod nano
3rd generation
(video)
4GB 8GB



iPod nano
4th generation (video)
8GB 16GB



iPod nano
5th generation (video camera)
8GB 16GB



iPod nano
6th generation
8GB 16GB

• iPod touch



iPod touch
1st generation
8GB 16GB 32GB



iPod touch
2nd generation
8GB 16GB 32GB



iPod touch
3rd generation
32GB 64GB



iPod touch
4th generation
8GB 32GB 64GB

• iPhone



iPhone
4GB 8GB 16GB



iPhone 3G
8GB 16GB



iPhone 3GS
8GB 16GB 32GB



iPhone 4
8GB 16GB 32GB



iPhone 4S
16GB 32GB 64GB

(as of May 2012)

Connecting a CD player

You can enjoy CD sound.

Audio connection

The following methods are available for connecting to this unit. **Use either of the methods to make a connection.**

The numbers prefixed with connectors indicate the recommendation order. The smaller the number is, the higher playback quality is achieved.

1 DIGITAL AUDIO OPTICAL connector DIGITAL AUDIO COAXIAL connector *

When a multichannel audio (digital bit stream audio) is input, this unit decodes the audio to play back surround sound.

* When making this type of connection, you must change the settings on this unit.

(👉 **Input connector setting**)

2 AUDIO IN (CD) connector

This makes an analog audio connection. This type of connection converts digital audio to analog audio, so the output audio may be degraded compared to connections 1.

Input connector setting

When making the following connection, you must change the input connector settings.

1 DIGITAL AUDIO COAXIAL connector

When connecting to connectors marked as 1, change “CBL/SAT” to “CD”.

For how to change, see “Input Assign” (👉 [page 126](#)).

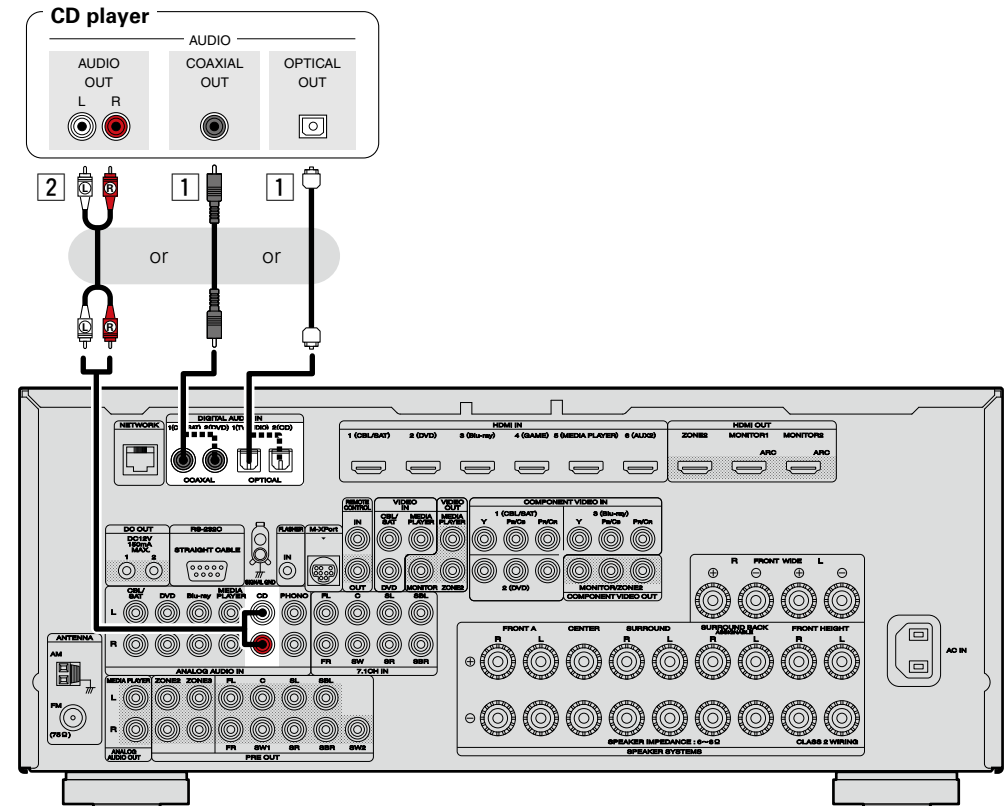

When you want to play back HD Audio (Dolby TrueHD, DTS-HD, Dolby Digital Plus, DTS Express), DSD and Multi-channel PCM with this unit, use an HDMI connection (👉 [page 8](#) “Connecting an HDMI-compatible device”).

Connecting a record player

You can enjoy playing records.

Audio connection

The following methods are available for connecting to this unit.

1 AUDIO IN (PHONO) connector

This makes an analog audio connection.



- This unit is compatible with record players with an MM cartridge. When you connect to a record player with an MC cartridge, use a commercially available MC head amp or a step-up transformer.
- If you set this unit's input source to "PHONO" and increase the volume without connecting the record player, there may be a "booming" noise from the speakers.

NOTE

The SIGNAL GND terminal of this unit is not a safety ground connection. Connect it to reduce noise when noise is excessive. Note that depending on the record player, connecting the ground line may have the reverse effect of increasing noise. In this case, it is not necessary to connect the ground line.

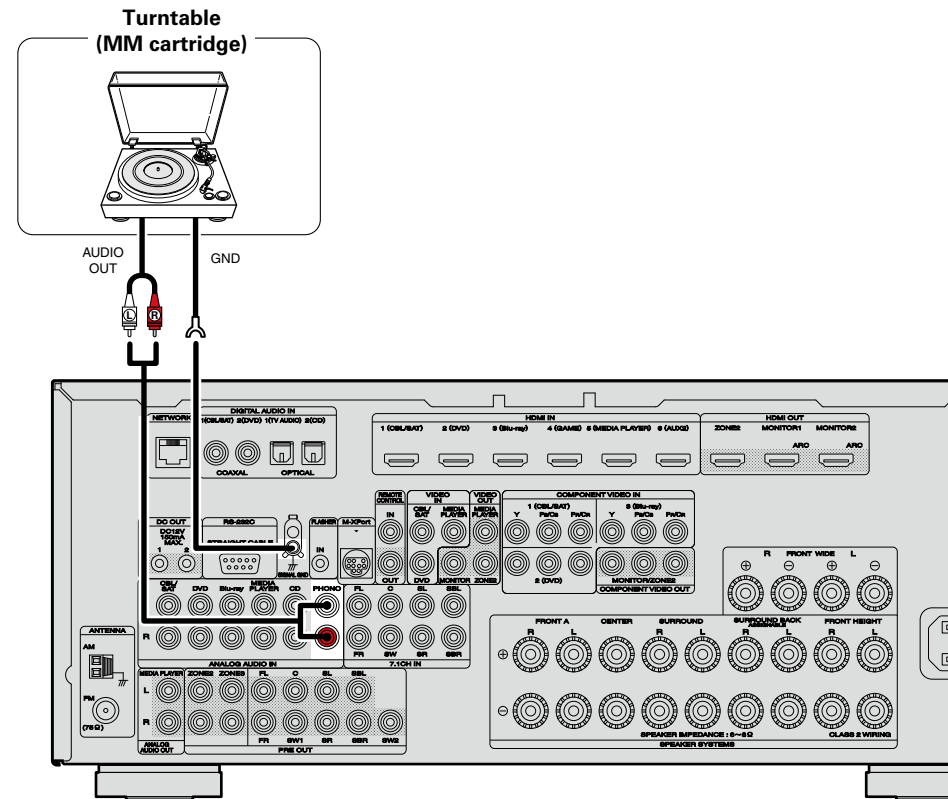

Connecting an HD Radio receiver

- By connecting a HD Radio antenna to this unit, you can receive HD Radio programs.
- HD Radio broadcasting currently is available in the United States and select other countries.
- After connecting the antenna and receiving a broadcast signal (see page 46 “Listening to HD Radio stations”), fix the antenna with tape in a position where the noise level becomes minimal.

AM loop antenna assembly

1 Put the stand section through the bottom of the loop antenna from the rear and bend it forward.

2 Insert the projecting part into the square hole in the stand.

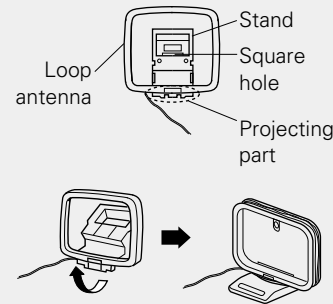

Using the AM loop antenna

Suspending on a wall

Suspend directly on a wall without assembling.

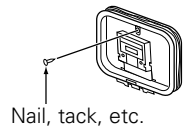

Nail, tack, etc.

Standing alone

Use the procedure shown above to assemble.

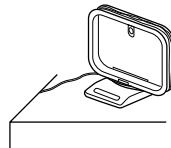

NOTE

- Do not connect two FM antennas simultaneously.
- Even if an external AM antenna is used, do not disconnect the AM loop antenna.
- Make sure the AM loop antenna lead terminals do not touch metal parts of the panel.
- If the signal has noise interference, connect the ground terminal (GND) to reduce noise.
- If you are unable to receive a good broadcast signal, we recommend installing an outdoor antenna. For details, inquire at the retail store where you purchased the unit.

Direction of broadcasting station

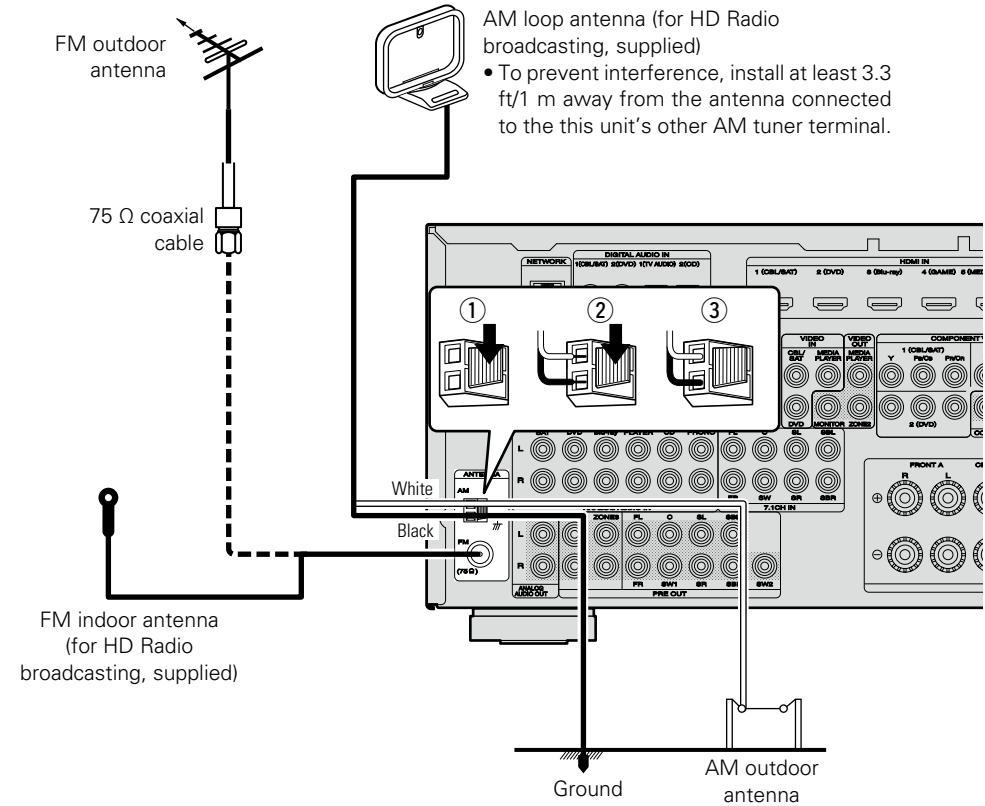

Connecting a wireless receiver (RX101)

- You can connect a wireless receiver (RX101, sold separately) to play back music on your Bluetooth device with this unit.
- To do this, switch the input source to "M-XPort" ([page 36](#) "Selecting the input source").
- This unit supports the A2DP standard of the Bluetooth profile.
- See also the manuals for your wireless receiver and Bluetooth device.



- When connecting your Bluetooth device to the wireless receiver for the first time, pairing is necessary. Once pairing is completed, the communication between your Bluetooth device and the wireless receiver can be established just by connecting them. Pairing is necessary for each Bluetooth device.
- You can also use the wireless receiver as an IR receiver. In this case, disable the remote control signal receiving function ([page 102](#) "Remote lock function").

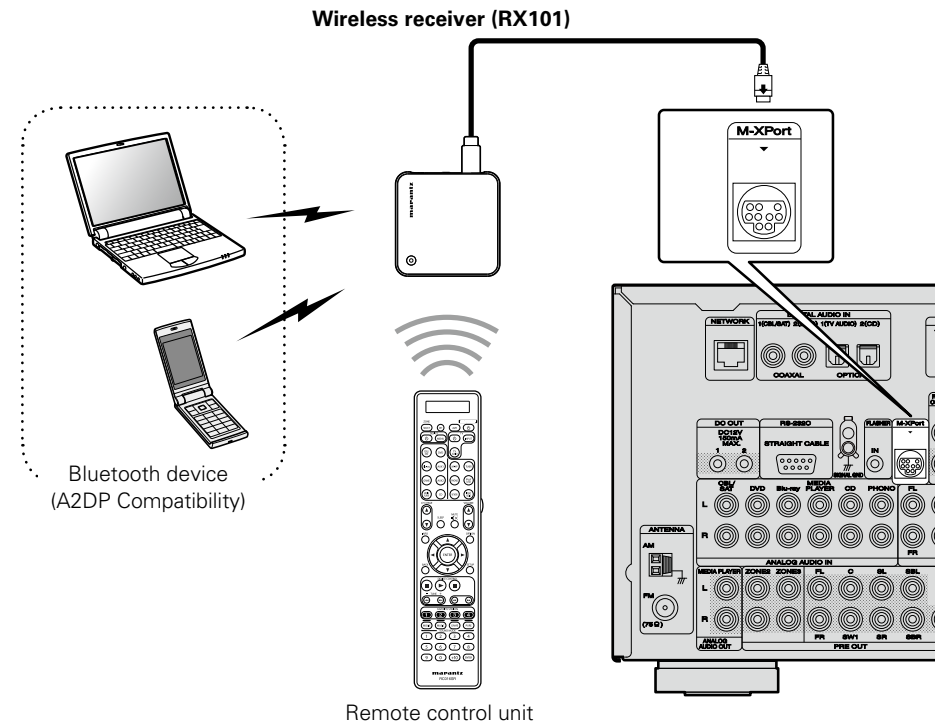

Connecting a device with a multi-channel output connector

- You can connect this unit to an external device fitted with multi-channel sound audio output connectors to enjoy music and video.
- To play analog signals input from 7.1CH IN connectors, set "Input Mode" ([page 128](#)) to "7.1CH IN".
- The video signal can be connected in the same way as a Blu-ray Disc player / DVD player ([page 16](#) "Connecting a DVD player", [page 17](#) "Connecting a Blu-ray Disc player").
- When a device is connected to the SBL/SBR terminal of 7.1CH IN connectors, set "Assign Mode" ([page 131](#)) to "Main Only".

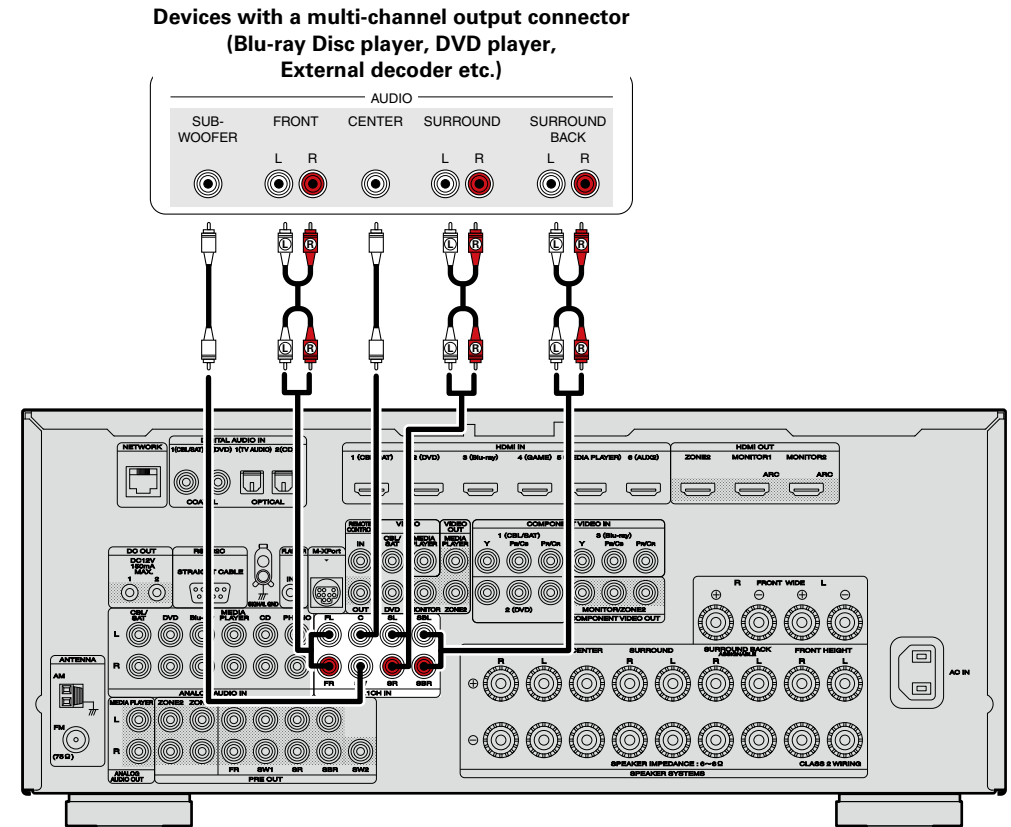

Connecting an external power amplifier

- You can use this unit as a pre-amp by connecting a commercially available power amp to the PRE OUT connector. Adding a power amp to each of the channels provides an even greater sound presence.
- Select the terminal to use and connect the device.



- When using just one surround back speaker, connect it to the left channel (L) terminal.
- Use the volume control on the subwoofer to control subwoofer volume.
- If the subwoofer volume sounds low, use the volume control provided on the subwoofer to adjust the volume.

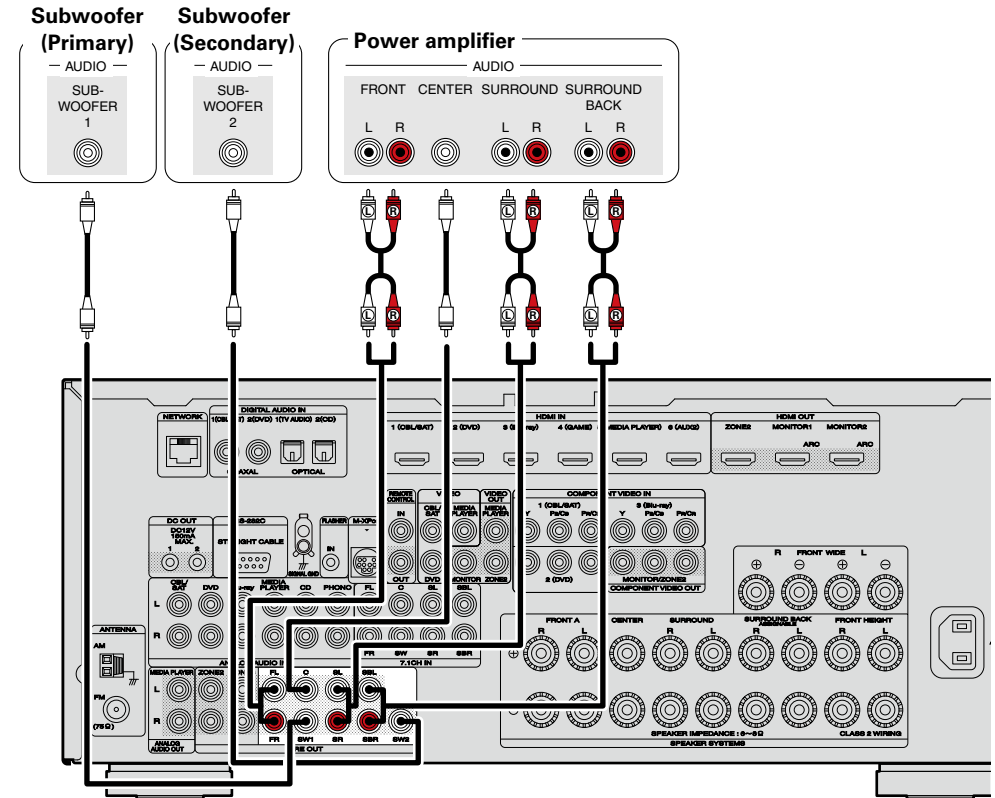

Connecting to a home network (LAN)

You can connect this unit to your home network (LAN) to perform various types of playbacks and operations as follows. Make network connections for this unit by carefully reading information on this page.

- Playback of network audio such as the Internet radio and music servers
- Playback of music from online services
- AirPlay
- Operations on this unit via the network

In addition, when an updated firmware becomes available for improving this unit, the update information is delivered from us to this unit over the network. You can then download the latest firmware. For more information, on the menu, select "Update" ([page 143](#)).

Network settings are necessary. See "Network" on the menu ([page 135](#)) for more information on network setting.

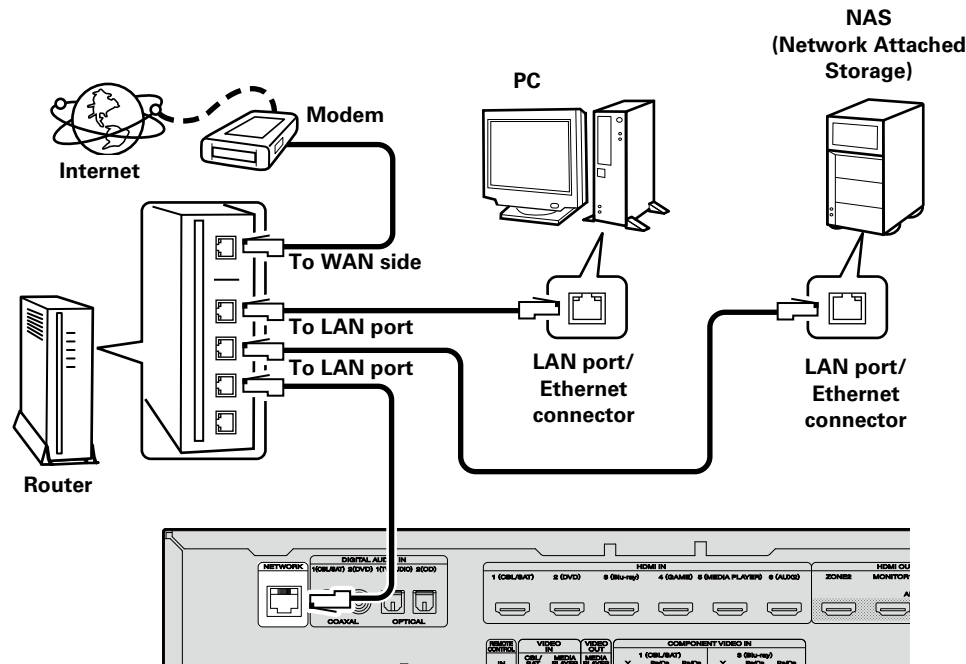

For connections to the Internet, contact an ISP (Internet Service Provider) or a computer shop.

Required system

Broadband internet connection

Modem

Device that connects to the broadband circuit and conducts communications on the Internet. A type that is integrated with a router is also available.

Router

When using this unit, we recommend you use a router equipped with the following functions:

- Built-in DHCP server
This function automatically assigns IP addresses on the LAN.
- Built-in 100BASE-TX switch
When connecting multiple devices, we recommend a switching hub with a speed of 100 Mbps or greater.

Ethernet cable (CAT-5 or greater recommended)

- Use only a shielded STP or ScTP LAN cable which is available at retailer.
- The normal shielded-type Ethernet cable is recommended. If a flat-type cable or unshielded-type cable is used, other devices could be affected by noise.



- If you have an Internet provider contract for a line on which network settings are made manually, make the settings at "Network" ([page 135](#)).
- With this unit, it is possible to use the DHCP and Auto IP functions to make the network settings automatically.
- When using this unit with the broadband router's DHCP function enabled, this unit automatically performs the IP address setting and other settings.
When using this unit connected to a network with no DHCP function, make the settings for the IP address, etc., at "Network" ([page 135](#)).
- When setting manually, check the setting contents with the network administrator.

NOTE

- A contract with an ISP is required to connect to the Internet.
No additional contract is needed if you already have a broadband connection to the Internet.
- The types of routers that can be used depend on the ISP. Contact an ISP or a computer shop for details.
- marantz assumes no responsibility whatsoever for any communication errors or troubles resulting from customer's network environment or connected devices.
- This unit is not compatible with PPPoE. A PPPoE-compatible router is required if you have a contract for a type of line set by PPPoE.
- Do not connect an NETWORK connector directly to the LAN port/ Ethernet connector on your computer.
- To listen to audio streaming, use a router that supports audio streaming.

Connecting the power cord

After completing all the connections, insert the power plug into the power outlet.

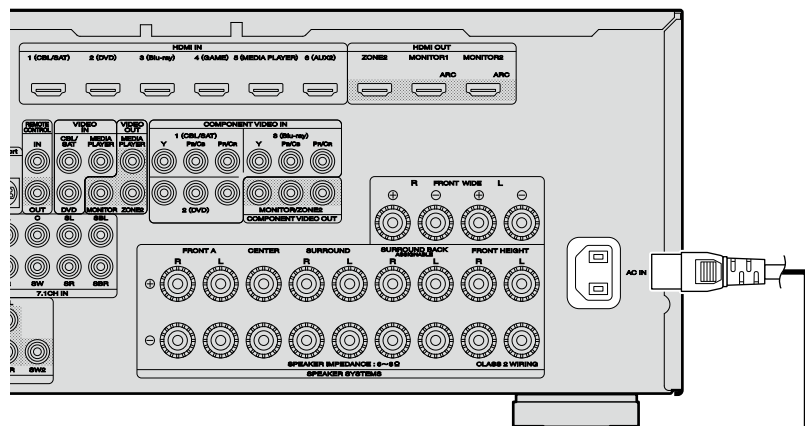

To household power outlet
(AC 120 V, 60 Hz)



Power cord (supplied)

NOTE

- Do not plug in the power cord until all connections have been completed.
- Do not bundle power cords together with connection cables. Doing so can result in humming or noise.

Setup

Here, we explain “Audyssey® Setup”, which allows you to automatically make the optimal settings for your speakers, and “Network”, which allows you to connect this unit to a home network (LAN).

This unit lets you play via your home network (LAN) music files stored on a computer and music content such as that from Internet radio.

❑ **Speaker connection** (👉 [page 84](#))

❑ **Set up speakers (Audyssey® Setup)** (👉 [page 29](#))

❑ **Making the network settings (Network)**
(👉 [page 35](#))

Playback (Basic operation) (👉 [page 36](#))

Selecting a listening mode (Sound Mode)
(👉 [page 75](#))

Playback (Advanced operation) (👉 [page 96](#))



Set up speakers (Audyssey® Setup)



The acoustic characteristics of the connected speakers and listening room are measured and the optimum settings are made automatically. This is called “Audyssey® Setup”.

To perform measurement, place the setup microphone in multiple locations all around the listening area. For best results, we recommend you measure in six or more positions, as shown in the illustration (up to eight positions).

- When performing Audyssey® Setup, Audyssey MultEQ® XT/Audyssey Dynamic EQ®/Audyssey Dynamic Volume® functions become active (👉 [page 116](#)).
- To set up the speakers manually, use “Speakers” (👉 [page 130](#)) on the menu.

NOTE

- Make the room as quiet as possible. Background noise can disrupt the room measurements. Close windows and turn off the power on electronic devices (TVs, radios, air conditioners, fluorescent lights, etc.). The measurements could be affected by the sounds emitted by such devices.
- During the measurement process, place cell phones outside the listening room. Cell phone signals could disrupt the measurements.
- Do not unplug the setup microphone from the main unit until Audyssey® Setup is completed.
- Do not stand between the speakers and setup microphone or allow obstacles in the path while the measurements are being made. This will cause inaccurate readings.
- During the measurement process, loud test sounds may be played, but this is part of normal operation. If there is background noise in room, these test signals will increase in volume.
- Operating **VOLUME ▲▼** on the remote control unit or **VOLUME** on the main unit during the measurements will cancel the measurements.
- Measurement cannot be performed when headphones are connected. Unplug the headphones before performing Audyssey® Setup.

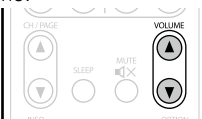

About setup microphone placement

- Measurements are performed by placing the setup microphone successively at multiple positions throughout the entire listening area, as shown in **[Example ①]**. For best results, we recommend you measure in six or more positions, as shown in the illustration (up to eight positions).
- Even if the listening environment is small as shown in **[Example ②]**, measuring at multiple points throughout the listening environment results in more effective correction.

[Example ①]

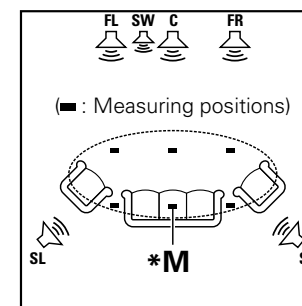

[Example ②]

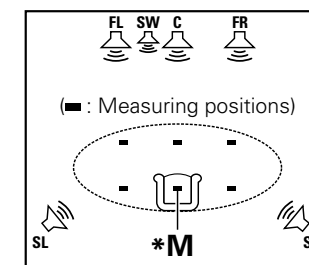

FL Front speaker (L)
FR Front speaker (R)
C Center speaker

SW Subwoofer
SL Surround speaker (L)
SR Surround speaker (R)

About the main listening position (*M)

The main listening position is the position where listeners would normally sit or where one would normally sit alone within the listening environment. Before starting Audyssey® Setup, place the setup microphone in the main listening position. Audyssey MultEQ® XT uses the measurements from this position to calculate speaker distance, level, polarity, and the optimum crossover value for the subwoofer.

1 Prepare the included setup microphone

Mount the setup microphone on a tripod or stand and place it in the main listening position.

When placing the setup microphone, adjust the height of the sound receptor to the level of the listener's ear.

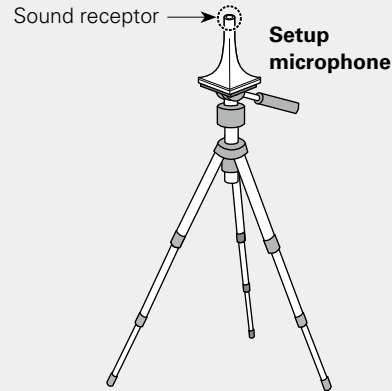

If you do not have a tripod or stand, set up the microphone on, for example, a seat without a back.

NOTE

- Do not hold the setup microphone in your hand during measurements.
- Avoid placing the setup microphone close to a seat back or wall as sound reflections may give inaccurate results.

2 Set up the subwoofer

If using a subwoofer capable of the following adjustments, set up the subwoofer as shown below.

For details, see your subwoofer's manual.

❑ When using a subwoofer with a direct mode

Set the direct mode to "On" and disable the volume adjustment and crossover frequency setting.

❑ When using a subwoofer without a direct mode

Make the following settings:

- **Volume** : "12 o'clock position"
- **Crossover frequency** : "Maximum/Highest Frequency"
- **Low pass filter** : "Off"
- **Standby mode** : "Off"

NOTE

When using 2 subwoofers at the same time, before starting Audyssey® Setup, adjust the volume of the subwoofers by using "Subwoofer Level" ([page 115](#)) from the menu. You cannot set the volume for individual subwoofers.

3 Set up the remote control unit

❑ Set up the zone mode

Press **ZONE SELECT** to switch "MAIN".

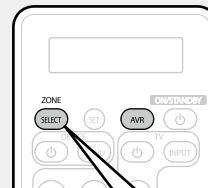

Press **ZONE SELECT**

NOTE

When using a remote control with preset codes registered ([page 148](#)), press **AVR** to set the remote control to the AVR-operation mode before operation.

Preparation

4 Connect the setup microphone to the SETUP MIC jack of this unit.

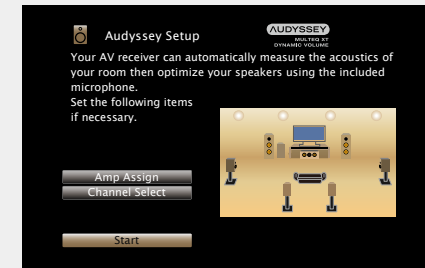
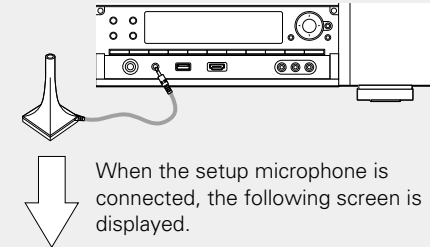

- Here, we explain setup using the example of 7.1-channel speaker playback using surround back speakers. For setup of surround back speaker systems other than 7.1-channels, follows steps 3 to 6 in "Set up "Amp Assign"" ([page 91](#)). If unused channels are set with "Channel Select", measuring time can be shortened. For setting, perform steps 7 to 13 of "Set up "Channel Select"" ([page 92](#)).

Preparation (Continued)

5 Select “Start” and then press ENTER.

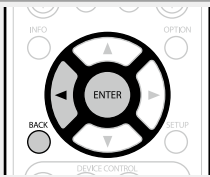

6 Select “Next” and then press ENTER.

The subwoofer volume setting screen is displayed.

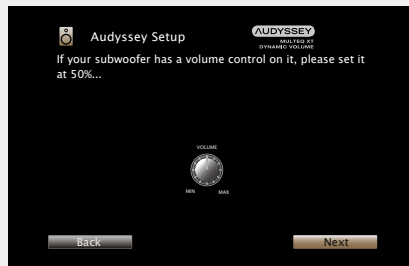

Detection & Measurement (Main)

- This step automatically checks the speaker configuration and speaker size, and calculates the channel level, distance, and crossover frequency. It also corrects distortion in the listening area.

7 Select “Begin Test” and then press ENTER.

When measuring begins, a test tone is output from each speaker.

- Measurement requires several minutes.

8 The detected speakers are displayed.

- The illustration below shows an example of when the front speakers, center speaker, subwoofer, surround speakers and surround back speakers have been detected.

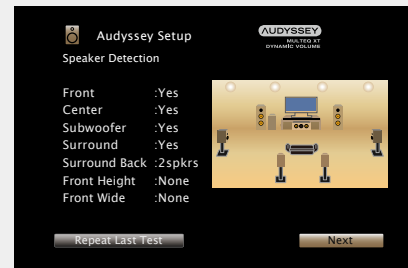

NOTE

If a connected speaker is not displayed, the speaker may not be connected correctly. Check the speaker connection.

9 Select “Next” and then press ENTER.

NOTE

If “Caution!” is displayed on TV screen:

Go to “Error messages” ([page 34](#)). Check any related items, and perform the necessary procedures.

If the problem is resolved, return and restart “Audyssey® Setup”.

Going back to the previous screen

Select “Back” and then press ENTER.

When measuring has stopped

- Press **BACK** to display the popup screen.
- Press **<** to select “Yes”, and then press **ENTER**.

Setting up the speakers again

Repeat the operation from step 4.

Measurement (2nd – 8th)

- In this step, you will perform measurements at multiple positions (two to eight positions) other than the main listening position.
- Just one position can be measured but measuring multiple positions increases the accuracy of the correction of acoustic distortion within the listening area.

10 Move the setup microphone to position 2, select “Continue”, and then press ENTER.

The measurement of the second position starts. Measurements can be made in up to eight positions.

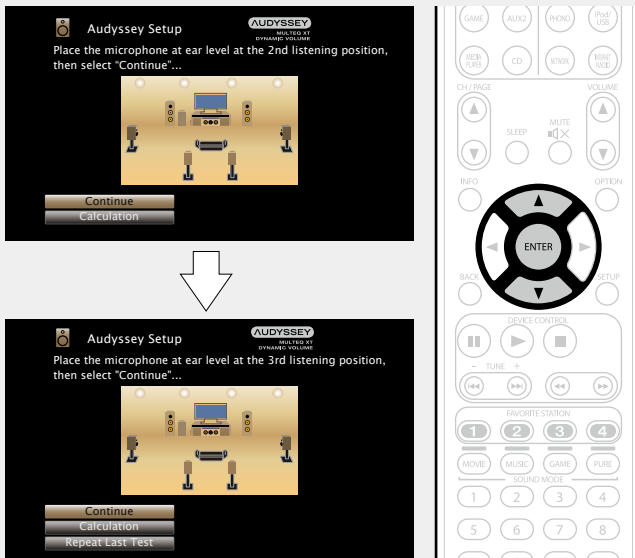

- To skip measuring the third and subsequent listening position, use $\Delta \nabla$ to select “Calculation” and press **ENTER** to proceed to step 13.
- To measure the second position again, use $\Delta \nabla$ to select “Repeat Last Test” and press **ENTER**.

Calculation

11 Repeat step 10, measuring positions 3 to 8.

When measurement of position 8 is completed, a “Measurements finished.” message is displayed.

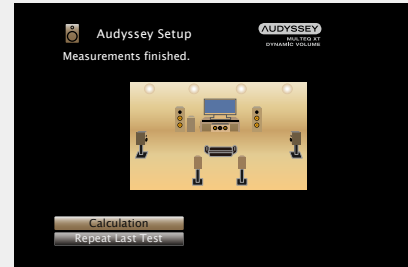

12 Select “Calculation” and then press ENTER.

Measuring results are analyzed, and the frequency response of each speaker in the listening room is determined.

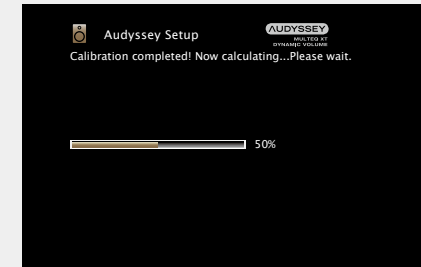

- Analysis takes several minutes to complete. The more speakers and measurement positions that there are, the more time it takes to perform the analysis.

Check

13 Use Δ / ∇ to select the item you want to check, and then press **ENTER**.

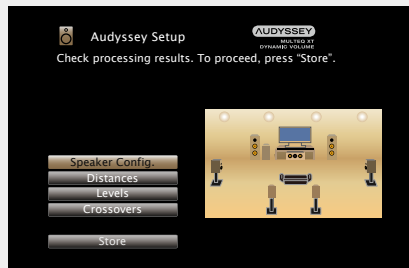
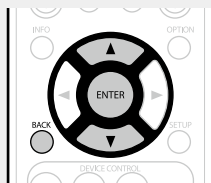

- Subwoofers may measure a greater reported distance than the actual distance due to added electrical delay common in subwoofers.
- If you want to check another item, press **BACK**.

NOTE

- If the result differs from the actual connection status, or if "Caution!" is displayed, see "Error messages" ([page 34](#)). Then carry out Audyssey® Setup again.
- If you change speaker positions or orientation, perform Audyssey® Setup again to find the optimal equalizer settings.

Store

14 Select "Store" and then press **ENTER**.
Save the measurement results.

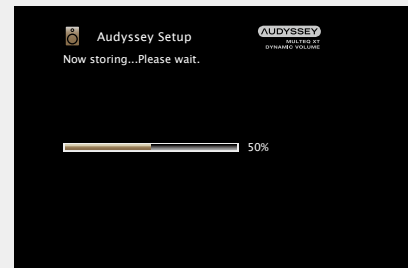
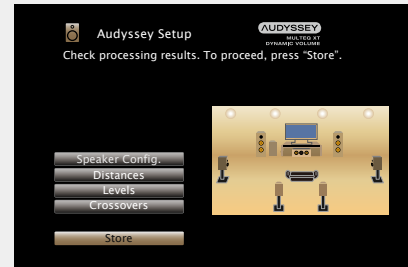

- Saving the results requires about 10 seconds.
- During saving of measurements results, "Now storing...Please wait." is displayed. When saving is completed, "Storing complete. Audyssey® Setup is now finished. Please unplug microphone." is displayed.

NOTE

During saving of measurement results, be sure not to turn off the power.

Finish

15 Unplug the setup microphone from the unit's **SETUP MIC** jack.

16 Set Audyssey Dynamic Volume®.

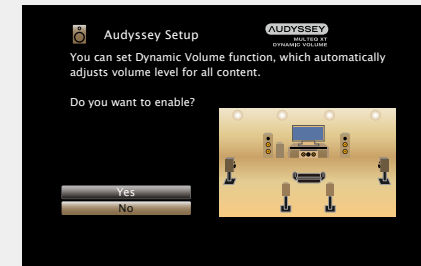

- This feature adjusts the output volume to the optimal level while constantly monitoring the level of the audio input to the unit. Optimal volume control is performed automatically without any loss in the dynamism and clarity of the sound when, for example, the volume suddenly increases for commercials shown during television programs.

 When turning Dynamic Volume on

- Press Δ to select "Yes", and then press **ENTER**.
The unit automatically enters "Medium" ([page 117](#)) mode.

 When turning Dynamic Volume off

- Press ∇ to select "No", and then press **ENTER**.

NOTE

After performing Audyssey® Setup, do not change the speaker connections or subwoofer volume. In event of a change, perform Audyssey® Setup again.

Error messages

NOTE

- An error message is displayed if Audyssey® Setup could not be completed due to speaker placement, the measurement environment, etc. If an error message is displayed, check the relevant items and perform the necessary measures. Then perform Audyssey® Setup again.
- If the result still differs from the actual connection status after remeasurement or the error message still appears, it is possible that the speakers are not connected properly. Turn this unit off, check the speaker connections and repeat the measurement process from the beginning.
- Be sure to turn off the power before checking speaker connections.

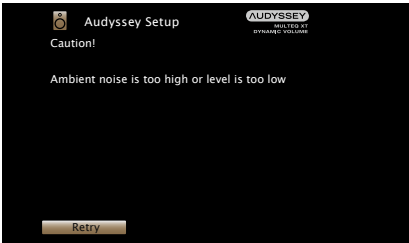
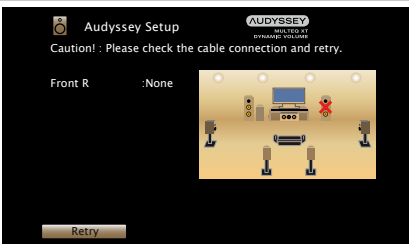
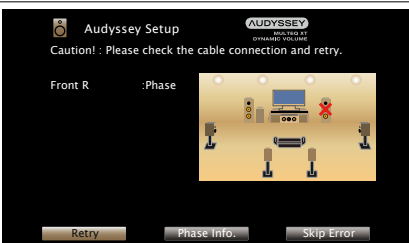
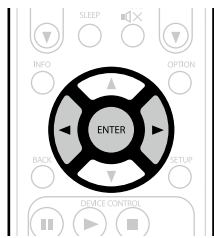
Examples	Error details	Measures
 <p>Audyssey Setup CAUTION! : Please check the cable connection and retry. Microphone or Speaker is none Retry</p>	<ul style="list-style-type: none"> • The connected setup microphone is broken, or a device other than the supplied setup microphone is connected. • Not all speakers could be detected. 	<ul style="list-style-type: none"> • Connect the included setup microphone to the SETUP MIC jack of this unit. • Check the speaker connections.
 <p>Audyssey Setup CAUTION! Ambient noise is too high or level is too low Retry</p>	<ul style="list-style-type: none"> • There is too much noise in the room for accurate measurements to be made. • Speaker or subwoofer sound is too low for accurate measurements to be made. 	<ul style="list-style-type: none"> • Either turn off any device generating noise or move it away. • Perform again when the surroundings are quieter. • Check the speaker installation and the direction in which the speakers are facing. • Adjust the subwoofer's volume.
 <p>Audyssey Setup CAUTION! : Please check the cable connection and retry. Front R :None Retry</p>	<ul style="list-style-type: none"> • The displayed speaker could not be detected. (The screen on the left indicates that the front right speaker cannot be detected.) 	<ul style="list-style-type: none"> • Check the connections of the displayed speaker.
 <p>Audyssey Setup CAUTION! : Please check the cable connection and retry. Front R :Phase Retry Phase Info. Skip Error</p>	<ul style="list-style-type: none"> • The displayed speaker is connected with the polarity reversed. (The screen on the left indicates that the polarity phases of the front right speakers are reversed.) 	<ul style="list-style-type: none"> • Check the polarity of the displayed speaker. • For some speakers, this error message may be displayed even if the speaker is properly connected. If you are sure the connection is correct, use ◀▶ to select "Skip Error", then press ENTER. 

Parameter Check

This function enables you to check the measurement results and equalizer characteristics after Audyssey® Setup.

1 Use Δ / ∇ to select “Parameter Check” and then press ENTER.

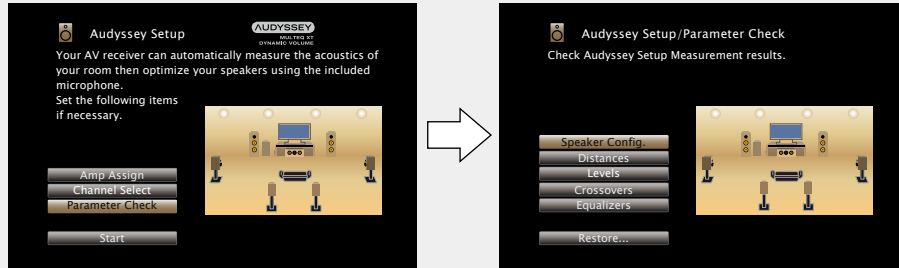

2 Use Δ / ∇ to select the item you want to check, then press ENTER.

Measurement results for each speaker are displayed.

Speaker Config.	Check the speaker configuration.
Distances	Check the speaker distance.
Levels	Check the speaker channel level.
Crossovers	Check the speaker crossover frequency.
Equalizers	Check the equalizer.

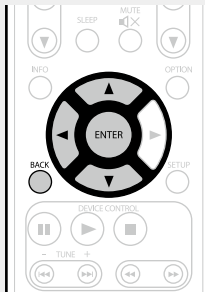

- If “Equalizers” is selected, press Δ / ∇ to select equalizing curve (“Audyssey” or “Audyssey Flat”) to be checked.
Use Δ / ∇ to switch the display between the different speakers.

3 Press \triangleleft or BACK.

The confirmation screen reappears. Repeat step 2.

Retrieving Audyssey® Setup settings

If you set “Restore...” to “Yes”, you can return to Audyssey® Setup measurement result (value calculated at the start by MultEQ® XT) even when you have changed each setting manually.



Making the network settings (Network)



This unit can be connected to a home network (LAN) to listen to Internet radio or play back music files and still image (JPEG) files stored on a computer.

1 Connect the Ethernet cable (☞ page 27 “Connecting to a home network (LAN)”).

2 Turn on this unit (☞ page 36).

This unit performs automatic network setup due to the DHCP function.
When connecting to a network that has no DHCP function, perform the setting in “Settings” (☞ page 137).

Playback (Basic operation)

Setup (page 29)

- ❑ Turning the power on (page 36)
- ❑ Selecting the input source (page 36)
- ❑ Adjusting the master volume (page 37)
- ❑ Turning off the sound temporarily (page 37)

- ❑ Playing a Blu-ray Disc player/DVD player (page 37)
- ❑ Playing Super Audio CD (page 37)
- ❑ Playing a CD player (page 38)
- ❑ Playing an iPod (page 39)
- ❑ Playing a USB memory device (page 42)
- ❑ Listening to HD Radio stations (page 45)

- ❑ Listening to internet radio (page 54)
- ❑ Playing back files stored on a PC and NAS (page 57)
- ❑ Using online services (page 61)
- ❑ Convenient functions (page 69)
- ❑ AirPlay function (page 73)

Selecting a listening mode (Sound Mode) (page 75)

Playback (Advanced operation) (page 96)

Important information

Before starting playback, make the connections between the different devices and the settings on the unit.

NOTE

Also refer to the operating instructions of the connected devices when playing them.

Turning the power on

Press **ON/STANDBY**  to turn on power to the unit.
The power turns on.

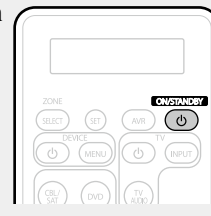

You can also switch the power to standby by pressing **ON/STANDBY**  on the main unit.

❑ When power is switched to standby

Press **ON/STANDBY** .

[STANDBY indicator status in standby mode]

- Normal standby : Red
- When "HDMI Control" (page 121) is set to "On" : Orange
- When "IP Control" (page 136) is set to "Always On" : Orange

Selecting the input source

Press the input source select button (**CBL/SAT, DVD, Blu-ray, AUX1, M-XP, TUNER, GAME, AUX2, PHONO, iPod/USB, MEDIA PLAYER, CD, NETWORK or INTERNET RADIO**) to be played back.

The desired input source can be selected directly.



You can also use the following operation to select an input source.

❑ Select the input source using the main unit

Turn **INPUT SELECTOR**.

- Turning **INPUT SELECTOR** switches the input source, as shown below.

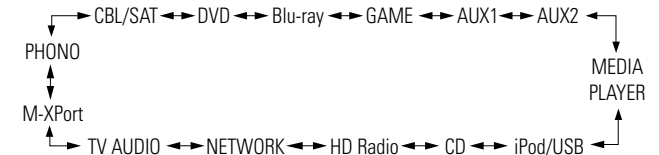

Adjusting the master volume

Use **VOLUME ▲▼** to adjust the volume.

- The volume display method varies depending on the "Scale" setting (☞ [page 116](#)).

☐ When the "Scale" setting (☞ [page 116](#)) is "0 – 98"

[Adjustable range] 0.0 0.5 – 98.0

☐ When the "Scale" setting (☞ [page 116](#)) is "–79.5dB – 18.0dB"

[Adjustable range] ---- –79.5dB – 18.0dB

- The variable range differs according to the input signal and channel level setting.



You can also adjust the master volume by turning **VOLUME** on the main unit.

Turning off the sound temporarily

Press **MUTE** .

- "MUTE" indicator on the display flashes.
-  appears on a TV screen.



- The sound is reduced to the level set at "Mute Level" (☞ [page 116](#)).
- To cancel, press **MUTE**  again. Muting can also be canceled by adjusting the master volume.

Playing a Blu-ray Disc player/DVD player

The following describes the procedure for playing Blu-ray Disc player/DVD player.

1 Prepare for playback.

- Turn on the power of the TV, subwoofer and player.
- Change the TV input to the input of this unit.
- Load the disc in the player.

2 Press ON/STANDBY to turn on power to the unit.

3 Press Blu-ray or DVD to switch an input source for a player used for playback.

4 Play the Blu-ray Disc player or DVD player.

- Make the necessary settings on the player (language setting, subtitles setting, etc.) beforehand.

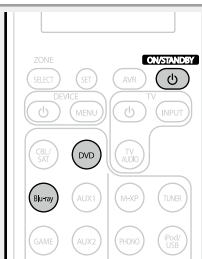

Playing Super Audio CD

The following describes the procedure for playing Super Audio CD.

1 Prepare for playback.

- Turn on the power of the subwoofer and player.
- Load the disc in the player.

2 Press ON/STANDBY to turn on power to the unit.

3 Perform the settings of the "Input Assign" menu (☞ [page 126](#)).

Assign HDMI connectors for the input source (example: DVD).

4 Press the input source select button (example: DVD) to switch an input source assigned in step 3 - ①.

5 Set the audio input mode to "Auto" using the "Input Mode" menu (☞ [page 128](#)).

- The default setting of "Input Mode" is "Auto".

6 Play the component connected to this unit.

The **[DSD]** indicator lights on the display.



When playing back Super Audio CD, DSD signals are converted into PCM signals which are then converted into analog signals.

Playing a CD player

The following describes the procedure for playing CD player.

1 Prepare for playback.

- ① Turn on the power of the subwoofer and player.
- ② Load the disc in the player.

2 Press **ON/STANDBY** to turn on power to the unit.

3 Press **CD** to switch the input source to “CD”.

4 Play the CD player.



Playing an iPod

You can use the USB cable provided with the iPod to connect the iPod with the unit's iPod/USB port and enjoy music stored on the iPod.

For information on the iPod models that can be played back with this unit, see "Connecting an iPod or USB memory device to the iPod/USB port" ([page 20](#)).

Listening to music on an iPod

The iPod display modes include "Direct Mode" and "Remote Mode". By default, "Direct Mode", where you directly operate iPod itself while seeing the iPod screen, is set.

To change to "Remote Mode", where you perform operations while having the iPod information displayed on the TV screen, see "Setting "Remote Mode" (Operation Mode)" ([page 40](#)).

1 Using the USB cable provided with the iPod, connect the iPod to the iPod/USB port ([page 20](#)).

2 Press **ON/STANDBY**  to turn on power to the unit.

3 Press **iPod/USB** to switch the input source to "iPod/USB".
"Remote iPod" is displayed on the display of this unit.

• Nothing is displayed on the TV screen.

4 Operate iPod itself directly while seeing the iPod screen to play back music.

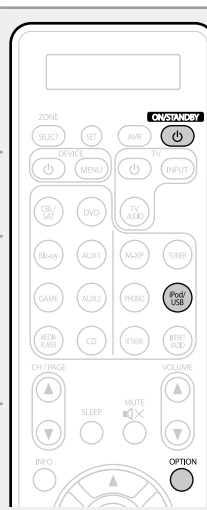

- Streaming music stored in iPhone, iPod touch, or iPad directly to the unit ([page 73](#))
- Playing iTunes music with this unit ([page 73](#))

Operations available through the OPTION button

Press the **OPTION** button to display a menu of functions that can be used on the TV screen. Select the function you want to use from this menu. You can easily find and use the desired function.

Setting "Remote Mode" (Operation Mode)
([page 40](#))

Performing repeat playback (Repeat)
([page 41](#))

Performing random playback (Random)
([page 41](#))

❑ Setting “Remote Mode” (Operation Mode)

In this mode, various lists and screens during playback on iPod are displayed on the TV screen.
This section describes the steps up to playing back tracks on iPod in “Remote Mode”.

1 Press **iPod/USB** to switch the input source to “iPod/USB”.

2 Press **OPTION**.
The option menu screen is displayed.

3 Select “Operation Mode”, then press **ENTER**.
The “Operation Mode” screen is displayed.

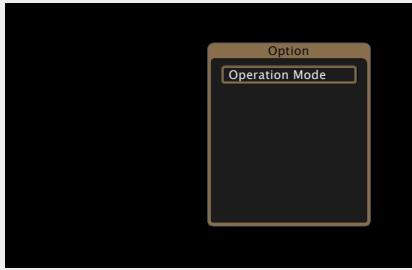

4 Use **◀ ▶** to select “Remote Mode”, then press **ENTER**.
The iPod screen is displayed.



- English letters, numbers and certain symbols are displayed. Incompatible characters are displayed as “.” (period).
- Operations available for “Direct Mode” and “Remote Mode” are listed below.

Display mode		Direct Mode	Remote Mode
Playable files	Music file	✓	✓
	Video file	*	
Active buttons	Remote control unit (This unit)	✓	✓
	iPod	✓	

* Only the sound is played.

5 Use **△▽** to select the item, then press **ENTER** or **▶** to select the file to be played.

6 Press **ENTER**, **▶** or **▶▶**.
Playback starts.

❑ Adjusting the sound quality (M-DAX)

Make this setting at “M-DAX” ([page 115](#)) in the menu.
You can use the “M-DAX” function to restore to a state close to the audio before compression while correcting the bass feel to enjoy a richer playback experience. The default setting is “Off”.

❑ Changing the screen display duration

Make this setting at “Audio Display” ([page 124](#)) in the menu.
The default setting is “30s”.
Press **△▽◀▶** while the display is off to return to the original screen.

❑ Switching the screen display

In Remote Mode, press **STATUS** on the main unit during playback.
The display switches between track title, artist name, and album title etc. each time the button is pressed.

NOTE

- Depending on the type of iPod and the software version, some functions may not operate.
- Note that marantz will accept no responsibility whatsoever for any problems arising with the data on an iPod when using this unit in conjunction with the iPod.

□ Performing repeat playback (Repeat)

1 Press **OPTION** while in Remote Mode.
The option menu screen is displayed.

2 Use $\Delta \nabla$ to select “Repeat”, then press **ENTER**.

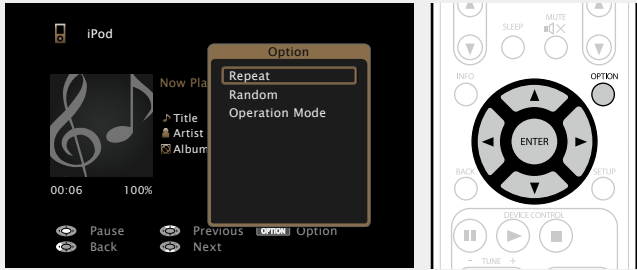

3 Use $\triangleleft \triangleright$ to select repeat playback mode.

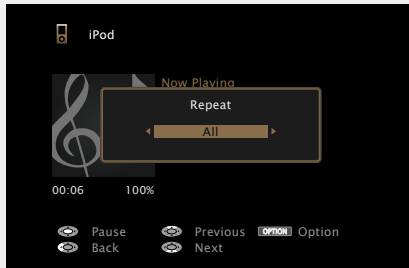

• Each time $\triangleleft \triangleright$ is pressed, the setting is changed as shown below.



Off Repeat playback mode is canceled.

One A file being played is played repeatedly.

All All files in the folder currently being played are played repeatedly.

4 Press **ENTER**.
The display returns to the playback screen.

□ Performing random playback (Random)

1 Press **OPTION** while in Remote Mode.
The option menu screen is displayed.

2 Use $\Delta \nabla$ to select “Random”, then press **ENTER**.

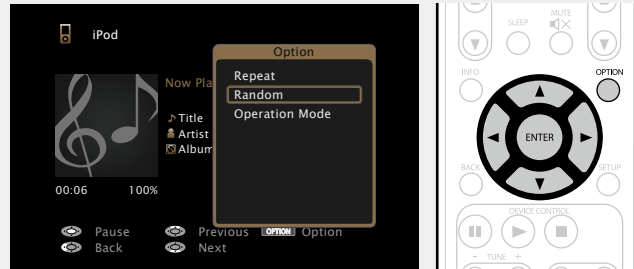

3 Use $\triangleleft \triangleright$ to select random playback mode.

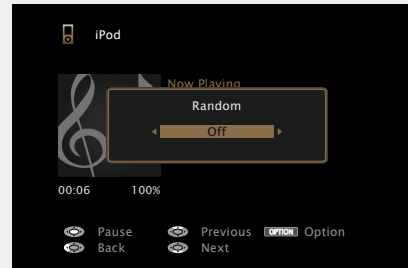

• Each time $\triangleleft \triangleright$ is pressed, the setting is changed as shown below.

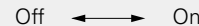

Off Disable random playback.

On Enable random playback.

4 Press **ENTER**.
The display returns to the playback screen.



The random playback randomly selects a track to play back from all tracks every time a track ends. Therefore, the same track may be played back consecutively.

□ iPod operation buttons

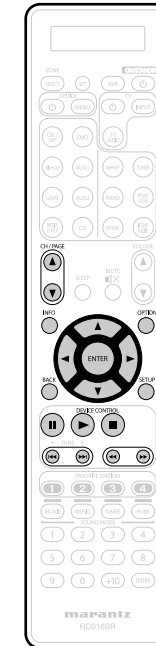

Operation buttons	Function
CH/PAGE $\Delta \nabla$	Page search
INFO	Display of information such as the source name, volume, and sound mode name
OPTION	Remote / Direct Mode switching / Repeat playback / Random playback
$\Delta \nabla \triangleleft \triangleright$	Cursor operation / Auto search (cue, $\Delta \nabla$) / Manual search (Press and hold, $\Delta \nabla$)
ENTER (Press and release)	Enter
ENTER (Press and hold)	Stop
BACK	Return
SETUP	Setup
II	Pause
\blacktriangleright	Playback / Pause
\blacksquare	Stop
$\lll \lll \lll \lll \lll \lll$	Auto search (cue)
$\lll \lll \lll \lll \lll \lll$ (Press and hold)	Manual search (fast-reverse/fast-forward)

Playing a USB memory device

Playing back music or still picture (JPEG) files recorded on a USB memory device.

Important information

- Only USB memory devices conforming to mass storage class and MTP (Media Transfer Protocol) standards can be played on this unit.
- This unit is compatible with USB memory devices in "FAT16" or "FAT32" format.
- This unit is compatible with MP3 files conforming to "MPEG-1 Audio Layer-3" standards.
- File types that this unit can play back and specifications are shown below.

[Supported file types]

Supported file types	USB memory devices *1
WMA (Windows Media Audio)	✓*2
MP3 (MPEG-1 Audio Layer-3)	✓
WAV	✓
MPEG-4 AAC	✓*3
FLAC (Free Lossless Audio Codec)	✓
JPEG	✓

*1 USB memory device

- This unit is compatible with MP3 ID3-Tag (Ver. 2) standard.
- This unit can show the artwork that was embedded by using MP3 ID3-Tag Ver. 2.3 or 2.4.
- This unit is compatible with WMA META tags.
- If the image size (pixels) of an album artwork exceeds 500 × 500 (WMA/MP3/WAV/FLAC) or 349 × 349 (MPEG-4 AAC), then music may not be played back properly.
- WAV format Quantization bit length: 16 bits.
- FLAC format Quantization bit length: 16 or 24 bits.

*2 Copyright-protected files can be played on certain portable players compatible with MTP.

*3 Only files that are not protected by copyright can be played on this unit.

Content downloaded from pay sites on the Internet are copyright protected. Also, files encoded in WMA format when ripped from a CD, etc. on a computer may be copyright protected, depending on the computer's settings.

NOTE

File types that this unit does not support are not displayed.

[Compatible formats]

	Sampling frequency	Bit rate	Extension
WMA (Windows Media Audio)	32/44.1/48 kHz	48 – 192 kbps	.wma
MP3 (MPEG-1 Audio Layer-3)	32/44.1/48 kHz	32 – 320 kbps	.mp3
WAV	32/44.1/48 kHz	–	.wav
MPEG-4 AAC	32/44.1/48 kHz	16 – 320 kbps	.aac/ .m4a/ .mp4
FLAC (Free Lossless Audio Codec)	32/44.1/48/88.2/96 kHz	–	.flac

Maximum Number of Playable Files and Folder

The limits on the number of folders and files that can be displayed by this unit are as follows.

Item	Media	USB memory devices
Memory capacity		FAT16 : 2 GB, FAT32 : 2 TB
Number of folder directory levels *1		8 levels
Number of folders		500
Number of files *2		5000

*1 The limited number includes the root folder.

*2 The allowable number of files may differ according to the USB memory device capacity and the file size.

Playing files stored on USB memory devices

1 Connect the USB memory device to the iPod/USB port (☞ [page 20](#)).

2 Press **iPod/USB** to switch the input source to “iPod/USB”.



3 Use Δ / ∇ to select the search item or folder, then press **ENTER** or \triangleright .

4 Use Δ / ∇ to select the file, then press **ENTER**, \triangleright or \blacktriangleright . Playback starts.

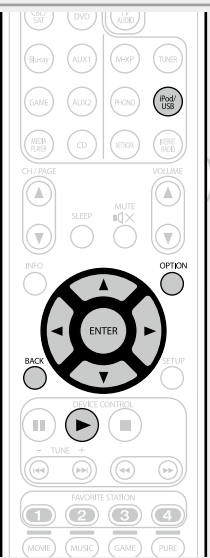

❑ Adjusting the sound quality (M-DAX)

Make this setting at “M-DAX” (☞ [page 115](#)) in the menu.

You can use the “M-DAX” function to restore to a state close to the audio before compression while correcting the bass feel to enjoy a richer playback experience. The default setting is “Off”.

❑ Going back to the previous screen

Press \triangleleft or **BACK**.

❑ Changing the screen display duration

Make this setting at “Audio Display” (☞ [page 124](#)) in the menu. The default setting is “30s”.

Press Δ / ∇ / \triangleleft \triangleright while the display is off to return to the original screen.



- When an MP3 music file includes album art data, the album art can be displayed while playing the file.
- If the USB memory device is divided into multiple partitions, only the first partition is played back.

NOTE

- Note that marantz will accept no responsibility whatsoever for any problems arising with the data on a USB memory device when using this unit in conjunction with the USB memory device.
- USB memory devices will not work via a USB hub.
- marantz does not guarantee that all USB memory devices will operate or be supplied power. When using a USB portable hard disk that can draw power from an AC adapter, we recommend using the AC adapter.
- It is not possible to connect and use a computer via the iPod/USB port of this unit using a USB cable.

Operations available through the OPTION button

Press the **OPTION** button to display a menu of functions that can be used on the TV screen. Select the function you want to use from this menu. You can easily find and use the desired function.

❑ **Searching content with keywords (Text Search)** (☞ [page 69](#))

❑ **Performing repeat playback (Repeat)** (☞ [page 70](#))

❑ **Performing random playback (Random)** (☞ [page 70](#))

❑ **Playing back music and a favorite picture at the same time (Picture View)** (☞ [page 72](#))

❑ **Playing back still images in sequential order (Slideshow)** (☞ [page 72](#))

□ USB memory device operation buttons

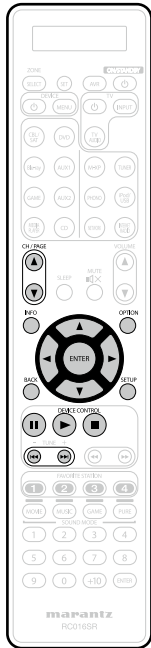

Operation buttons	Function
CH/PAGE ▲▼	Page search
INFO	Display of information such as the source name, volume, and sound mode name
OPTION	Text Search / Repeat playback / Random playback / Picture View / Slideshow
△▽◀▶	Cursor operation / Auto search (cue, △▽)
ENTER (Press and release)	Enter
ENTER (Press and hold)	Stop
BACK	Return
SETUP	Setup
II	Pause
▶	Playback / Pause
■	Stop
◀◀ ▶▶	Auto search (cue)

Listening to HD Radio stations

For antenna connections, see “Connecting an HD Radio receiver” ([page 23](#)).

Important information

□ Using the HD Radio™ receiver

HD Radio stations offer higher sound quality than conventional FM/ AM broadcasts. It is also possible to receive data services and select broadcasts from among up to eight multicast programs.

HD Radio Technology provides higher quality sound than conventional broadcasts and allows reception of data services.

Digital Sound

- Digital, CD-quality sound. HD Radio Technology enables local radio stations to broadcast a clean digital signal. AM sounds like today’s FM and FM sounds like a CD.

PSD

- Program Service Data: Contributes to the superior user experience of HD Radio Technology. Presents song name, artist, station IDs, and other relevant data streams.

HD2/HD3

- Adjacent to traditional main stations are extra local FM channels. These HD2/HD3 Channels provide new, original music as well as deep cuts into traditional genre.



HD Radio Technology manufactured under license from iBiquity Digital Corporation. U.S. and Foreign Patents. HD Radio™ and the HD, HD Radio, and “Arc” logos are proprietary trademarks of iBiquity Digital Corp.

For detailed information on HD Radio Technology, please go to “www.hdradio.com/”.

How to tune in

The modes for receiving FM broadcasts consists of “Auto” mode that automatically searches available broadcast stations and “Manual” mode that lets you tune in using buttons to change the frequency. The default setting is “Auto”. You can also use “Direct Tune” to tune in by entering the frequency directly. In “Auto” mode, you cannot tune in to radio stations if the reception is not good. If this is the case, then use the “Manual” mode or “Direct Tune” to tune in.

Listening to HD Radio stations

- 1 Press **TUNER** to switch the input source to “HD Radio”.

[TV Screen]

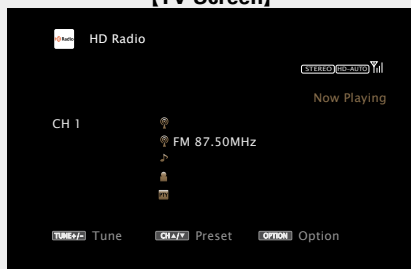

[Display of this unit]

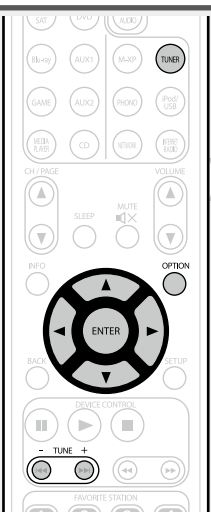
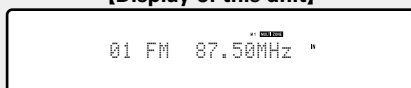

- 2 Press **OPTION**.
The option menu screen is displayed.

- 3 Use Δ / ∇ to select “Band”, then press **ENTER**.
The Band screen is displayed.

[TV Screen]



[Display of this unit]

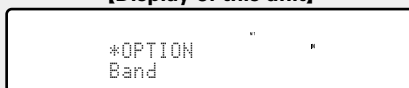

- 4 Use \triangleleft / \triangleright to select “FM” or “AM”, then press **ENTER**.

[TV Screen]



[Display of this unit]



FM When listening to an FM broadcast.

AM When listening to an AM broadcast.

- 5 Press **TUNE +** or **TUNE -** to select the station you want to hear.

Scanning is performed until it finds an available radio station. When it finds a radio station, it stops the scan automatically and tunes in.



- If the desired station cannot be tuned in with auto tuning, tune it in manually.
- When tuning in stations manually, press and hold **TUNE +** or **TUNE -** to change frequencies continuously.

Changing the screen display duration

Make this setting at “Audio Display” ([page 124](#)) in the menu. The default setting is “30s”.

Press Δ / ∇ / \triangleleft / \triangleright while the display is off to return to the original screen.

Adding to the FAVORITE STATION button

([page 71](#))

Operations available through the OPTION button

Press the **OPTION** button to display a menu of functions that can be used on the TV screen. Select the function you want to use from this menu. You can easily find and use the desired function.

Tuning in by entering the radio frequency (Direct Tune) ([page 48](#))

Presetting the current broadcast station (Preset Memory) ([page 50](#))

Changing the tuning mode (Tune Mode) ([page 47](#))

Tuning in to radio stations and presetting them automatically (Auto Preset Memory) ([page 49](#))

Specify a name for the preset broadcast station (Preset Name) ([page 51](#))

Skipping preset broadcast stations (Preset Skip) ([page 52](#))

Changing the tuning mode (Tune Mode)

You can change the mode for tuning into FM/AM broadcasts.

1 Press **TUNER** to switch the input source to “HD Radio”.

2 Press **OPTION**.
The option menu screen is displayed.

3 Use $\Delta \nabla$ to select “Tune Mode”, then press **ENTER**.

[TV Screen]



[Display of this unit]

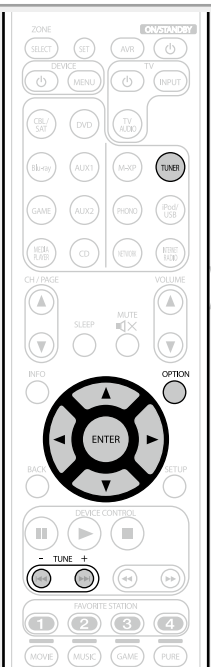
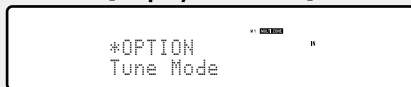

4 Use $\triangleleft \triangleright$ to select tuning mode, then press **ENTER**.

[TV Screen]

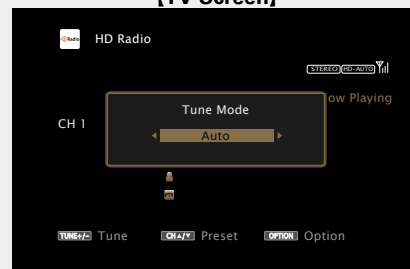

[Display of this unit]

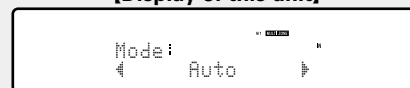

- Auto** Automatically tune to the station.
- HD-Auto** Automatically tune to the HD Radio station.
- Analog-Auto** Automatically tune to an analog station and analog HD Radio station.
- Manual** Manually tune to the station.
- Analog-Manual** Manually tune to an analog station and analog HD Radio station.



When tuning in stations manually, press and hold **TUNE +** or **TUNE -** to change frequencies continuously.

Selecting audio programs

HD Radio Technology enables stations to broadcast multiple Audio Program and data services on HD2 / HD3 / HD4 channels.

1 Select the tuning mode (“HD-AUTO”, “AUTO” or “MANUAL”).

2 Press **TUNE +** or **TUNE -** to tune in the desired Multicast channel.

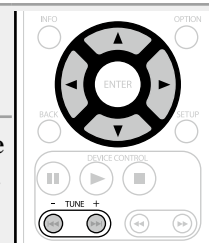

- If the station you are tuning in has multiple audio programs, “HD1” is indicated on the display.
- If it only has one audio program, “HD” is indicated.
- When the unit receives multicast channels, the multicast program number (HD2) is displayed to the right of the station name.

NOTE

- This function is not available for AM HD Radio stations because they cannot broadcast multicast channels.
- If digital audio data cannot be received after the station is selected, or if the station signal is weak, the unit may not be able to receive the multicast channels.
- If the station signal is weak, the digital audio of the multicast channel may cut out.

Changing the screen display duration

Make this setting at “Audio Display” ([page 124](#)) in the menu. The default setting is “30s”.

Press $\Delta \nabla \triangleleft \triangleright$ while the display is off to return to the original screen.

□ Tuning in by entering the radio frequency (Direct Tune)

You can enter the receiving frequency directly to tune in.

1 Press TUNER to switch the input source to “HD Radio”.

2 Press OPTION.
The option menu screen is displayed.

3 Use Δ / ∇ to select “Direct Tune”, then press ENTER.
The direct tuner screen is displayed and “-” in the display flashes.

[TV Screen]



[Display of this unit]

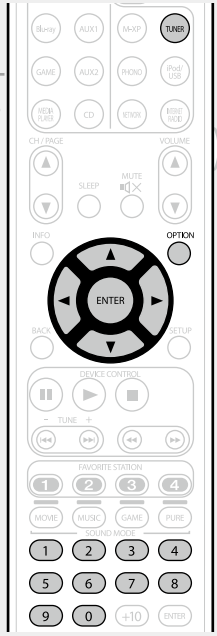
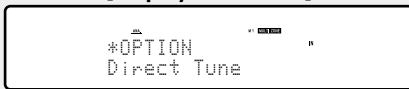

4 Use Δ / ∇ or 0 – 9 to select a number and press \triangleright .
The screen that lets you enter the frequency is displayed.

[TV Screen]



[Display of this unit]



• If \triangleleft is pressed, the immediately preceding input is cancelled.

5 Repeat step 4 and enter the frequency of the radio station you want to hear.

6 When setting is completed, press ENTER.
The preset frequency is tuned in.

Presetting broadcast stations

□ Tuning in to radio stations and presetting them automatically (Auto Preset Memory)

Up to 56 stations can be preset.

If "Auto Preset Memory" is performed after performing "Preset Memory", the "Preset Memory" settings will be overwritten.

1 Press **TUNER** to switch the input source to "HD Radio".

2 Press **OPTION**.
The option menu screen is displayed.

3 Use Δ / ∇ to select "Auto Preset Memory", then press **ENTER**.

[TV Screen]

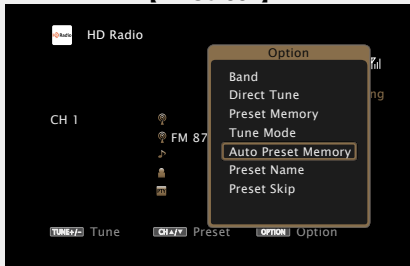

[Display of this unit]

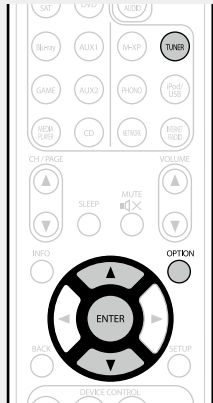
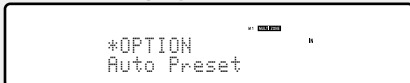

4 Press **ENTER**.
The unit starts to tune in to radio stations automatically and preset them.

[TV Screen]



[Display of this unit]

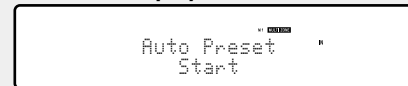

- When presetting is completed, "Completed" is displayed for about 5 seconds and the option menu screen turns off.

❑ Presetting the current broadcast station (Preset Memory)

Your favorite broadcast stations can be preset so that you can tune them in easily. Up to 56 stations can be preset.

1 Tune in the broadcast station you want to preset.

2 Press **OPTION**.
The option menu screen is displayed.

3 Use $\Delta \nabla$ to select “Preset Memory”, then press **ENTER**.
The list of already preset channels is displayed.

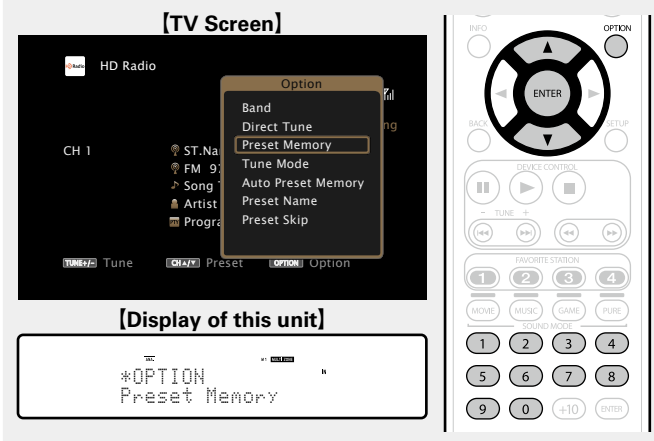

4 Use $\Delta \nabla$ or **0 – 9** to select the channel you want to preset, then press **ENTER**.

The current broadcast station that is preset.

- To preset other stations, repeat steps 1 to 4.

[TV Screen]

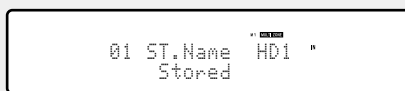
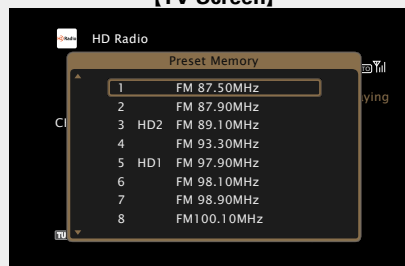

The channel numbers of broadcast stations set as “Preset Skip” (see page 52) are grayed out, but these stations can be preset. When grayed out channel numbers are preset, these are highlighted and the “Preset Skip” setting changes to “On”.

Channel	Default Settings
1 – 8	87.50 / 87.90 / 89.10 / 93.30 / 97.90 / 98.10 / 98.90 / 100.10 MHz
9 – 16	101.90 / 102.70 / 107.90 / 90.10 / 90.10 / 90.10 / 90.10 / 90.10 MHz
17 – 24	530 / 600 / 930 / 1000 / 1120 / 1210 / 1400 / 1710 kHz
25 – 32	90.10 / 90.10 / 90.10 / 90.10 / 90.10 / 90.10 / 90.10 / 90.10 MHz
33 – 40	90.10 / 90.10 / 90.10 / 90.10 / 90.10 / 90.10 / 90.10 / 90.10 MHz
41 – 48	90.10 / 90.10 / 90.10 / 90.10 / 90.10 / 90.10 / 90.10 / 90.10 MHz
49 – 56	90.10 / 90.10 / 90.10 / 90.10 / 90.10 / 90.10 / 90.10 / 90.10 MHz

Listening to preset stations

Use **CH/PAGE** $\Delta \nabla$ or **0 – 9** to select the desired preset channel.

[Display of this unit]

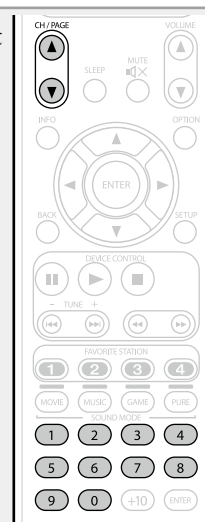
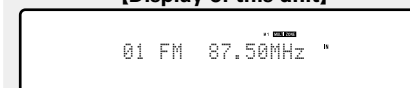

Specify a name for the preset broadcast station (Preset Name)

You can set the name to the preset broadcast station or change it. Up to eight characters can be input.

1 Press TUNER to switch the input source to "HD Radio".

2 Press OPTION.
The option menu screen is displayed.

3 Use Δ / ∇ to select "Preset Name", then press ENTER.
The Preset Name screen is displayed.

[TV Screen]



[Display of this unit]

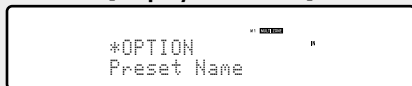

4 Use \triangleleft / \triangleright to select the group of the broadcast station you want to name then press ENTER.

The screen that lets you edit the preset name is displayed.

- Each time \triangleleft / \triangleright is pressed, the setting is changed as shown below.

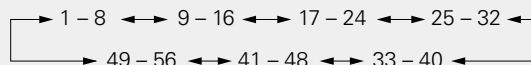

[TV Screen]

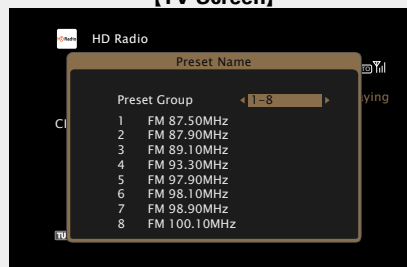

[Display of this unit]

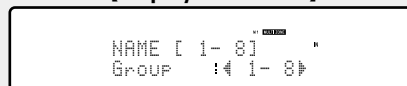

5 Use Δ / ∇ to select the broadcast station you want to name, then press ENTER.

[TV Screen]

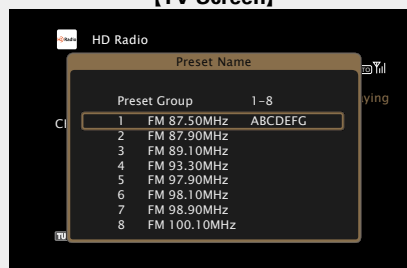

[Display of this unit]

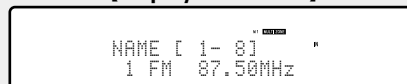

6 Use Δ / ∇ to select a name label, then press ENTER.

The screen that lets you edit the preset name is displayed.

- If you select "Set Defaults", then the unit returns to displaying the frequency.

7 Enter the characters, then press **OK.**

- For character input, see [page 111](#).

8 Press BACK twice.

The display returns to the playback screen.

❑ Skipping preset broadcast stations (Preset Skip)

You can set in advance, the stations you do not want to be displayed when tuning in, by groups or by stations. The preset skip setting is useful when tuning in, because only your favorite stations are displayed.

1 Press **TUNER** to switch the input source to "HD Radio".

2 Press **OPTION**.
The option menu screen is displayed.

3 Use $\Delta \nabla$ to select "Preset Skip", then press **ENTER**.
The Preset Skip screen is displayed.

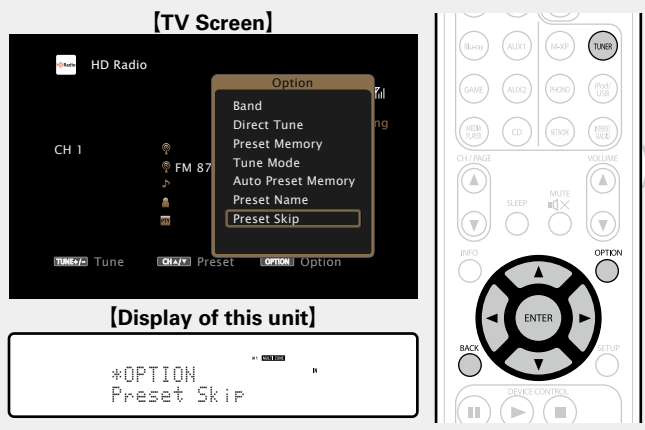

4-1 [To set the stations you want to skip by groups]

- Use $\triangleleft \triangleright$ to select the group of broadcast stations you want to skip.
 - Each time $\triangleleft \triangleright$ is pressed, the setting is changed as shown below.

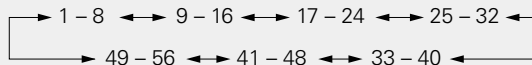

- Press Δ to select "Set * - * to Skip", then press **ENTER**.
All broadcast stations in the group "* - *" you selected are not displayed. (* are the selected group numbers)
- Press **BACK**.

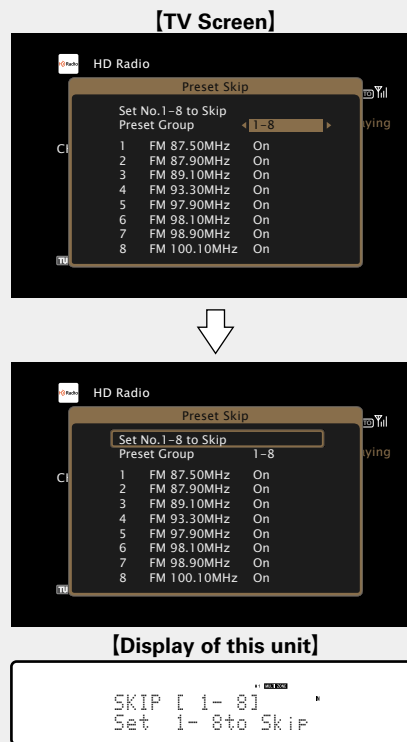

4-2 [To set the stations you want to skip by stations]

- Use $\triangleleft \triangleright$ to select the group of broadcast stations you want to skip.
 - Each time $\triangleleft \triangleright$ is pressed, the setting is changed as shown below.

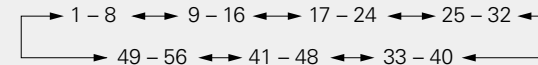

- Use $\Delta \nabla$ to select the broadcast station you want to skip.
- Use $\triangleleft \triangleright$ to select "Skip".
The station you selected is not displayed.
- Press **BACK**.

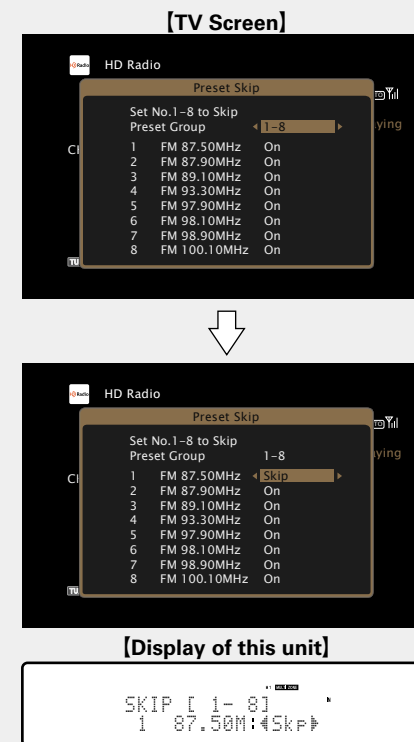

Cancelling preset skip

1 While the Preset Skip screen is displayed, use ◀▶ to select a group containing a broadcast station to cancel the skip for.

2 Use ▲▼ to select a broadcast station to cancel the skip for.

[TV Screen]



[Display of this unit]

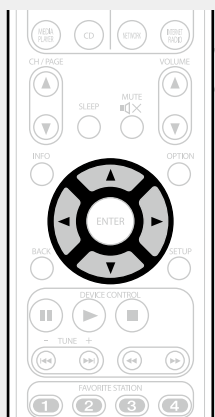
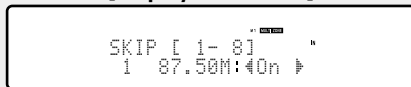

3 Use ◀▶ to select “On”.
The skip is cancelled.

NOTE

You cannot cancel the skip for each group.

Check the HD Radio reception information

Press **STATUS** on the main unit while an HD Radio broadcast is being received.

The current reception information is shown on the display.

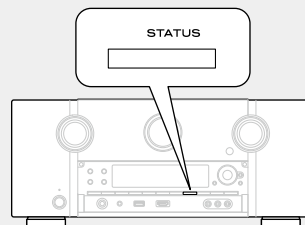

- ① Normal
- ↓
- ② Frequency / Signal strength
- ↓
- ③ Station name / Program and Program type
- ↓
- ④ Title name / Artist name
- ↓
- ⑤ Album name / Genre name

NOTE

If the station signal weakens while receiving a digital broadcast (while “HD” and text is displayed), the mode automatically switches to the analog reception mode (the reception frequency is displayed). Because of this, the “HD” and text may flicker if the station signal level is weak and unstable.

Tuner (HD Radio reception) operation buttons

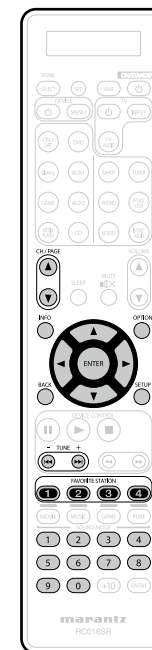

Operation buttons	Function
CH/PAGE ▲▼	Preset channel selection
INFO	Display of information such as the source name, volume, and sound mode name
OPTION	Switch tuning modes / Direct frequency tuning / Preset Memory / Auto Preset Memory / Preset Name / Preset Skip
◀▶▲▼	Cursor operation
ENTER	Enter
BACK	Return
SETUP	Setup
TUNE +, -	Tuning (up/down) Multicast switching
FAVORITE STATION 1 - 4 (Press and release)	Call up favorites
FAVORITE STATION 1 - 4 (Press and hold)	Add to the favorites list
0 - 9	Preset channel selection (1 - 8) / Direct frequency tuning (0 - 9)

Network contents

Listening to internet radio

Internet radio refers to radio broadcasts distributed over the Internet. Internet radio stations from around the world can be received.

Important information

The broadcast station types and specifications supported by this unit for playback are as follows.

[Playable broadcast station types]

Supported file types	Internet radio
WMA (Windows Media Audio)	✓
MP3 (MPEG-1 Audio Layer-3)	✓

[Playable broadcast station specifications]

	Sampling frequency	Bit rate	Extension
WMA (Windows Media Audio)	32/44.1/48 kHz	48 – 192 kbps	.wma
MP3 (MPEG-1 Audio Layer-3)	32/44.1/48 kHz	32 – 320 kbps	.mp3

Listening to internet radio

1 Prepare for playback.

- ① Check the network environment, then turn on this unit's power (see [page 27](#) "Connecting to a home network (LAN)").
- ② If settings are required, make the "Settings" (see [page 137](#)).

2 Press NETWORK.

- You can also press **INTERNET RADIO** to select the input source "Internet Radio" directly.

3 Use Δ ∇ \triangleleft \triangleright to select "Internet Radio", then press ENTER.

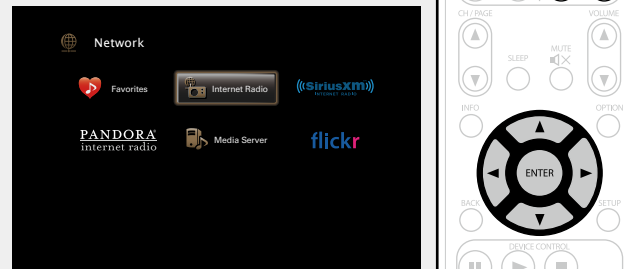

4 Use Δ ∇ to select the item you want to play, then press ENTER or \triangleright .

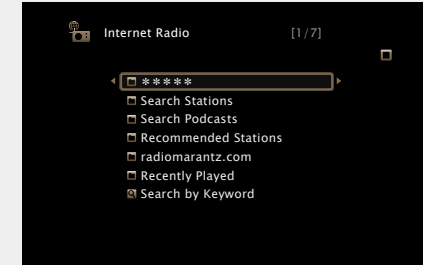

- *******
(Country name) Displays typical Internet radio stations your country.
- Search Stations** Displays all Internet radio stations that this unit can tune in to.
- Search Podcasts** Displays Internet radio stations in the podcasts that this unit can tune in to.
- Recommended Stations** Displays recommended Internet radio stations.
- radiomarantz.com** Displays Internet radio stations added to favorites in vTuner. For instructions on how to add to favorites in vTuner, see "Using vTuner to add Internet radio stations to favorites" (see [page 56](#)).
- Recently Played** Displays recently played Internet radio stations. Up to 20 stations stored in "Recently Played".
- Search by Keyword** Displays Internet radio stations searched by keyword. For character input, see [page 111](#).

5 Repeat step 4 until the station list is displayed.

The station list is displayed.

6 Use Δ ∇ to select the station, then press ENTER or \triangleright .

Playback starts once buffering reaches "100%".

❑ Adjusting the sound quality (M-DAX)

Make this setting at "M-DAX" ([page 115](#)) in the menu.

You can use the "M-DAX" function to restore to a state close to the audio before compression while correcting the bass feel to enjoy a richer playback experience. The default setting is "Off".

❑ Switching the screen display

Press **STATUS** on the main unit.

The display switches between track title and radio station name etc. each time the button is pressed.

❑ Going back to the previous screen

Press ◀ or **BACK**.

❑ Changing the screen display duration

Make this setting at "Audio Display" ([page 124](#)) in the menu. The default setting is "30s".

Press ▲▼◀▶ while the display is off to return to the original screen.



- There are many Internet radio stations on the Internet, and the quality of the programs they broadcast as well as the bit rate of the tracks varies widely. Generally, the higher the bit rate, the higher the sound quality, but depending on the communication lines and server traffic, the music or audio signals being streamed may be interrupted. Inversely, lower bit rates mean a lower sound quality but less tendency for the sound to be interrupted.
- "Radio station server full" or "Connection down" is displayed if the station is busy or not broadcasting.
- On this unit, folder and file names can be displayed as titles. Any characters that cannot be displayed are replaced with "." (period).

NOTE

The radio station database service may be suspended without notice.

Operations available through the OPTION button

Press the **OPTION** button to display a menu of functions that can be used on the TV screen. Select the function you want to use from this menu. You can easily find and use the desired function.

❑ Searching content with keywords
(Text Search) ([page 69](#))

❑ Add to favorites from the Option menu
(Favorite Memory) ([page 71](#))

❑ Playing back music and a favorite picture at the same time (Picture View) ([page 72](#))

❑ Playing the last played Internet radio station

This unit memorizes the last played Internet radio station. If you press **INTERNET RADIO** to switch to the Internet radio function from another input source, the last Internet radio station you listened to is played.

Press INTERNET RADIO.

The source switches to "Internet Radio" and the last played radio station plays.

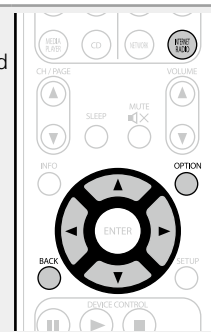

❑ Using vTuner to add Internet radio stations to favorites

There are many Internet radio stations in the world, and this unit can tune into these stations. But finding the radio station you want to hear may be difficult, because there are too many stations. If this is the case, then please use vTuner, an Internet radio station search website specifically designed for this unit. You can use your PC to search Internet radio stations and add them as your favorites. This unit can play radio stations added to vTuner.

1 Check the MAC address of this unit (☞ page 136).

The screen that lets you edit the preset name is displayed.

MAC address:

- The MAC address is necessary when you create an account for vTuner.

2 Use your PC to access the vTuner website (<http://www.radiomarantz.com>).

The vTuner login screen is displayed.

3 Enter the MAC address of this unit, then click “Go”.

The account creation screen is displayed.

4 Enter your E-mail address and a password of your choice.

The account is registered and you can now log in.

5 Enter your account information (E-mail address and password) and log in.

The top menu of vTuner is displayed.

6 Select the search criteria (genre, region, language, etc.) of your choice.

The list of radio stations matching the criteria is displayed.

- You can also enter a keyword to search for a station you want to hear.

7 Select the radio station of your choice from the list, and then click the Add to Favorites icon.

The screen that lets you create a favorite group is displayed.

8 Enter the name of the favorite group, then click “Go”.

A new favorite group that includes the selected radio station is created.

- Internet radio stations added to favorites in vTuner can be played from “radiomarantz.com” (☞ page 54) with this unit.

❑ Internet radio operation buttons



Operation buttons	Function
INTERNET RADIO	Last played internet radio station
CH/PAGE ▲▼	Page search
INFO	Display of information such as the source name, volume, and sound mode name
OPTION	Text Search / Favorite Memory / Picture View
△▽◀▶	Cursor operation
ENTER (Press and release)	Enter
ENTER (Press and hold)	Stop
BACK	Return
SETUP	Setup
■	Stop
FAVORITE STATION 1 – 4 (Press and release)	Call up favorites
FAVORITE STATION 1 – 4 (Press and hold)	Add to the favorites list

Playing back files stored on a PC and NAS

This unit can play back music files and playlists (m3u, wpl) stored on a PC and on Network Attached Storage (NAS) that supports DLNA.

Important information

- The network audio playback function of this unit connects to the server using technologies shown below.
 - Windows Media Player Network Sharing Service
 - Windows Media DRM10
- File types that this unit can play back and specifications are shown below.

[Supported file types]

Supported file types	Media server *1
WMA (Windows Media Audio)	✓
MP3 (MPEG-1 Audio Layer-3)	✓
WAV	✓
MPEG-4 AAC	✓*2
FLAC (Free Lossless Audio Codec)	✓
JPEG	✓

A server or server software compatible with distribution in the corresponding formats is required to play music files via a network.

*1 Media server

- This unit is compatible with MP3 ID3-Tag (Ver. 2) standard.
- This unit can show the artwork that was embedded by using MP3 ID3-Tag Ver. 2.3 or 2.4.
- This unit is compatible with WMA META tags.
- If the image size (pixels) of an album artwork exceeds 500 × 500 (WMA/MP3/WAV/FLAC) or 349 × 349 (MPEG-4 AAC), then music may not be played back properly.
- WAV format Quantization bit length: 16 bits.
- FLAC format Quantization bit length: 16 or 24 bits.

*2 Only files that are not protected by copyright can be played on this unit.

Content downloaded from pay sites on the Internet are copyright protected. Also, files encoded in WMA format when ripped from a CD, etc. on a computer may be copyright protected, depending on the computer's settings.

NOTE

File types that this unit does not support are not displayed.

[Specifications of supported files]

	Sampling frequency	Bit rate	Extension
WMA (Windows Media Audio)	32/44.1/48 kHz	48 – 192 kbps	.wma
MP3 (MPEG-1 Audio Layer-3)	32/44.1/48 kHz	32 – 320 kbps	.mp3
WAV	32/44.1/48 kHz	–	.wav
MPEG-4 AAC	32/44.1/48 kHz	16 – 320 kbps	.aac/ .m4a/ .mp4
FLAC (Free Lossless Audio Codec)	32/44.1/48/88.2/96 kHz	–	.flac

Applying media sharing settings

Here, we apply the settings to share music files stored on a PC and NAS on the network.

Sharing media stored in PC

If you are using a media server, be sure to apply this setting first.

When using Windows Media Player 12 (Windows 7)

NOTE

Perform this procedure after changing the control panel display to "Category".

- 1** In the PC's "Control Panel", select "Network and Internet" - "Choose homegroup and sharing options".
- 2** Select the "Stream my pictures, music, and videos to all devices on my home network" check box and select "Choose media streaming options".
- 3** Select "Allowed" in the drop-down list for "SR7007".
- 4** Select "Allowed" in the drop-down list for "Media programs on this PC and remote connections...".
- 5** Click "OK" to finish.

When using Windows Media Player 11

- 1** Start up Windows Media Player 11 on the PC.
- 2** Select "Media Sharing" in the "Library".
- 3** Click the "Share my media" check box, select "SR7007", and then click "Allow".
- 4** As you did in step 3, select the icon of the device (other PCs and mobile devices) you want to use as a media controller, and then click "Allow".
- 5** Click "OK" to finish.

Sharing media stored in NAS

Change settings on the NAS to allow this unit and other devices (PCs and mobile devices) used as media controllers to access the NAS. For details, see the owner's manual that came with the NAS.

Playing back files stored on a PC and NAS

Use this procedure to play music files, image files or playlists.

1 Prepare for playback.

- ① Check the network environment, then turn on this unit's power (☞ [page 27](#) "Connecting to a home network (LAN)").
- ② If settings are required, make the "Settings" (☞ [page 137](#)).
- ③ Prepare the computer (☞ Computer's operating instructions).

2 Press NETWORK.

3 Use $\Delta \nabla \triangleleft \triangleright$ to select "Media Server", then press ENTER.

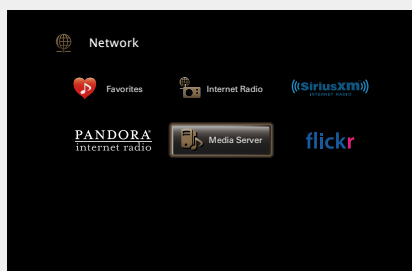

4 Use $\Delta \nabla$ to select the server including the file to be played, then press ENTER or \triangleright .

5 Use $\Delta \nabla$ to select the search item or folder, then press ENTER or \triangleright .

6 Repeat step 4 until the file is displayed.

7 Use $\Delta \nabla$ to select the file, then press ENTER or \triangleright . Playback starts once buffering reaches "100%".

☐ Adjusting the sound quality (M-DAX)

Make this setting at "M-DAX" (☞ [page 115](#)) in the menu.

You can use the "M-DAX" function to restore to a state close to the audio before compression while correcting the bass feel to enjoy a richer playback experience. The default setting is "Off".

☐ Switching the screen display

Press **STATUS** on the main unit.

The display switches between track title, artist name, and album title each time the button is pressed.

☐ Going back to the previous screen

Press \triangleleft or **BACK**.

☐ Changing the screen display duration

Make this setting at "Audio Display" (☞ [page 124](#)) in the menu. The default setting is "30s".

Press $\Delta \nabla \triangleleft \triangleright$ while the display is off to return to the original screen.



- When a WMA (Windows Media Audio), MP3 or MPEG-4 AAC file includes album art data, the album art can be displayed while the music files are playing.
- If you use Ver. 11 or later of Windows Media Player, the album art for WMA files can be displayed.
- WMA Lossless files can be played when using a server supporting transcoding, such as Windows Media Player Ver. 11 or later.

NOTE

- Depending on the size of the still picture (JPEG) file, some time may be required for the file to be displayed.
- The order in which the tracks/files are displayed depends on the server specifications. If the tracks/ files are not displayed in alphabetical order due to the server specifications, searching by the first letter may not work properly.

Operations available through the OPTION button

Press the **OPTION** button to display a menu of functions that can be used on the TV screen. Select the function you want to use from this menu. You can easily find and use the desired function.

❑ **Searching content with keywords (Text Search)** (☞ page 69)

❑ **Performing repeat playback (Repeat)** (☞ page 70)

❑ **Performing random playback (Random)** (☞ page 70)

❑ **Add to favorites from the Option menu (Favorite Memory)** (☞ page 71)

❑ **Playing back music and a favorite picture at the same time (Picture View)** (☞ page 72)

❑ **Playing back still images in sequential order (Slideshow)** (☞ page 72)

❑ Media server operation buttons

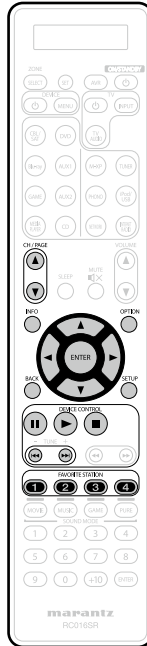

Operation buttons	Function
CH/PAGE ▲▼	Page search
INFO	Display of information such as the source name, volume, and sound mode name
OPTION	Text Search / Repeat playback / Random playback / Favorite Memory / Picture View / Slideshow
△▽◀▶	Cursor operation / Auto search (cue, △▽)
ENTER (Press and release)	Enter
ENTER (Press and hold)	Stop
BACK	Return
SETUP	Setup
II	Pause
▶	Playback / Pause
■	Stop
◀▶▶▶	Auto search (cue)
FAVORITE STATION 1 – 4 (Press and release)	Call up favorites
FAVORITE STATION 1 – 4 (Press and hold)	Add to the favorites list

Using online services

This unit supports playback of the online services shown below.

❑ About Flickr (👉 page 62)

Flickr is an online photograph sharing service that started in 2004. You can use this unit to view photographs that have been made public by Flickr users. You do not need an account to use Flickr.

To view photographs that you recorded yourself, you need an account in order to upload these photographs to the Flickr server. For details, see the Flickr homepage.

<http://www.flickr.com/>

❑ About Pandora® (👉 page 64)

Pandora is an automated music recommendation and Internet radio service created by the Music Genome Project.

To listen to Pandora you will need a free Pandora account. If you do not have a Pandora account, you can create one at www.pandora.com or from the Pandora smartphone application.

It is necessary to associate this machine with a Pandora account by visiting <http://www.pandora.com/marantz> from your PC.

❑ About SiriusXM (👉 page 67)

Enjoy anywhere access to the unparalleled content of SiriusXM.

Whether on your computer, smartphone, tablet, Lynx Portable Enjoy anywhere access to the unparalleled content of SiriusXM.

Whether on your computer, smartphone, tablet, Lynx Portable Radio, or compatible Internet-connected device, you don't need to be in your vehicle to enjoy SiriusXM.

For details, see the SiriusXM homepage.

<http://www.siriusxm.com>

Viewing photographs on the Flickr site

You can view photographs shared by particular users, or all of the photographs shared on Flickr.

Viewing photographs shared by particular users

1 Prepare for playback.

- ① Check the network environment, then turn on this unit's power (☞ [page 27](#) "Connecting to a home network (LAN)").
- ② If settings are required, make the "Settings" (☞ [page 137](#)).

2 Press NETWORK.

3 Use $\Delta \nabla \triangleleft \triangleright$ to select "Flickr", then press ENTER.

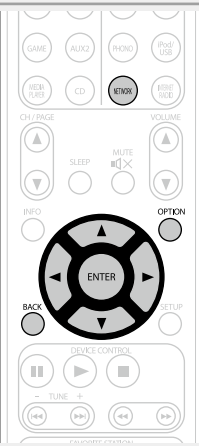
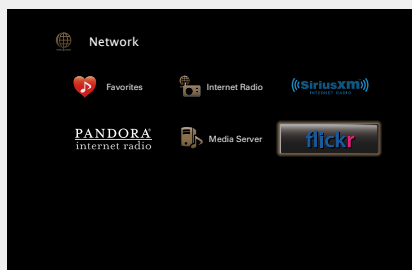

4 Use $\Delta \nabla$ to select "Add Flickr Contact", then press ENTER or \triangleright .

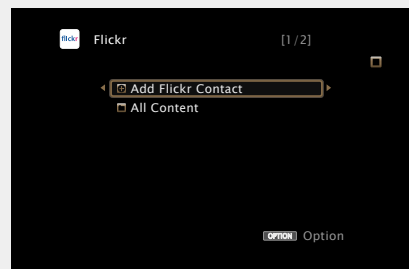

5 In "Contact", add the screen name (user name you want to view) you want to add.

- For character input, see [page 111](#).

6 After inputting the "Contact", press **OK**.

The screen name is added to "Contact", and the screen name you entered in Step 5 is displayed on the top screen of Flickr.

- If you enter a screen name that does not exist, "The Flickr Contact you entered could not be found" is displayed. Check and enter the correct screen name.

7 Use $\Delta \nabla$ to select the folder, and then press ENTER or \triangleright .

Favorites	Displays the favorite photographs of the specified user.
Photostream	Displays a list of shared photographs.
PhotoSets	Displays the folder (photograph album) list.
Contacts	Displays the screen name used by the specified user in Contacts.
Remove this Contact	Deletes a user from Flickr Contact.
Add this Contact	Adds a user from Flickr Contact.

8 Use $\Delta \nabla$ to select the file, and then press ENTER or \triangleright .

The selected file is displayed.

Going back to the previous screen

Press \triangleleft or **BACK**.

Operations available through the OPTION button

Press the **OPTION** button to display a menu of functions that can be used on the TV screen. Select the function you want to use from this menu. You can easily find and use the desired function.

- ☐ **Playing back still images in sequential order (Slideshow)** (☞ [page 72](#))

❑ Viewing all photographs on Flickr

1 Use \triangle / ∇ to select “All Content”, then press **ENTER** or \triangleright .



2 Use \triangle / ∇ to select the folder, and then press **ENTER** or \triangleright .

Interestingness Displays photographs that are popular from the number of user comments or number of times they are added as favorites.

Recent Displays the most recently added photographs.

Search by text Search for photographs by keyword.

3 Use \triangle / ∇ to select the file, and then press **ENTER** or \triangleright .
The selected file is displayed.

NOTE

Depending on the file format, some photographs cannot be viewed.

❑ Flickr operation buttons

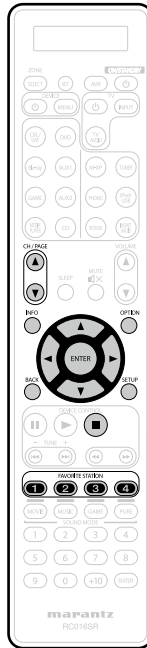

Operation buttons	Function
CH/PAGE \blacktriangle / \blacktriangledown	Page search
INFO	Display of information such as the source name, volume, and sound mode name
OPTION	Slideshow
\triangle / ∇ / \triangleleft / \triangleright	Cursor operation / Auto search (cue, \triangle / ∇)
ENTER (Press and release)	Enter
ENTER (Press and hold)	Stop
BACK	Return
SETUP	Setup
\blacksquare	Stop
FAVORITE STATION 1 – 4 (Press and release)	Call up favorites
FAVORITE STATION 1 – 4 (Press and hold)	Add to the favorites list

Listening to Pandora®

1 Prepare for playback.

- ① Check the network environment, then turn on this unit's power (see [page 27](#) "Connecting to a home network (LAN)").
- ② If settings are required, make the "Settings" (see [page 137](#)).
- ③ Complete step 4 and obtain a Pandora account.
 - If you already have a Pandora account, you do not need to obtain a new account. Use your existing Pandora account.

2 Press NETWORK.

3 Use $\Delta \nabla \triangleleft \triangleright$ to select "Pandora", then press ENTER.

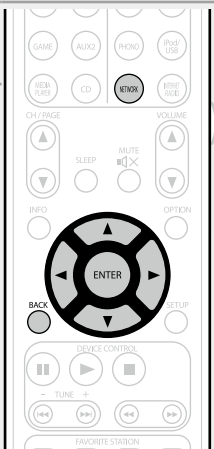
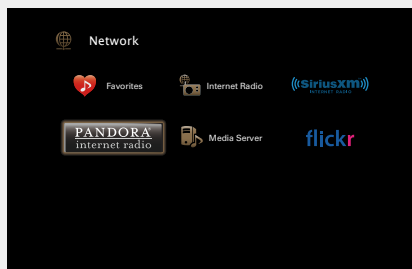

4 If you have a Pandora account, use $\Delta \nabla$ to select "I have a Pandora account", then press ENTER or \triangleright .

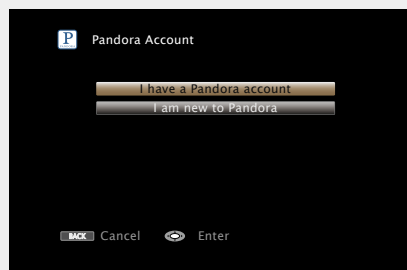

- If you do not have a Pandora account, press ∇ to select "I am new to Pandora". The URL of Pandora and activation code are displayed. Access the Pandora web page from your PC and register the displayed activation code and account information. Then press ENTER.

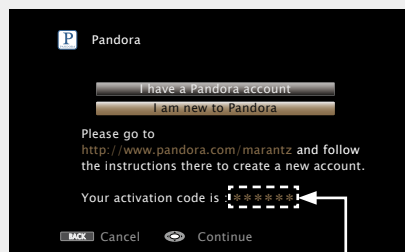

This is an identification code required to register your purchased product to the Pandora service.
This code is used to obtain your account.

5 Input "Email address" and "Password".

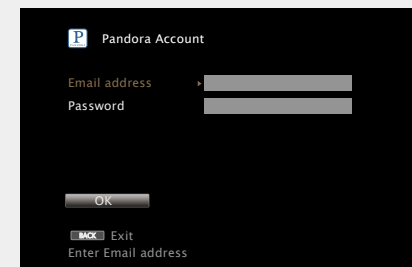

- For character input, see [page 111](#).

6 After inputting the "Email address" and "Password", select "OK", then press ENTER.

If the "Email address" and "Password" match, the top menu for Pandora is displayed.

NOTE

Press **BACK** to cancel the input. When "Cancel input?" is displayed, select "Yes", then press **ENTER**.

❑ Creating a new station

You can create up to 100 radio stations.

- 1** Use Δ / ∇ to select “New Station”, then press **ENTER** or \triangleright .

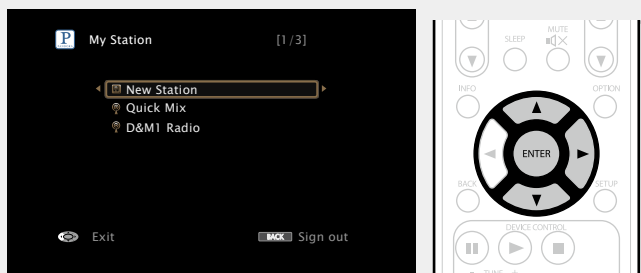

- 2** Input a track or artist name, then press **OK**.

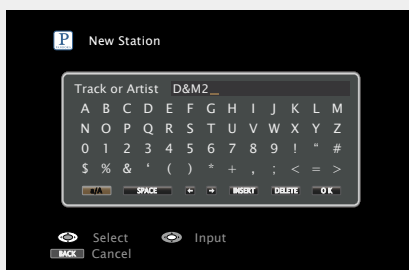

- For character input, see [page 111](#).

- 3** Use Δ / ∇ to select “Search by Artist” or “Search by Track”, then press **ENTER**.

You can search and display a list by track or artist.

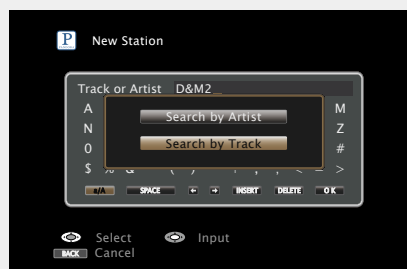

- 4** Press Δ / ∇ , select a file (e.g. D&M2) from the list, and press **ENTER** or \triangleright .

“Radio” is added to the end of a filename, and your new station is created (e.g. D&M2 Radio).



- Your new station will play music with similar qualities to the artist or track you entered.

❑ Listening to an existing station

Use Δ / ∇ and select the radio station (“D&M2 Radio”) that you want to listen to, and press **ENTER** or \triangleright .

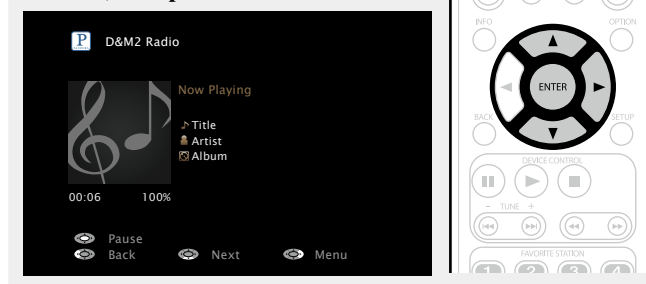

Listening to created radio stations at random

Use Δ / ∇ to select “Quick Mix”, then press **ENTER** or \triangleright .

Created radio stations are selected at random, and tracks are streamed.

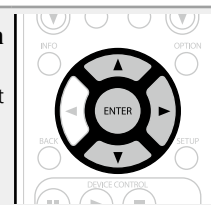

□ Giving Feedback and Managing Stations

You can personalize your stations by providing feedback.

Press **▷** while a track is playing.
The Pandora menu screen is displayed.

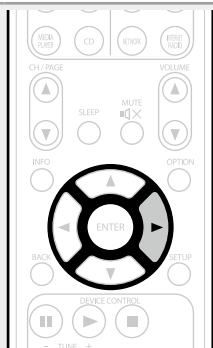
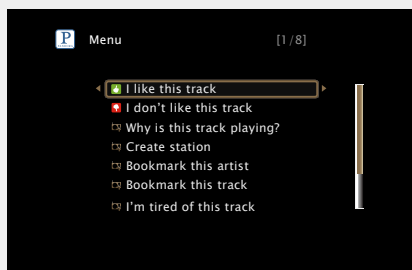

I like this track

- Press when you like the track that is being played.
- It will return to the Play Screen. And (Thumbs up) icon is displayed. (The icon is not displayed on the next track.)

I don't like this track

- Press when you don't like the track that is being played.
- It will return to the Play Screen. And (Thumbs down) icon is displayed. (The icon is not displayed on the next track.)

Why is this track playing?

- Displays the reason why Pandora selected this track.

Create station

- Creates a Station for the Track or Artist being played.

Bookmark this artist

- Bookmarks the artist currently being played.
- You can check on a computer or iPhone etc.
- For details, see the Pandora web page.

Bookmark this track

- Bookmarks the track currently being played.
- You can check on a computer or iPhone etc.
- For details, see the Pandora web page.

I'm tired of this track

- Press when you don't like the track that is being played.
- The track will not be played for 1 month.

Delete this station

- Press when you want to delete the station that is being played.

NOTE

- You can Skip up to 6 Tracks that are being played back within 1 hour.
- You can create up to 100 Stations (radio stations).

□ Sign out

Disassociate this unit from your Pandora account.

1 While the Pandora top menu is displayed, press **BACK**.

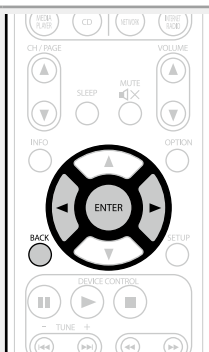
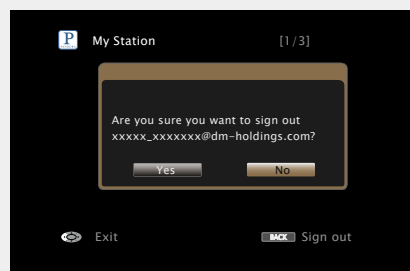

2 When the popup menu appears, use **◀ ▶** to select "Yes", then press **ENTER**.

□ Pandora operation buttons

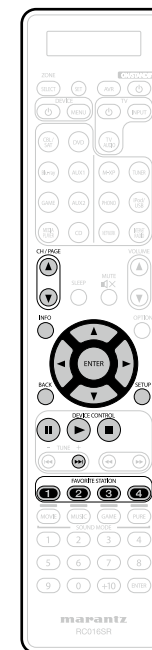

Operation buttons	Function
CH/PAGE ▲▼	Page search
INFO	Display of information such as the source name, volume, and sound mode name
△▽◀▶	Cursor operation / Auto search (cue, ▽)
ENTER (Press and release)	Enter
ENTER (Press and hold)	Stop
BACK	Return
SETUP	Setup
⏸	Pause
▶	Playback
■	Stop
▶▶	Skips the current track, subject to skip limit
FAVORITE STATION 1 – 4 (Press and release)	Call up favorites
FAVORITE STATION 1 – 4 (Press and hold)	Add to the favorites list

Listening to SiriusXM Internet Radio

Over 120 channels of the SiriusXM programming you love, including commercial-free music plus sports, talk, news and entertainment. Listen anywhere on your computer or smartphone.

1 Prepare for playback.

- ① Check the network environment, then turn on this unit's power (see [page 27](#) "Connecting to a home network (LAN)").
- ② If settings are required, make the "Settings" (see [page 137](#)).
- ③ Access the following website from your PC and obtain a SiriusXM account.
<http://www.siriusxm.com>
 - If you already have a SiriusXM account, you do not need to obtain a new account. Select "Sign in" in step 4, and enter your existing SiriusXM account.

2 Press NETWORK.

3 Use Δ ∇ \triangleleft \triangleright to select "SiriusXM", then press ENTER.

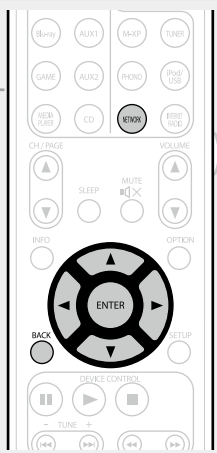
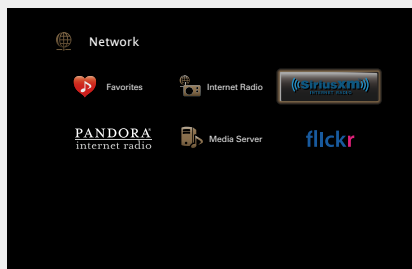

4 Select "Sign in", then press ENTER.

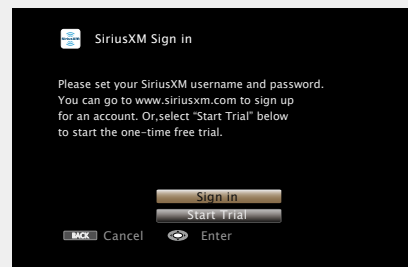

5 Input the "Username" and "Password".

- For character input, see [page 111](#).

6 Select the "Sign in", and then press ENTER.

The top menu of SiriusXM is displayed.



7 Use Δ ∇ to select the genre, then press ENTER or \triangleright .

8 Use Δ ∇ to select the file, and then press ENTER or \triangleright .

The selected file is displayed.

Going back to the previous screen

Press \triangleleft or BACK.

❑ Sign out

Disassociate this unit from your SiriusXM account.

1 While the SiriusXM top menu is displayed, press **BACK**.

2 When the popup menu appears, use **◀ ▶** to select “Yes”, then press **ENTER**.



❑ SiriusXM operation buttons

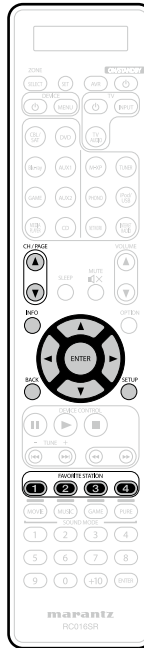

Operation buttons	Function
CH/PAGE ▲▼	Page search
INFO	Display of information such as the source name, volume, and sound mode name
◀▼▶▶	Cursor operation
ENTER (Press and release)	Enter
ENTER (Press and hold)	Stop
BACK	Return
SETUP	Setup
FAVORITE STATION 1 – 4 (Press and release)	Call up favorites
FAVORITE STATION 1 – 4 (Press and hold)	Add to the favorites list

Convenient functions

Here, we explain how to use convenient functions for NETWORK sources and USB sources. The source names under the titles of each function's description are sources that allow use of these functions.

❑ **Searching content with keywords (Text Search)** (👉 [page 69](#))

❑ **Performing repeat playback (Repeat)** (👉 [page 70](#))

❑ **Performing random playback (Random)** (👉 [page 70](#))

❑ **Favorites function** (👉 [page 71](#))

❑ **Playing back music and a favorite picture at the same time (Picture View)** (👉 [page 72](#))

❑ **Playing back still images in sequential order (Slideshow)** (👉 [page 72](#))

Searching content with keywords (Text Search)

USB | Internet Radio | Media Server

1 While content is playing, press **OPTION**.
The option menu screen is displayed.

2 Use Δ / ∇ to select "Text Search", then press **ENTER**.
The keyboard input screen is displayed.

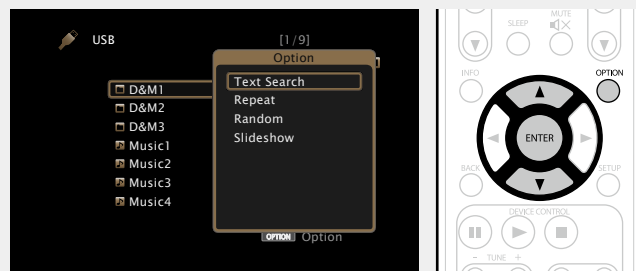

3 Enter the first character of the Internet radio station or file you want to search for, and then press **OK**.

• For character input, see [page 111](#).



"Text Search" searches for Internet radio stations or files that start with the entered first character from the displayed list.

NOTE

"Text Search" may not work for some lists.

❑ Playing back a search result content

Use Δ / ∇ to select the content you want to play, and then press **ENTER** or \triangleright .
Playback starts.

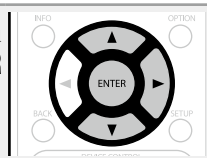

Performing repeat playback (Repeat)

USB Media Server

1 While content is playing, press **OPTION**.
The option menu screen is displayed.

2 Use Δ / ∇ to select "Repeat", then press **ENTER**.

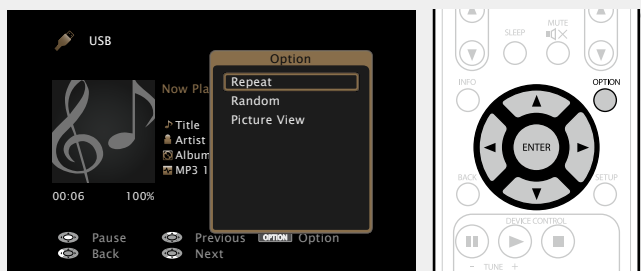

3 Use \triangleleft / \triangleright to select repeat playback mode.

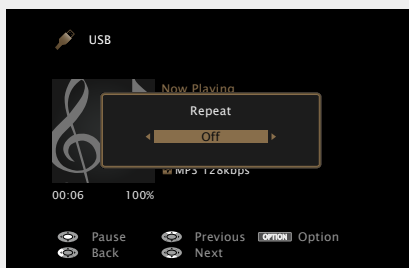

• Each time \triangleleft / \triangleright is pressed, the setting is changed as shown below.

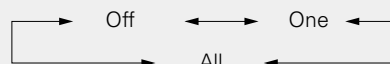

Off Repeat playback mode is canceled.

One A file being played is played repeatedly.

All All files in the folder currently being played are played repeatedly.

4 Press **ENTER**.
The display returns to the playback screen.

Performing random playback (Random)

USB Media Server

1 While content is playing, press **OPTION**.
The option menu screen is displayed.

2 Use Δ / ∇ to select "Random", then press **ENTER**.

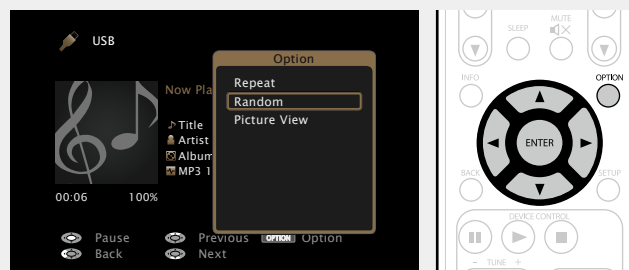

3 Use \triangleleft / \triangleright to select random playback mode.

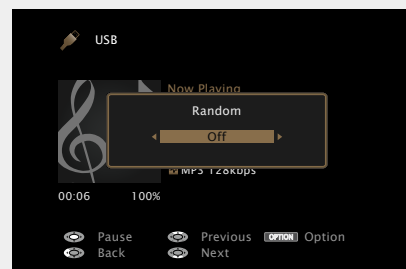

• Each time \triangleleft / \triangleright is pressed, the setting is changed as shown below.

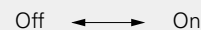

Off Disable random playback.

On Enable random playback.

4 Press **ENTER**.
The display returns to the playback screen.



The random playback randomly selects a track to play back from all tracks every time a track ends. Therefore, the same track may be played back consecutively.

Favorites function

There are two ways to add content to favorites:

- ① Add to favorites from the Option menu
- ② Add to the **FAVORITE STATION** button

❑ Add to favorites from the Option menu (Favorite Memory)

Internet Radio **Media Server**

You can add up to 100 items as favorites for all sources (Internet Radio and Media Server).

1 While content is playing, press **OPTION**.

The option menu screen is displayed.

2 Use $\Delta \nabla$ to select “Favorite Memory”, then press **ENTER**.

“Favorite added” is displayed, and the current content is added to favorites.

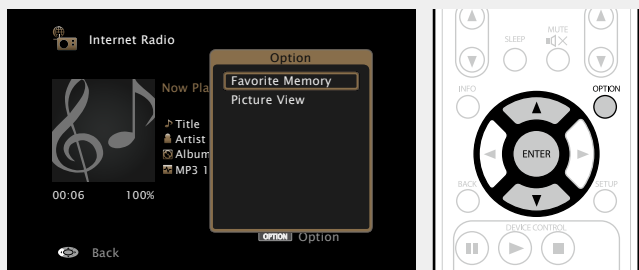

- The display returns to the playback screen when the procedure is completed.

Playing back content added in “Favorite Memory”

1 Press **NETWORK**.

2 Use $\Delta \nabla \triangleleft \triangleright$ to select “Favorites”, then press **ENTER**.

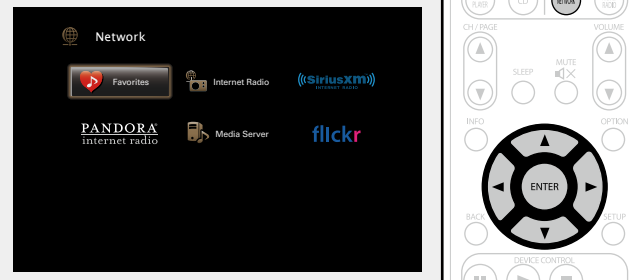

3 Use $\Delta \nabla$ to select the content you want to play, and then press **ENTER** or \triangleright . Playback starts.

❑ Adding to the **FAVORITE STATION** button

You can add up to four types of content.

NOTE

- Please note that if you add new content to a number that already contains content, the older content is deleted.
- The following operations update the database on the media server, which may make the added music files unplayable.
 - When you quit the media server and then restart it.
 - When music files are deleted or added on the media server.
- When using an ESCIENT server, place “ESCIENT” before the server name.

While content is playing, press and hold one of the **FAVORITE STATION 1 – 4** buttons for more than 3 seconds.

The content is added to the button you pressed.



Contents that can be added to the **FAVORITE STATION** button differ depending on the input source.

Input source	Contents that can be added
HD Radio	Input source / Radio station
Internet Radio	Input source / Internet Radio station
Media Server	Input source / Track
Flickr	Input source
Pandora	Input source
SiriusXM	Input source
Favorites	Input source

Playing back content added to the **FAVORITE STATION** button

You can easily call up content by pressing the **FAVORITE STATION** button.

Press one of the **FAVORITE STATION 1 – 4** buttons that you added content to. Playback starts.



When the **FAVORITE STATION 1 – 4** buttons is pressed, the AVR-operation mode starts automatically.

Deleting content added to favorites (Remove Favorites)

1 Press **NETWORK**.

2 Use $\Delta \nabla \triangleleft \triangleright$ to select "Favorites", then press **ENTER**.

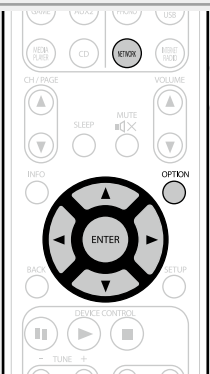
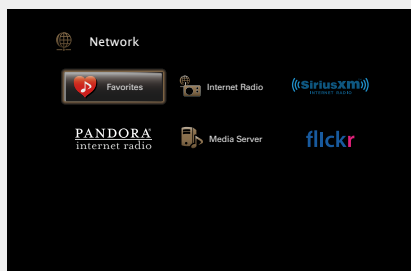

3 Use $\Delta \nabla$ to select the content you want to delete from favorites, then press **OPTION**.
The option menu screen is displayed.

4 Use $\Delta \nabla$ to select "Remove Favorites", then press **ENTER**.
"Favorite removed" is displayed, and the selected content is deleted from favorites.



• The display returns to the original screen when the procedure is completed.

Playing back music and a favorite picture at the same time (Picture View)

USB **Internet Radio** **Media Server**

1 Play back a still picture (☞ [page 62](#)).

2 Play back a music file or Internet radio station (☞ [page 54, 59](#)).

3 Press **OPTION**.
The option menu screen is displayed.

4 Use $\Delta \nabla$ to select "Picture View", then press **ENTER**.
The option menu disappears, and the picture you were viewing is shown on the screen.

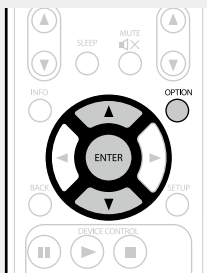
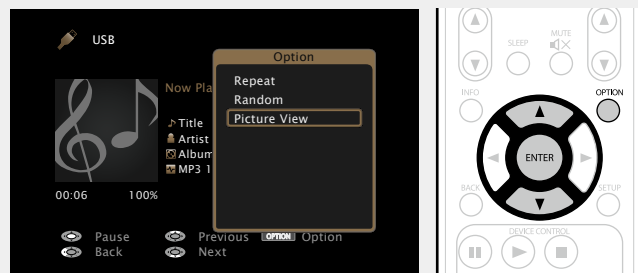

Playing back still images in sequential order (Slideshow)

You can play back still image (JPEG) files stored on a USB memory device or media server and pictures on Flickr website as a slide show. The display time can also be set.

USB **Media Server** **Flickr**

1 Play back an image and press **OPTION**.
The option menu screen is displayed.

2 Use $\Delta \nabla$ to select "Slideshow", then press **ENTER**.

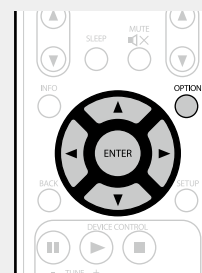
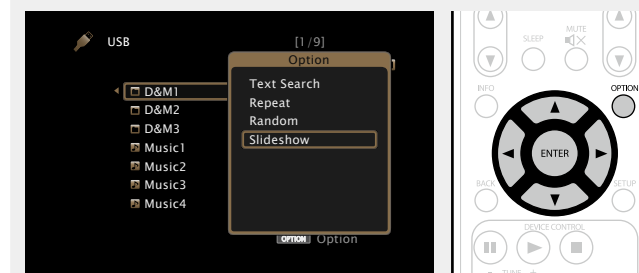

3 Use $\triangleleft \triangleright$ to set the display time.

• Each time $\triangleleft \triangleright$ is pressed, the setting is changed as shown below.

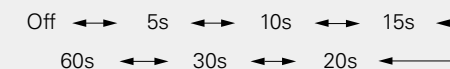

- Off** The slide show is not played back.
- 5s – 60s** Set the time for displaying a single image when playing back images in the slide show.

4 Press **ENTER**.
The slide show is displayed on the screen.

This unit plays back image (JPEG) files in the orientation in which they are stored in the folder.

AirPlay function

Enjoy music from your iTunes library with high quality sound anywhere in your home.

Use the Apple Remote app* for iPhone, iPod touch and iPad to control iTunes from any room in your home.

* Available as a free download from the App Store.

Streaming music stored in iPhone, iPod touch, or iPad directly to the unit

If you update your "iPhone/iPod touch/iPad" to iOS 4.2.1 or later, you can stream music stored in your "iPhone/iPod touch/iPad" directly to this unit.

1 Make the Wi-Fi settings for iPhone, iPod touch, or iPad.

• For details, see your device's manual.

2 Startup iPhone, iPod touch, or iPad music or iPod app.

 is displayed on the iPhone, iPod touch or iPad screen.

3 Tap the AirPlay icon .

4 Select the speaker you want to use.

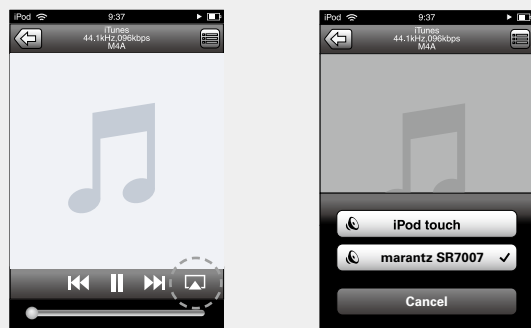

NOTE

In playback using the AirPlay function, the sound is output at the iPhone, iPod touch, iPad or iTunes volume setting level.

You should turn down the iPhone, iPod touch, iPad or iTunes volume prior to playback and then adjust it to a suitable level.

Playing iTunes music with this unit

1 Install iTunes 10, or later, on a Mac or Windows PC that is connected to the same network as this unit.

2 Turn this unit ON.

Set "IP Control" ([see page 136](#)) to "Always On" for this unit.

NOTE

When "IP Control" is set to "Always On", the unit consumes more standby power.

3 Launch iTunes and click the AirPlay icon displayed in the lower right of the window and select this unit from the list.



4 Choose a song and click play in iTunes.

The music will stream to this unit.

Selecting multiple speakers (devices)

It is possible to play iTunes songs on your home's AirPlay compatible speakers (devices) other than those of this unit.

1 Click the AirPlay icon and select "Multiple Speakers" from the list.

2 Check the speakers you want to use.

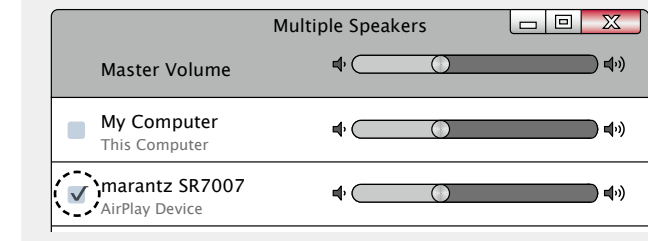

❑ Perform iTunes playback operations with the remote control unit of this unit

With this unit's remote control unit, you can perform iTunes song play, pause, and auto search (cue) operations.

1 Select "Edit" – "Preferences..." on the menu.

2 Select "Devices" in the iTunes setting window.

3 Check "Allow iTunes control from remote speakers", and then click "OK".

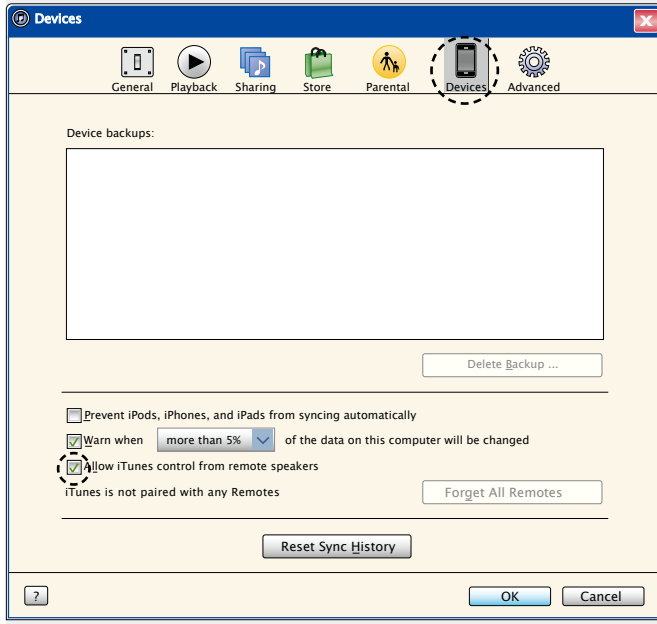

•  is displayed on the menu screen while AirPlay is being operated.

• Source input will be switched to "NETWORK" when AirPlay playback is started.

• You can stop AirPlay playback by pressing the ◀ or choosing other input source.

• To see song and artist names together, press **STATUS** on the main unit.

• For information about how to use iTunes, also see the Help for iTunes.

• The screen may differ depending on the OS and software versions.

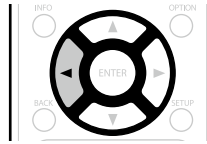

Selecting a listening mode (Sound Mode)

This unit allows you to enjoy various kinds of surround and stereo playbacks.

Multi-channel audio formats are adopted by many of the contents including Blu-ray disc and DVD as well as digital broadcasting and Internet-delivered movies and music.

This unit supports playback of almost all of these multi-channel audio formats. It also supports surround playback of audio formats other than multi-channel audio such as 2-channel stereo audio.

This unit automatically generates a list of all the playable sound modes based on the input audio format and the current speaker setup configuration and displays the list on the screen. Therefore, you can select a correct surround playback mode even if you are not familiar with sound mode selection. Try out various surround playback modes and enjoy surround playback in your favorite mode.

[Example] When **MOVIE** is pressed and held

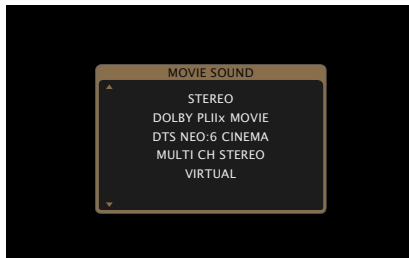

The displayed sound modes include the 2-channel stereo playback mode.



For audio formats recorded in a disc, see the disc jacket.

Selecting a listening mode

1 Play the selected device (page 37 – 67).

2 Press and hold **MOVIE**, **MUSIC** or **GAME** to select a listening mode.

This unit automatically generates and displays a list of selectable sound modes.

- Each time **MOVIE**, **MUSIC** or **GAME** is pressed, the listening mode is switched.

MOVIE Switches to the listening mode suitable for enjoying movies and TV programs.

MUSIC Switches to the listening mode suitable for enjoying music.

GAME Switches to the listening mode suitable for enjoying games.

- Pressing **MOVIE**, **MUSIC** or **GAME** displays a list of the listening modes that can be selected. Each time you press **MOVIE**, **MUSIC** or **GAME**, the listening mode changes.
- While the list is displayed, you can also use Δ / ∇ to select a listening mode.

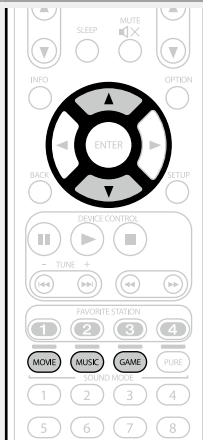

- The **MOVIE**, **MUSIC**, or **GAME** button memorizes the last sound mode selected for its button. Pressing **MOVIE**, **MUSIC**, or **GAME** recalls the same sound mode as the one selected at the previous playback.
- If the content played back does not support the previously selected sound mode, the most standard sound mode for the content is automatically selected.
- This can also be set by pressing **MOVIE**, **MUSIC**, or **GAME** on the main unit.

Direct playback

Sound recorded in source is played as is.

1 Play the selected device (page 37 – 67).



2 Press **PURE** to select “DIRECT”.

Direct playback begins.

Pure direct playback

This mode is for playback in higher sound quality than in “DIRECT” mode. Turn the display of the amplifier off to stop the analogue video circuit. This suppresses the source of noise that affects sound quality.

1 Play the selected device (page 37 – 67).



2 Press **PURE** to select “PURE DIRECT On”.

PURE DIRECT indicator on the main unit lights. The display goes dark, and pure direct playback begins.



- In DIRECT and PURE DIRECT listening mode, the following items cannot be adjusted.
 - Tone (page 114)
 - MultEQ[®] XT (page 116)
 - Dynamic EQ (page 117)
 - Dynamic Volume (page 117)
 - M-DAX (page 115)
- This can also be set by pressing **PURE DIRECT** on the main unit.

NOTE

- Video signals are only output when HDMI signals are played in the PURE DIRECT mode.
- When in the PURE DIRECT mode, the menu screen is not displayed.
- When in the PURE DIRECT mode, the display turns off and appears as if there is no electricity.

Auto surround playback

This mode detects the type of input digital signal, and automatically selects the corresponding mode for playback.

1 Play the selected device (☞ [page 37 – 67](#)).

2 Press **PURE** to select “**AUTO**”.

Auto surround playback begins.



This can also be set by pressing **PURE DIRECT** on the main unit.

Listening mode

- The following listening modes can be selected using the **MOVIE**, **MUSIC**, **GAME**, and **PURE** buttons.
- Adjust the sound field effect with the menu “Surround Parameter” (☞ [page 113](#)) to enjoy your favorite sound mode.

Operation button	Input signal	Listening mode	
MOVIE	2-channel *1	STEREO	
		AUTO *2	
		DOLBY PLIIx Movie *3	
		DOLBY PLII Movie *3 /	
		DOLBY PLII Movie A-DSX *5	
		DOLBY Pro Logic *3 /	
		DOLBY Pro Logic A-DSX *5	
		DTS NEO:6 Cinema *3 /	
		DTS NEO:6 Cinema A-DSX *5	
		DOLBY PLIIz Height *3	
	MULTI CH STEREO		
	VIRTUAL		
	Multi-channel *4	STEREO	
		AUTO *2	
	Dolby Digital	Dolby Digital	DOLBY DIGITAL /
			DOLBY DIGITAL A-DSX *5
			DOLBY DIGITAL EX
			DOLBY DIGITAL + PLIIx Movie
	Dolby TrueHD	Dolby TrueHD	DOLBY DIGITAL + PLIIz
			DOLBY TrueHD /
			DOLBY TrueHD A-DSX *5
			DOLBY TrueHD + EX
	Dolby Digital Plus	Dolby Digital Plus	DOLBY TrueHD + PLIIx Movie
			DOLBY TrueHD + PLIIz
			DOLBY DIGITAL Plus /
			DOLBY DIGITAL Plus A-DSX *5
	DTS	DTS	DOLBY DIGITAL Plus + EX
DOLBY DIGITAL Plus + PLIIx Movie			
DOLBY DIGITAL Plus + PLIIz			
DTS SURROUND /			
DTS SURROUND A-DSX *5			
DTS ES DSCRT 6.1			
DTS ES MTRX 6.1			
DTS 96/24			
DTS + NEO:6			
DTS + PLIIx Movie			
DTS + PLIIz			

Operation button	Input signal	Listening mode	
MOVIE	DTS-HD / DTS Express	DTS-HD HI RES /	
		DTS-HD HI RES A-DSX *5	
		DTS-HD MSTR /	
		DTS-HD MSTR A-DSX *5	
		DTS Express /	
		DTS Express A-DSX *5	
	PCM/DSD multi-channel	Multi-channel *4	DTS-HD + NEO:6
			DTS-HD + PLIIx Movie
			DTS-HD + PLIIz
			MULTI CH IN /
	Multi-channel *4	Multi-channel *4	MULTI CH IN A-DSX *5
			MULTI CH IN 7.1
			MULTI IN + Dolby EX
			MULTI IN + PLIIx Movie
		MULTI IN + PLIIz	
		MULTI CH STEREO	
		VIRTUAL	

- *1 2-channel also includes analog input.
- *2 When AUTO mode is selected, the sound mode that is compatible with the input signal is used for playback.
- *3 This mode plays back 2-channel source in 5.1 or 7.1-channel playback. It cannot be selected when headphones are used, or when only front speakers are used.
- *4 Some listening modes cannot be selected, depending on the audio format or number of channels of the input signal. For details, see “Types of input signals, and corresponding sound modes” (☞ [page 166](#)).
- *5 These modes add a new channel to the 5.1 channel surround using Audyssey DSX® processing (☞ [page 117](#)). When “On-Height-” is selected in Audyssey DSX® (☞ [page 117](#)), a front height channel is added in playback. When “On-Wide-” is selected, a front wide channel is added in playback.

Operation button	Input signal	Listening mode
MUSIC	2-channel *1	STEREO
		AUTO *2
		DOLBY PLIIx Music *3
		DOLBY PLII Music *3 /
		DOLBY PLII Music A-DSX *5
		DTS NEO:6 Music *3 /
		DTS NEO:6 Music A-DSX *5
	DOLBY PLIIz Height *3	
	MULTI CH STEREO	
	VIRTUAL	
	Multi-channel *4	STEREO
		AUTO *2
	Dolby Digital	DOLBY DIGITAL /
		DOLBY DIGITAL A-DSX *5
		DOLBY DIGITAL EX
		DOLBY DIGITAL + PLIIx Music
	Dolby TrueHD	DOLBY DIGITAL + PLIIz
		DOLBY TrueHD /
		DOLBY TrueHD A-DSX *5
		DOLBY TrueHD + EX
	Dolby Digital Plus	DOLBY TrueHD + PLIIx Music
		DOLBY TrueHD + PLIIz
		DOLBY DIGITAL Plus /
		DOLBY DIGITAL Plus A-DSX *5
	DTS	DOLBY DIGITAL Plus + EX
		DOLBY DIGITAL Plus + PLIIx Music
		DOLBY DIGITAL Plus + PLIIz
		DTS SURROUND /
DTS SURROUND A-DSX *5		
DTS ES DSCRT 6.1		
DTS ES MTRX 6.1		
DTS 96/24		
DTS + NEO:6		
DTS + PLIIx Music		
DTS + PLIIz		

Operation button	Input signal	Listening mode
MUSIC	DTS-HD / DTS Express	DTS-HD HI RES /
		DTS-HD HI RES A-DSX *5
		DTS-HD MSTR /
		DTS-HD MSTR A-DSX *5
		DTS Express /
		DTS Express A-DSX *5
		DTS-HD + NEO:6
	DTS-HD + PLIIx Music	
	DTS-HD + PLIIz	
	PCM/DSD multi-channel	MULTI CH IN /
		MULTI CH IN A-DSX *5
		MULTI CH IN 7.1
	Multi-channel *4	MULTI IN + Dolby EX
		MULTI IN + PLIIx Music
MULTI IN + PLIIz		
MULTI CH STEREO		
VIRTUAL		

- *1 2-channel also includes analog input.
- *2 When AUTO mode is selected, the sound mode that is compatible with the input signal is used for playback.
- *3 This mode plays back 2-channel source in 5.1 or 7.1-channel playback. It cannot be selected when headphones are used, or when only front speakers are used.
- *4 Some listening modes cannot be selected, depending on the audio format or number of channels of the input signal. For details, see "Types of input signals, and corresponding sound modes" (page 166).
- *5 These modes add a new channel to the 5.1 channel surround using Audyssey DSX® processing (page 117).
When "On-Height-" is selected in Audyssey DSX® (page 117), a front height channel is added in playback.
When "On-Wide-" is selected, a front wide channel is added in playback.

Operation button	Input signal	Listening mode
GAME	2-channel *1	STEREO
		AUTO *2
		DOLBY PLIIx Game *3
		DOLBY PLII Game *3 / DOLBY PLII Game A-DSX *5
		DOLBY PLIIz Height *3
		MULTI CH STEREO
		VIRTUAL
	Multi-channel *4	STEREO
		AUTO *2
	Dolby Digital	DOLBY DIGITAL / DOLBY DIGITAL A-DSX *5
		DOLBY DIGITAL EX DOLBY DIGITAL + PLIIz
		DOLBY TrueHD / DOLBY TrueHD A-DSX *5
	Dolby TrueHD	DOLBY TrueHD + EX DOLBY TrueHD + PLIIz
		DOLBY DIGITAL Plus / DOLBY DIGITAL Plus A-DSX *5
		DOLBY DIGITAL Plus + EX DOLBY DIGITAL Plus + PLIIz
	DTS	DTS SURROUND / DTS SURROUND A-DSX *5
		DTS ES DSCRT 6.1
		DTS ES MTRX 6.1
		DTS 96/24
		DTS + NEO:6
		DTS + PLIIz
	DTS-HD / DTS Express	DTS-HD HI RES / DTS-HD HI RES A-DSX *5
		DTS-HD MSTR / DTS-HD MSTR A-DSX *5
		DTS Express / DTS Express A-DSX *5
		DTS-HD + NEO:6
		DTS-HD + PLIIz
	PCM/DSD multi-channel	MULTI CH IN / MULTI CH IN A-DSX *5
MULTI CH IN 7.1		
MULTI IN + Dolby EX		
MULTI IN + PLIIz		
MULTI CH STEREO		
		VIRTUAL

Operation button	Input signal	Listening mode
PURE	All	DIRECT PURE DIRECT AUTO *2

- *1 2-channel also includes analog input.
- *2 When AUTO mode is selected, the sound mode that is compatible with the input signal is used for playback.
- *3 This mode plays back 2-channel source in 5.1 or 7.1-channel playback. It cannot be selected when headphones are used, or when only front speakers are used.
- *4 Some listening modes cannot be selected, depending on the audio format or number of channels of the input signal. For details, see "Types of input signals, and corresponding sound modes" (page 166).
- *5 These modes add a new channel to the 5.1 channel surround using Audyssey DSX® processing (page 117). When "On-Height-" is selected in Audyssey DSX®, a front height channel is added in playback. When "On-Wide-" is selected, a front wide channel is added in playback.

Views on the TV screen or display

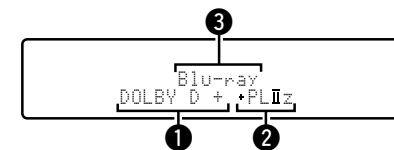

- 1 Shows a decoder to be used.
 - A DOLBY DIGITAL Plus decoder is displayed as "DOLBY D + PLIIz".
- 2 Shows a decoder that creates sound output from the surround back speakers.
 - "+ PLIIz" indicates the front height sound from front height speakers.
- 3 Shows the name of the input source being played back.

□ Description of listening mode types

Dolby listening mode

Listening mode type	Description
DOLBY PLIIx*1	This mode can be selected when a Dolby Pro Logic IIx decoder is used to play back 2-channel source in 6.1/7.1-channel surround sound including the surround back channel. By adding the surround back channel, a stronger surround feeling is obtained compared to Dolby Pro Logic II. There are three playback modes: "Movie" mode that is optimized for movie playback, "Music" mode that is optimized for music playback, and "Game" mode that is optimized for game play.
DOLBY PLII	This mode can be selected when a Dolby Pro Logic II decoder is used to play back 2-channel source in 5.1-channel surround sound with a natural, realistic feel.
DOLBY Pro Logic	This mode can be selected when a Dolby Pro Logic decoder is used to play 2-channel source in 4.1-channel surround sound (Left/Center/Right/Surround Mono).
DOLBY PLIIz*2	This mode can be selected when a Dolby Pro Logic IIz decoder is used to play back 2-channel source in 7.1-channel surround sound with added front height channel. By adding a front height channel, the vertical expression is emphasized, improving the three-dimensionality of the sound.
DOLBY DIGITAL	This mode can be selected when playing sources recorded with Dolby Digital.
DOLBY DIGITAL EX*1	Using a Dolby Digital EX decoder, this mode plays Dolby Digital source in 6.1/7.1 channel surround sound with added surround back channel. By adding a surround back channel, spacial expressiveness and sound localization are enhanced.
DOLBY TrueHD	This mode can be selected when playing sources recorded in Dolby TrueHD.
DOLBY DIGITAL Plus	This mode can be selected when playing sources recorded with Dolby Digital Plus.

*1 This can be selected when "Speaker Config." – "Surr. Back" is not set to "None".

*2 This can be selected when "Speaker Config." – "Front Height" is not set to "None".

DTS listening mode

Listening mode type	Description
DTS NEO:6	This mode can be selected when a DTS NEO:6 decoder is used to play back 2-channel source in 6.1/7.1-channel surround sound including the surround back channel. There is a "Cinema" mode optimized for movie playback, and a "Music" mode optimized for music playback.
DTS SURROUND	This mode can be selected when playing sources recorded in DTS.
DTS ES DSCRT6.1*	This mode is suitable for playing discs recorded in DTS-ES. The surround back channel added using the discrete method is played as an independent channel. Since all channels are independent, the 360-degree spacial expressiveness and sound localization are enhanced.
DTS ES MTRX6.1*	This mode is suitable for playing discs recorded in DTS-ES. The surround back channel added to the surround-left and surround-right channels by a matrix encoder at software recording time is decoded by this unit's matrix decoder and played from each channel (surround left, surround right, surround back).
DTS 96/24	This mode can be selected when playing sources recorded in DTS 96/24.
DTS-HD	This mode can be selected when playing sources recorded in DTS-HD.
DTS Express	This mode can be selected when playing sources recorded in DTS Express.

* This can be selected when "Speaker Config." – "Surr. Back" is not set to "None".

PCM multi-channel listening mode

Listening mode type	Description
MULTI CH IN	This mode can be selected when playing multi-channel PCM sources .

Audyssey DSX listening mode

Listening mode type	Description
Audyssey DSX (A-DSX)*	This mode creates playback for the new channels (front wide or front height) in 5.1-channel systems. By adding front wide or front high channels, the surround sound effects sound more three dimensional and realistic.

* This can be selected when a setting other than "None" is selected for "Front Height" or "Front Wide", and a setting other than "None" is selected for "Center" in "Speaker Config." (🔗 [page 131](#)).

Original listening mode

Listening mode type	Description
MULTI CH STEREO	This mode is for enjoying stereo sound from all speakers. The same sound as that from the front speakers (L/R) is played back at the same level from the surround speakers (L/R) and surround back speakers (L/R).
VIRTUAL	This mode is for enjoying surround effects using only the front speakers or headphones.

AUTO listening mode

Listening mode type	Description
AUTO	In this mode, the type of digital signal input, such as Dolby Digital, Dolby TrueHD, Dolby Digital Plus, DTS, DTS-HD, PCM (multi-channel) is detected, and the playback mode switches automatically to the corresponding mode. If the input signal is analog or PCM (2-channel), stereo playback is used.

STEREO listening mode







Listening mode type	Description
STEREO	This is the mode for playing in stereo. The tone can be adjusted. <ul style="list-style-type: none"> • Sound is output from the front left and right speakers and subwoofer. • If multichannel signals are input, they are mixed down to 2-channel audio and are played.

Direct listening mode

Listening mode type	Description
DIRECT	Sound recorded in source is played as is.
PURE DIRECT	This mode is for playback in higher sound quality than in DIRECT mode. Turn the display of the amplifier off to stop the analogue video circuit. This suppresses the source of noise that affects sound quality.

Advanced version

Here, we explain functions and operations that let you make better use of this unit.

- **Installation/connection/setup of speakers (Advanced)**  [page 82](#)
- **Connections (Advanced connection)**  [page 94](#)
- **Playback (Advanced operation)**  [page 96](#)
- **Playback in ZONE2/ZONE3 (Separate room)**  [page 104](#)
- **How to make detailed settings**  [page 107](#)
- **Operating external devices with the remote control**  [page 145](#)

Installation/connection/setup of speakers (Advanced)

Procedure for speaker settings

Speaker installation



Speaker connection (👉 [page 84](#))



Set up speakers (👉 [page 91](#))

Speaker installation

- Determine the speaker system depending on the number of speakers you are using and install each speaker and subwoofer in the room. Here, we explain how to install the speakers using a typical example.
- The speaker impedance should be from 6 to 8 Ω .

This unit is compatible with Audyssey DSX® (👉 [page 171](#)) and Dolby Pro Logic IIz (👉 [page 171](#)), which offers an even wider and deeper surround sensation. When using Audyssey DSX™, install front wide speakers or front height speakers. When using Dolby Pro Logic IIz, install front height speakers.



Use the illustration below as a guide for how high each speaker should be installed. The height does not need to be exactly the same.

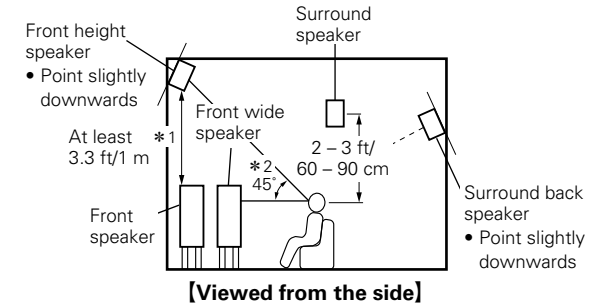

- *1 Recommended for Dolby Pro Logic IIz
- *2 Recommended for Audyssey DSX®

NOTE

You cannot have audio output from the surround back speakers, front height speakers and front wide speakers simultaneously.

When 7.1-channel speakers are installed using surround back, front height, and front wide speakers

When using Audyssey DSX®, install front wide speakers or front height speakers.

When using Dolby Pro Logic IIz, install front height speakers.

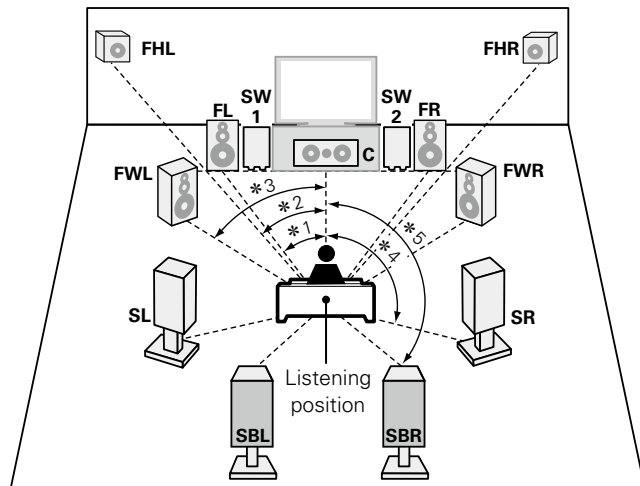

- *1 22° - 30°
- *2 22° - 45°
- *3 55° - 60°
- *4 90° - 110°
- *5 135° - 150°

[Speaker abbreviations]

- FL** Front speaker (L)
- FR** Front speaker (R)
- C** Center speaker
- SW** Subwoofer
- SL** Surround speaker (L)
- SR** Surround speaker (R)
- SB** Surround back speaker
- SBL** Surround back speaker (L)
- SBR** Surround back speaker (R)
- FHL** Front height speaker (L)
- FHR** Front height speaker (R)
- FWL** Front wide speaker (L)
- FWR** Front wide speaker (R)

When 6.1ch speakers are installed

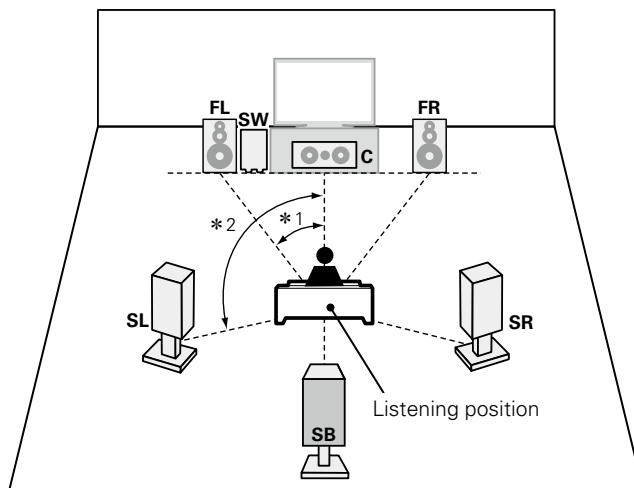

- *1 22° - 30°
- *2 90° - 110°

When 5.1ch speakers are installed

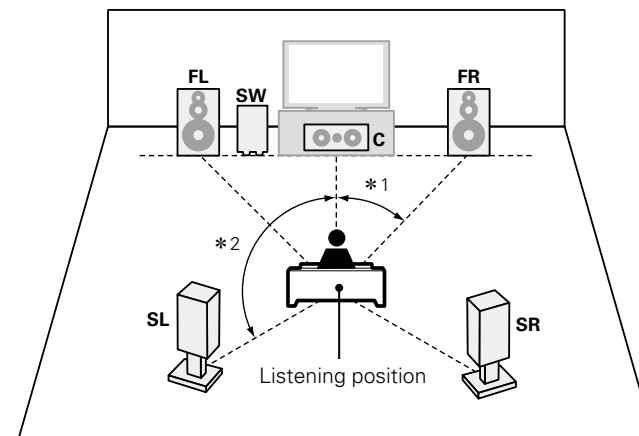

- *1 22° - 30°
- *2 120°

When Front A/B speakers are installed

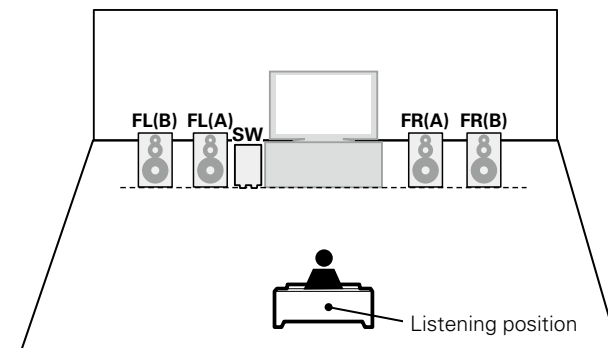

Speaker connection

Here, we connect the speakers in the room to this unit.
This section explains how to connect them using a typical example.

- ❑ **Connecting 7.1-channel speakers using surround back, front height, and front wide speakers** (👉 [page 85](#))
- ❑ **Connecting 6.1-channel speakers using one surround back speaker** (👉 [page 86](#))
- ❑ **Connecting 5.1-channel speakers** (👉 [page 87](#))
- ❑ **Connecting front A/B speakers** (👉 [page 88](#))
- ❑ **Connecting 2.1-channel speakers** (👉 [page 89](#))
- ❑ **Connecting front speakers with a bi-amp connection** (👉 [page 90](#))

NOTE

- Disconnect this unit's power plug from the power outlet before connecting the speakers. Also, turn off the subwoofer.
- Connect so that the speaker cable core wires do not protrude from the speaker terminal. The protection circuit may be activated if the core wires touch the rear panel or if the + and - sides touch each other (👉 [page 173](#) "Protection Circuit").
- Never touch the speaker terminals while the power supply is connected. Doing so could result in electric shock. When the "Setup Assistant" is running, follow the instructions in the "Setup Assistant" screen for making connections. (Power is not supplied to the speaker terminals while the "Setup Assistant" is running.)
- Use speakers with the speaker impedances shown below.

Speaker terminals	Speaker impedance
FRONT	6 - 8 Ω
CENTER	
SURROUND	
SURROUND BACK	
FRONT HEIGHT	
FRONT WIDE	

Connecting the speaker cables

Carefully check the left (L) and right (R) channels and + (red) and - (black) polarities on the speakers being connected to this unit, and be sure to interconnect the channels and polarities correctly.

- 1** Peel off about 0.03 ft/10 mm of sheathing from the tip of the speaker cable, then either twist the core wire tightly or terminate it.



- 2** Turn the speaker terminal counterclockwise to loosen it.

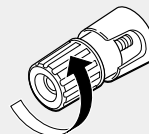

- 3** Insert the speaker cable's core wire to the hilt into the speaker terminal.

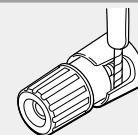

- 4** Turn the speaker terminal clockwise to tighten it.

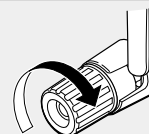

Connecting the subwoofer

Use a subwoofer cable to connect the subwoofer.

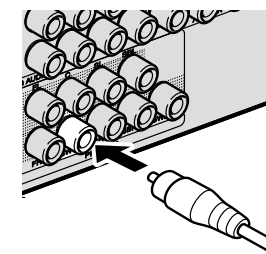

- ❑ **For connecting two subwoofers**

Two subwoofers can be connected to this unit.
The same signal is output from each subwoofer terminal.

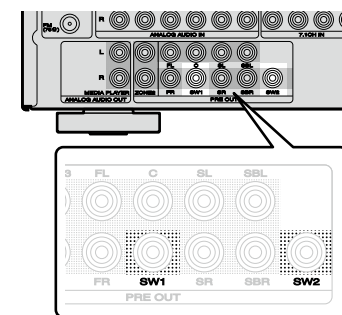

Connecting 7.1-channel speakers using surround back, front height, and front wide speakers

The illustration on the right shows a connection example for performing 7.1-channel playback using the surround back, front height or front wide speakers.

If you connect the surround back, front height and front wide speakers before you start playback, the audio is played back by automatically switching the speakers in accordance with the surround mode or input signals.

To perform 7.1-channel playback using the surround back, front height or front wide speakers, set "Assign Mode" to "Main Only" in steps 3 to 5 for "Set up "Amp Assign"" (see page 91).

Cables used for connections

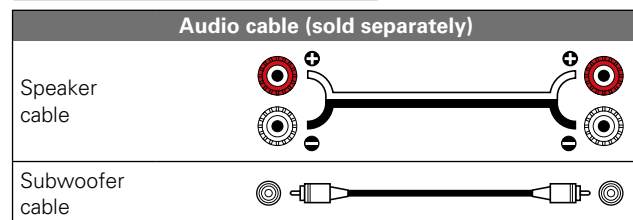

NOTE

- For speaker cable connections, see [page 84](#).
- For speaker impedance, see [page 84](#).

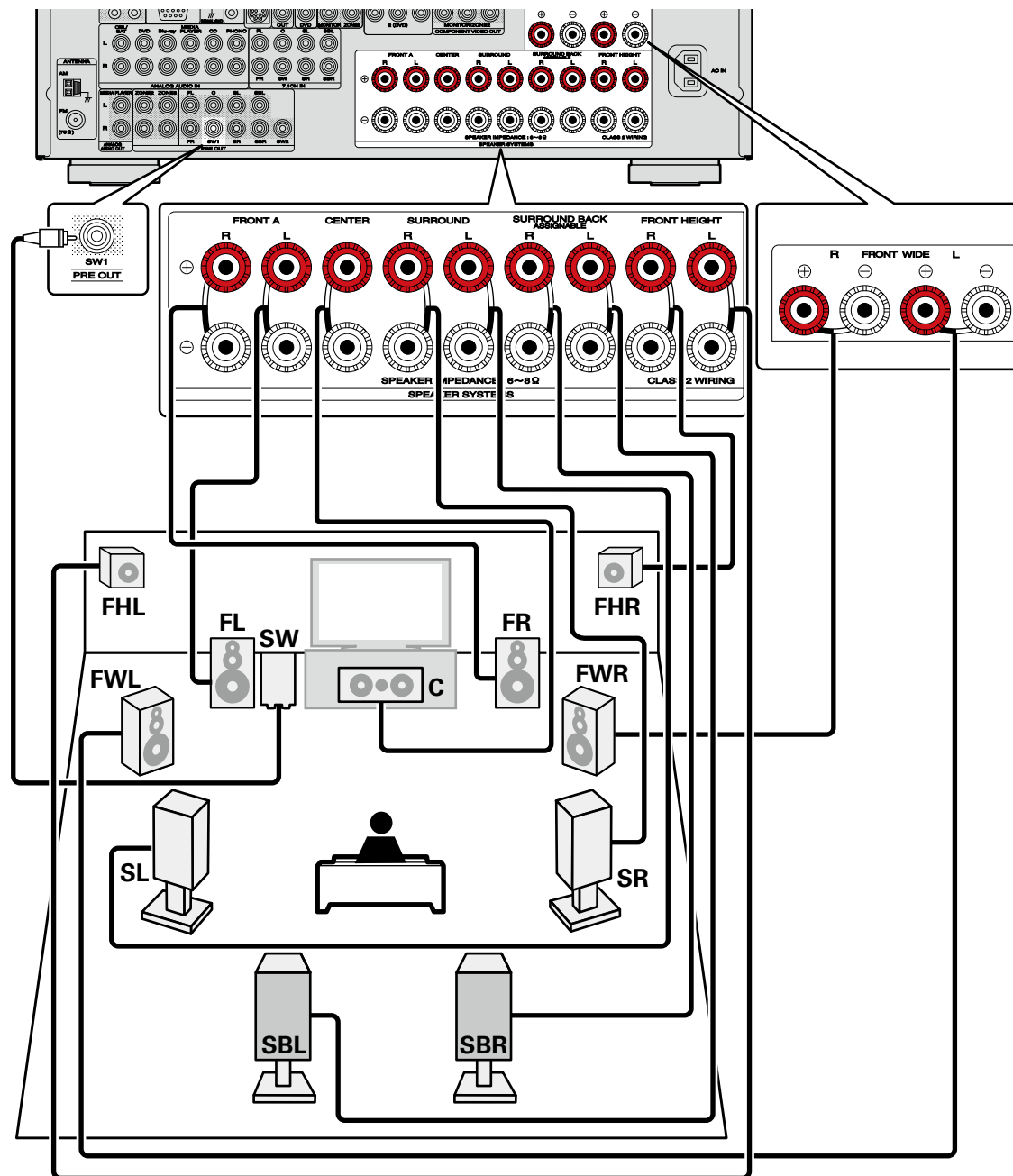

Connecting 6.1-channel speakers using one surround back speaker

If using only one surround back speaker, connect to the "L" side of the SURROUND BACK terminal. For speaker settings in this case, see "When 6.1ch speakers are installed" ([page 83](#)). To perform 6.1-channel playback using the surround back speaker, set "Assign Mode" to "Main Only" in steps 3 to 5 for "Set up "Amp Assign"" ([page 91](#)). Also use the "Speaker Config." setting ([page 132](#)) to set "Surr. Back" to "1spkr".

Cables used for connections

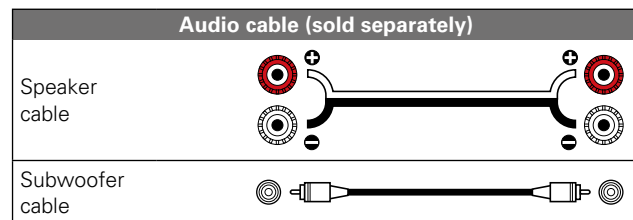

NOTE

- For speaker cable connections, see [page 84](#).
- For speaker impedance, see [page 84](#).

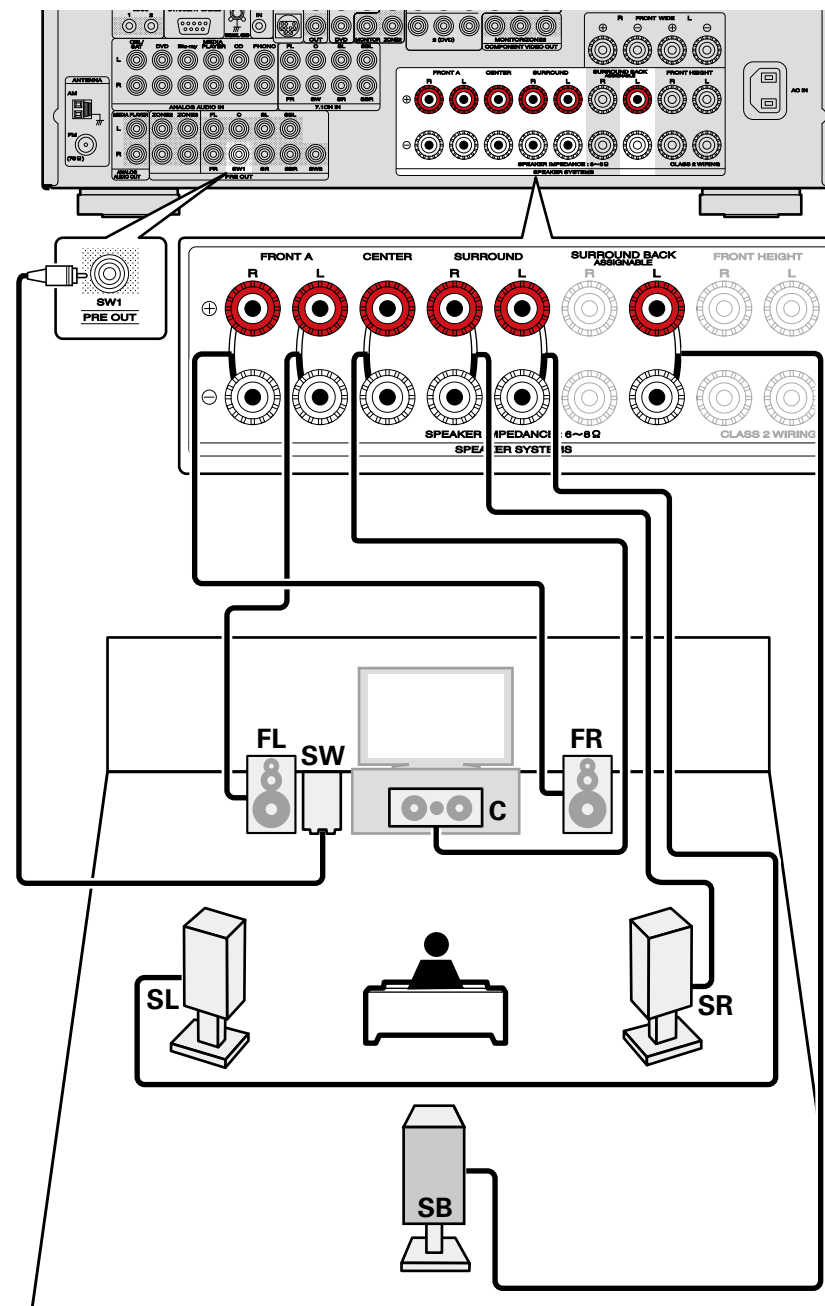

Connecting 5.1-channel speakers

To perform 5.1-channel playback, set "Assign Mode" to "Main Only" in steps 3 to 5 for "Set up "Amp Assign"" (page 91).

Cables used for connections

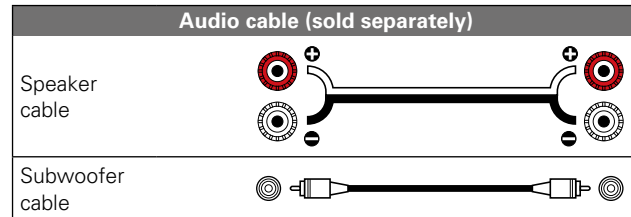

NOTE

- For speaker cable connections, see [page 84](#).
- For speaker impedance, see [page 84](#).

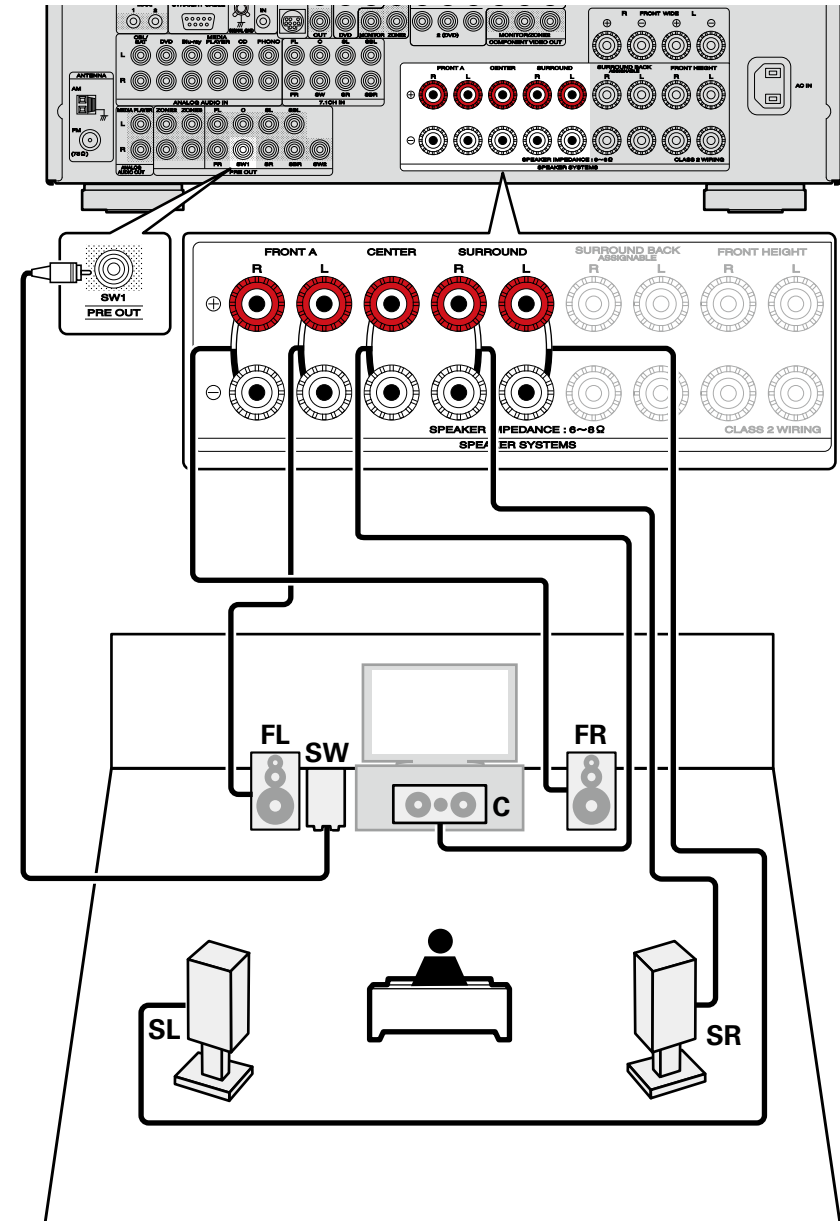

Connecting front A/B speakers

You can connect a second set of speakers to this unit and use them for playback. In this case, set "Assign Mode" to "Front B" in steps 3 to 5 for "Set up "Amp Assign"" ([page 91](#)).

Cables used for connections

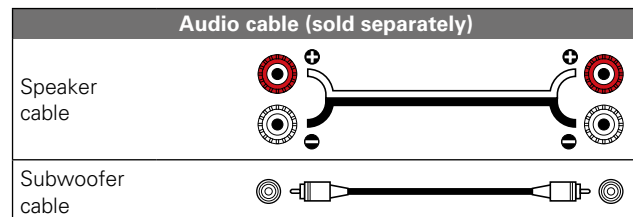

For multichannel playback, connect center, surround, surround back, and front speakers and a subwoofer. Front speakers can be used separately, depending on the speaker's specifications or playback source such as front speakers (A) for multichannel playback and front speakers (B) for 2-channel playback ([page 134](#) "Front Speaker").

NOTE

- For speaker cable connections, see [page 84](#).
- For speaker impedance, see [page 84](#).

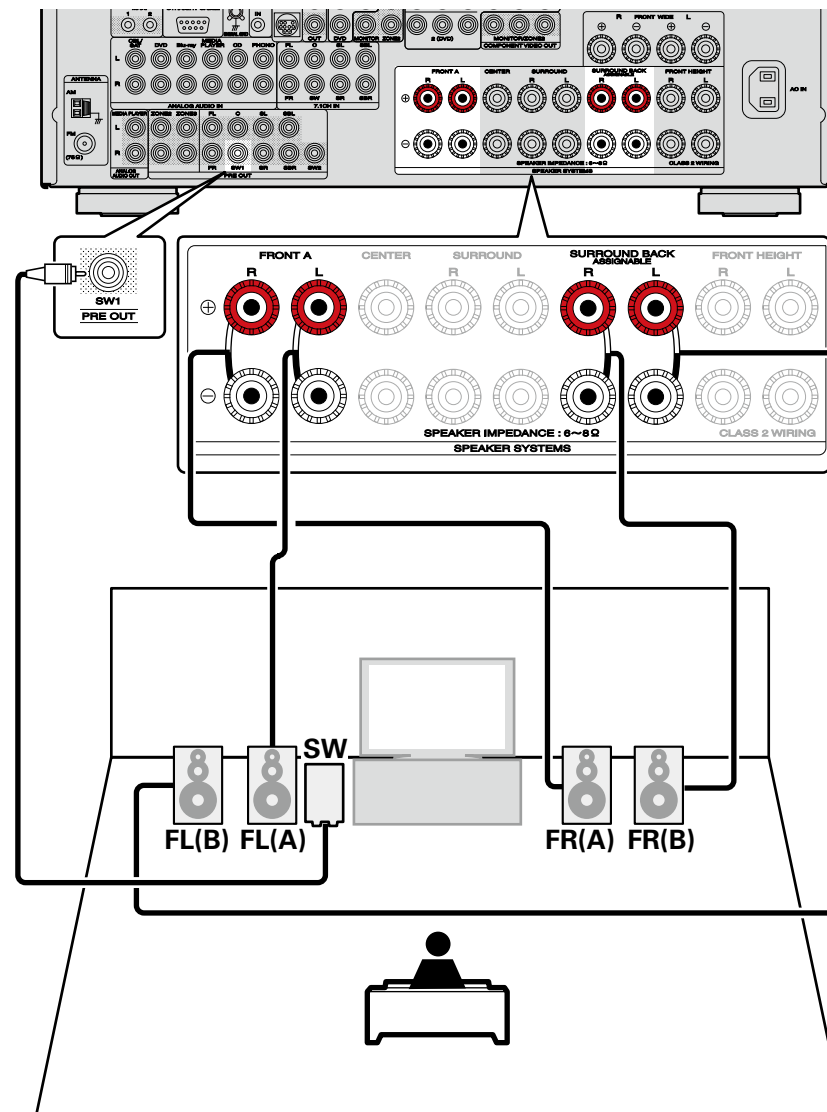

Connecting 2.1-channel speakers

Cables used for connections

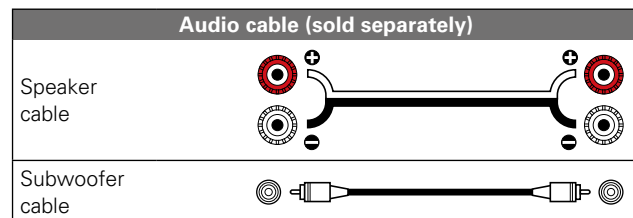

NOTE

- For speaker cable connections, see [page 84](#).
- For speaker impedance, see [page 84](#).

For connecting two subwoofers

Two subwoofers can be connected to this unit.
The same signal is output from each subwoofer terminal.

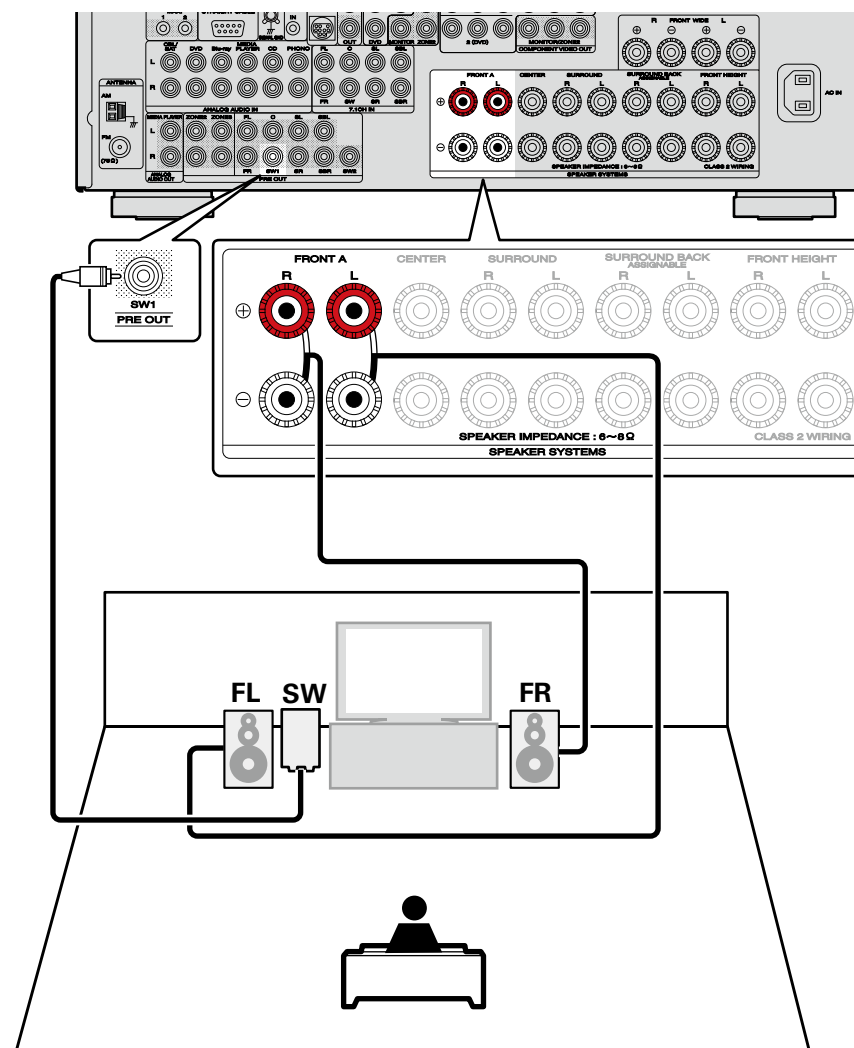
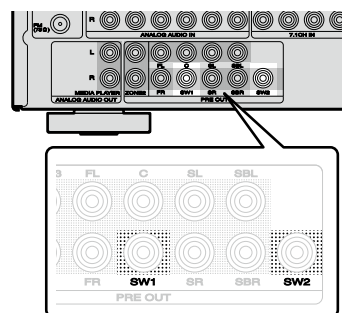

Connecting front speakers with a bi-amp connection

- You cannot use surround back speakers in a bi-amp connection. Use front speakers that support a bi-amp connection and connect the speakers to the FRONT speaker terminals and the SURROUND BACK speaker terminals.
- In this case, set "Assign Mode" to "Bi-AMP" in steps 3 to 5 for "Set up "Amp Assign"" (page 91).
- A bi-amp connection is to connect separate amplifiers to the tweeter terminals and woofer terminals of speakers compatible with the bi-amp function. This prevents the back electromotive force (returned force without output) of the woofer sent to the tweeter, which affects the sound quality of the tweeter, and you can enjoy playback with higher-quality sound.

Cables used for connections

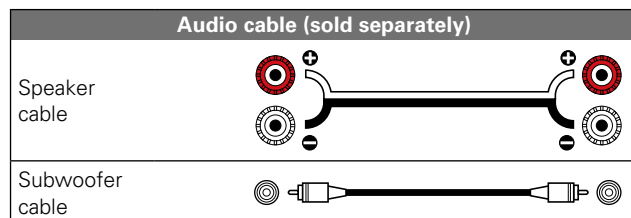

For multichannel playback, connect front, center and surround speakers and a subwoofer.

NOTE

- For speaker cable connections, see page 84.
- For speaker impedance, see page 84.
- When making bi-amp connections, be sure to remove the short-circuiting plate or wire between the speaker's woofer and tweeter terminals.

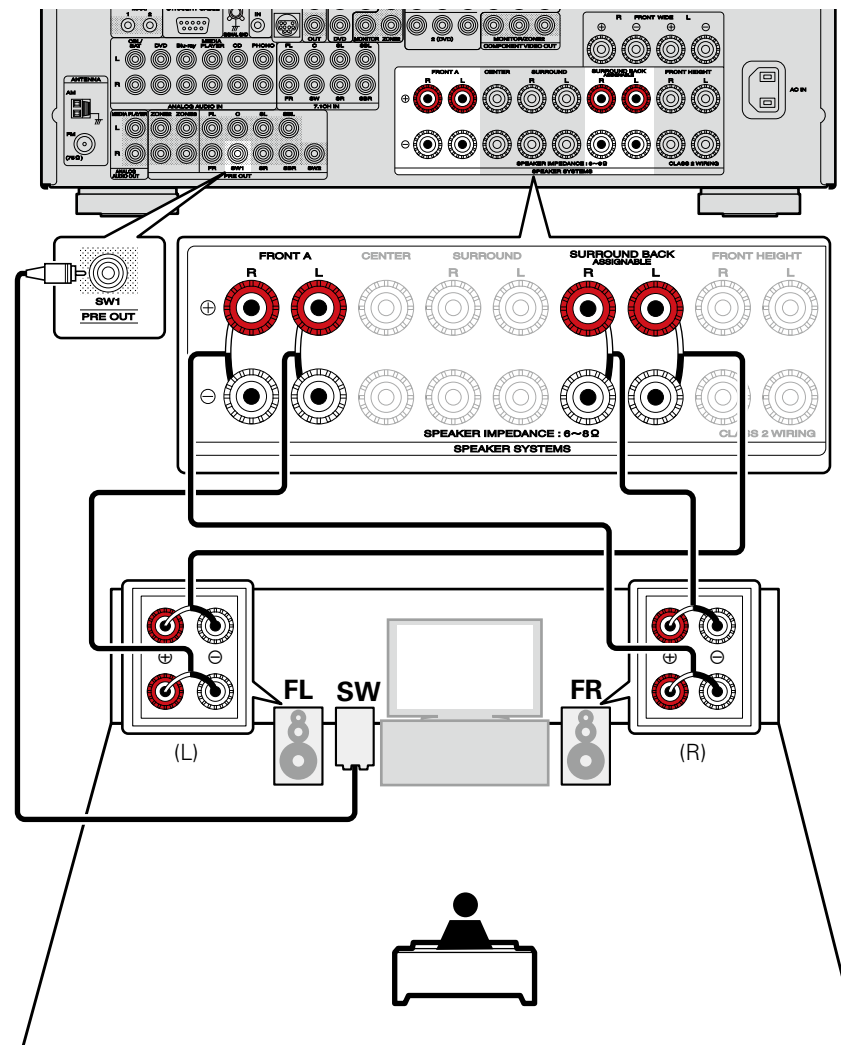

Set up speakers

 around items indicate the settings.

This section describes detailed settings for Audyssey® Setup.

First install and connect the speakers to this unit.

Before Audyssey® Setup measurement, the settings shown below can be made.

- Changing the amplifier assignment (Amp Assign)

The signal output from the SURROUND BACK speaker terminal of this unit can be switched to match your speaker environment ([page 91](#) “Set up “Amp Assign””).

- Setting the channels to be used (Channel Select)

If channels that are not to be used are set in advance, measurement for the set channels is skipped, and measuring time can be reduced. You can also change the number of surround back speakers ([page 92](#) “Set up “Channel Select””).

1

Set up the remote control unit

- Set up the zone mode

Press **ZONE SELECT** to switch “MAIN”.

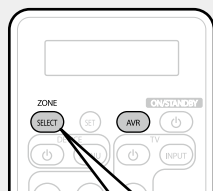

Press **ZONE SELECT**

NOTE

When using a remote control with preset codes registered ([page 148](#)), press **AVR** to set the remote control to the AVR-operation mode before operation.

2

Connect the setup microphone.

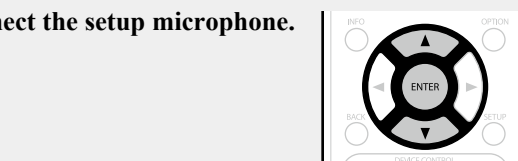

When the setup microphone is connected, the following screen is displayed.



3

Set up “Amp Assign”

Use Δ / ∇ to select “Amp Assign”, and then press **ENTER**.

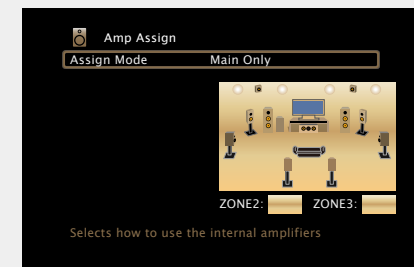

4

 Select “Assign Mode”, and then press **ENTER**.

5 Use \triangleleft \triangleright to select the configuration of the connected speakers, and then press **ENTER**.

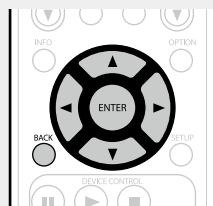

Main Only Setting for 7.1-channel playback using surround back, front height, or front wide speakers.

ZONE2 Setting to assign the unit's built-in power amplifier for ZONE2 and output the audio in stereo.

ZONE3 Setting to assign the unit's built-in power amplifier for ZONE3 and output the audio in stereo.

Bi-AMP Setting to use the front speakers via the bi-amp connection.

Front B Setting to use the second set of front speakers for playback.

6 Press \triangleleft or **BACK** to exit the "Amp Assign" setting.

7 Set up "Channel Select"

Use \triangle ∇ to select "Channel Select", and then press **ENTER**.

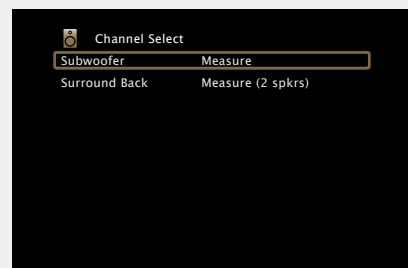
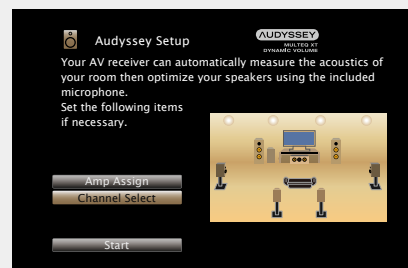

8 Use \triangle ∇ to select a channel, and then press **ENTER**.

Subwoofer Select for no subwoofers to be used. In this case, go to step 9.

Surround Back Select the number of surround back speakers to be used. In this case, go to step 10.

- "Surround Back" can be set when "Assign Mode" is set to "Main Only".

Front Height Select for no front height speakers to be used. In this case, go to step 11.

- "Front Height" can be set when "Assign Mode" is set to "Main Only".

Front Wide Select for no front wide speakers to be used. In this case, go to step 12.

- "Front Wide" can be set when "Assign Mode" is set to "Main Only".

9 Use \triangleleft \triangleright to set whether or not a subwoofer channel is measured, and then press **ENTER**.

Measure Set for measuring a subwoofer.

Skip Set for no measuring of a subwoofer.

10 Use \triangleleft \triangleright to set whether or not a surround back channel is measured, and then press **ENTER**.

Measure (2spkr) Set for measuring two surround back speakers.

Measure (1spkr) Set for measuring a surround back speaker.

Skip Set for no measuring of a surround back speaker.

11 Use ◀▶ to set whether or not a front height channel is measured, and then press **ENTER**.

Measure Set to measure the front height speakers.

Skip Set when you do not want to measure the front height speakers.

12 Use ◀▶ to set whether or not a front wide channel is measured, and then press **ENTER**.

Measure Set to measure the front wide speakers.

Skip Set when you do not want to measure the front wide speakers.

13 Press ◀ or **BACK**.

Proceed to [page 31](#) **Preparation** ▶ step 5.

NOTE

After performing Audyssey® Setup, do not change the speaker connections or subwoofer volume. In event of a change, perform Audyssey® Setup again.

Connections (Advanced connection)

Connecting the REMOTE CONTROL connectors

Performing operations on this unit and external devices

- You can connect an IR receiver to this unit to perform operations on this unit and external devices with the supplied remote control unit.
- To do this, disable the remote control signal receiving function ([page 102](#) "Remote lock function").

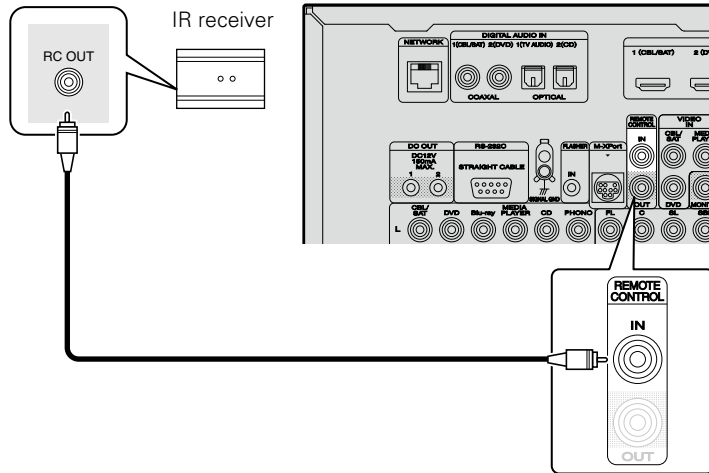

NOTE

When not connecting an IR receiver, make sure to enable the remote control signal receiving function. When the function is disabled, you can not perform operations with the remote control unit.

Remotely connecting marantz devices

- When you are using a marantz device other than this unit that supports remote connection, an IR receiver is not necessary.
- You can transmit remote control signals just by connecting the device to the REMOTE CONTROL IN/OUT connector with a monaural cable.
- Set the remote control switch located on the rear panel of the connected audio component to "EXTERNAL" or "EXT." to use this feature.
- If a marantz power amplifier (excluding certain models) is connected to any of these connectors, the power of the power amplifier switches to on/standby in conjunction with the **ON/STANDBY** button of the this unit.

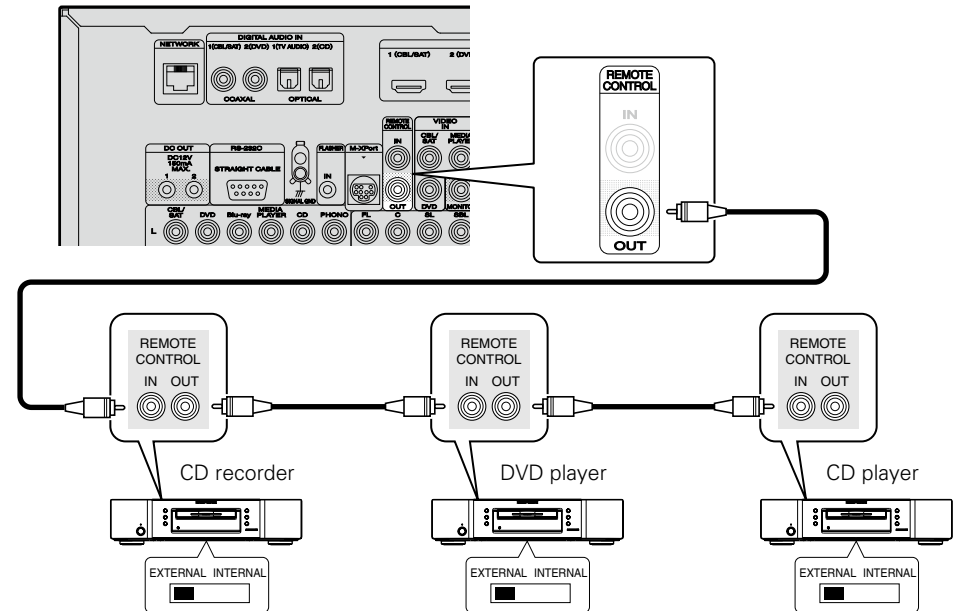

Connecting an external control device

RS-232C connector

When you connect an external control device, you can control this unit with the external control device (such as power supply operation, volume adjustment, and input source switching).

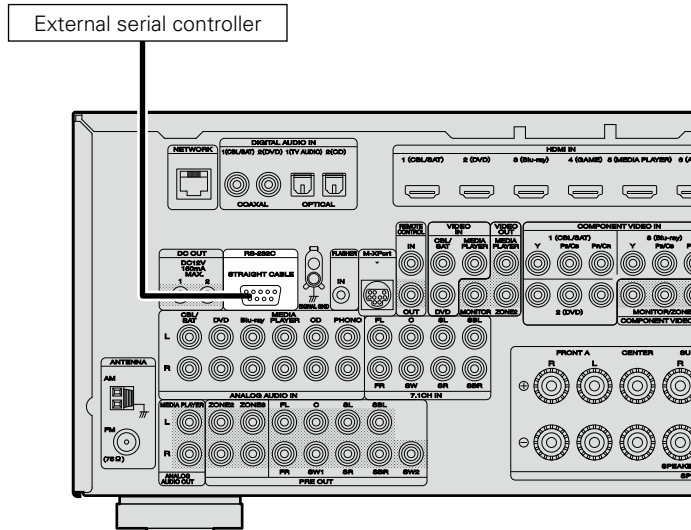

Perform the operation below beforehand.

- ① Turn on the power of this unit.
- ② Turn off the power of this unit from the external controller.
- ③ Check that the unit is in the standby mode.

DC OUT jacks

When a device with DC IN jack is connected, the connected device's power on/standby can be controlled through linked operation to this unit.

The DC OUT jack outputs a maximum 12 V/150 mA electrical signal.

12 V/150 mA trigger-compatible device

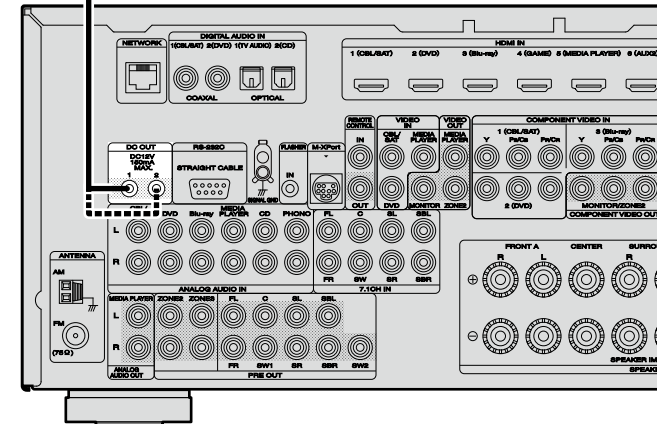

NOTE

- Use the monaural mini-plug cable for connecting DC OUT jacks. Do not use the stereo mini-plug cable.
- If the permissible trigger input level for the connected device is larger than 12 V/150 mA, or has shorted, the DC OUT jack cannot be used. In this case, turn off the power to the unit, and disconnect it.

Playback (Advanced operation)

Setup (👉 page 29)

Playback (Basic operation) (👉 page 36)

Selecting a listening mode (Sound Mode)
(👉 page 75)

Connections (Advanced connection) (👉 page 94)

- ❑ HDMI control function (👉 page 96)
- ❑ Sleep timer function (👉 page 98)
- ❑ Web control function (👉 page 99)
- ❑ Dual backup memory function (👉 page 101)
- ❑ Panel lock function (👉 page 101)
- ❑ Remote lock function (👉 page 102)
- ❑ Switches light illumination on/off (👉 page 103)
- ❑ Various memory functions (👉 page 103)

HDMI control function

If you connect the unit and an HDMI control function compatible TV or player with an HDMI cable and then enable the HDMI control function setting on each device, the devices will be able to control each other.

❑ Operations possible by HDMI control

- **This unit power off can be linked to the TV power off step.**
- **You can switch audio output devices with a TV operation.**
When you set "Output audio from amp" in the TV audio output setup operation, you can switch the amp power on.
- **You can adjust this unit volume in the TV volume adjustment operation.**
- **You can switch this unit input sources through linkage to TV input switching.**
- **When playing the player, this unit input source switches to the source for that player.**
- **If you switch the input source of the unit to "TV AUDIO", you can play TV audio with this unit (👉 page 9 "About ARC (Audio Return Channel) function").**
- **When "HDMI Control" (👉 page 121) in the menu is set to "On", signals input to the HDMI input connector are output to the television or other device connected to the HDMI output connector, even if the power of this unit is in standby (pass-through function).**



- To use this unit to play the audio of a TV that does not support the ARC function, connect the TV with an optical-digital or analog connection (👉 page 9).
- To use the pass-through function, connect an HDMI connection device that is compatible with HDMI control.

❑ Setting procedure

- 1 Set the HDMI output connector corresponding with the HDMI control function.**
Set "HDMI Control" (👉 page 121) to "On".
- 2 Turn the power on for all the devices connected by HDMI cable.**
- 3 Set the HDMI control function for all devices connected by HDMI cable.**
 - Please consult the operating instructions for the connected devices to check the settings.
 - Carry out steps 2 and 3 should any of the devices be unplugged.
- 4 Switch the television input to the HDMI input connected to this unit.**
- 5 Switch this unit input to the HDMI input source and check if the picture from the player is ok.**
- 6 When you turn the TV's power to standby, check that the power of this unit also goes to standby.**



If the HDMI control function does not operate properly, check the following points.

- Is the TV or player compatible with the HDMI control function?
- Is "HDMI Control" ([page 121](#)) set to "On"?
- Is "Power Off Control" ([page 121](#)) set to "All" or "Video"?
- Is "Control Monitor" ([page 121](#)) set for the monitor output connected to television?
- Is "Control Monitor" ([page 121](#)) set to the TV that uses the HDMI control function when this unit is connected to two TVs that support HDMI connectors?
- Are the HDMI control function settings of all devices correct?

NOTE

- **When "HDMI Control" is set to "On", it consumes more standby power.**
- The HDMI control function controls operations of a TV that is compatible with the HDMI control function. Make sure that the TV and HDMI are connected when you perform HDMI control.
- Some functions may not operate depending on the connected TV or player. Check the owner's manual of each device for details beforehand.
- When "Power Off Control" on the menu is set to "Off" ([page 121](#)), this unit is not set to standby even if the connected device is in the standby mode.
- When connection changes are implemented, such as adding connections to HDMI devices, linked operations may be initialized. In this case, you will need to reconfigure the settings.
- When "HDMI Control" is set to "On", it is not possible to assign an HDMI connector to "TV AUDIO" at "Input Assign" ([page 126](#)).
- Should any of the operations below be performed, the interlocking function may be reset, in which case, repeat steps 2 and 3.
 - "Input Assign" – "HDMI" ([page 126](#)) setting has changed.
 - "Video Output" ([page 121](#)) setting is changed.
 - There is a change to the connection between the devices and the HDMI, or an increase in devices.
- The HDMI ZONE2 function is not compatible with the HDMI control function.
- When the HDMI ZONE2 function is used with "HDMI Control" in the menu set to "On", the HDMI ZONE2 function may not fully work.
- If "HDMI Control" in the menu is set to "On" and the power of ZONE2 is on, this units may behave as follows. It is recommended to disable the HDMI control function on your TV and player when using the HDMI ZONE2 function. (Some example behaviors are listed below.)
 - When the power of the TV used for MAIN ZONE is off and the player selected for ZONE2 starts playback, the TV used for MAIN ZONE is turned on. In this case, the input source selected for MAIN ZONE changes to the input source selected for ZONE2.
 - When playing back a TV used for MAIN ZONE and ZONE2 with an HDMI connection, turning off the TV used for MAIN ZONE also turns off this unit and the player.
 - When a same input source is selected for MAIN ZONE and ZONE2, stopping playback of the player on the TV stops the playback on the player and the video being played back in ZONE2 as well.

Sleep timer function

- You can have the power automatically switched to standby once a set time has elapsed. This is convenient for viewing and listening while going to sleep.
- The sleep timer function can be set for each zone ([page 106](#) "Sleep timer function"). (The MAIN ZONE setting method is explained here.)

1 Press **ZONE SELECT** to switch "MAIN".

2 Press **SLEEP** and display the time you want to set.

The **S** indicator on the display lights.



- The time switches as shown below each time **SLEEP** is pressed.

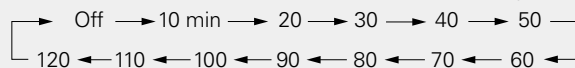

To confirm the countdown time before putting the unit to sleep

Press **SLEEP**.

"Sleep : *min" appears on the display.

* Countdown time

To cancel the sleep timer

Press **SLEEP** to set "Off".

The **S** indicator on the display turns off.



- The sleep timer setting is canceled if this unit's power is set to standby.
- The sleep timer function can be set separately for the different zones ([page 106](#) "Sleep timer function").

NOTE

The sleep timer function cannot turn off the power of devices connected to this unit. To turn off the power of those connected devices, set up sleep timers on the connected devices themselves.

Web control function

You can control this unit from a web control screen on a web browser.



- This unit and the PC need to be connected to the network properly (☞ [page 27](#) “Connecting to a home network (LAN)”) in order to use the web control function.
- Depending on the settings of your security-related software, you may not be able to access this unit from your PC. If this is the case, then change the settings of the security-related software.

1 Switch the “IP Control” setting to “Always On” (☞ [page 136](#)).

2 Check the IP address of this unit with “Information” (☞ [page 136](#)).

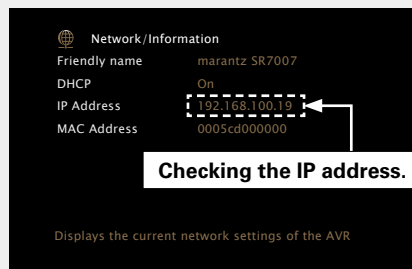

3 Start up the web browser.

4 Enter the IP address of this unit in browser’s address box.

For example, if the IP address of this unit is “192.168.100.19”, enter “http://192.168.100.19/”.

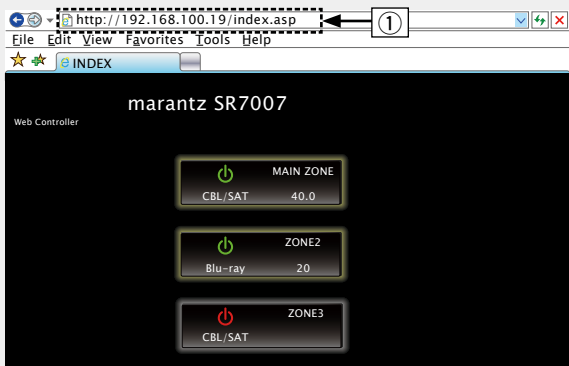

① Entering the IP address.

- By adding this unit’s IP address to the browser’s bookmark, you can display the web control screen using the bookmark function the next time you use the browser. If you are using a DHCP server and “IP Control” (☞ [page 136](#)) is set to “Off In Standby”, turning the power on/off changes the IP address.

5 When the top menu is displayed, click on the menu item you want to operate.

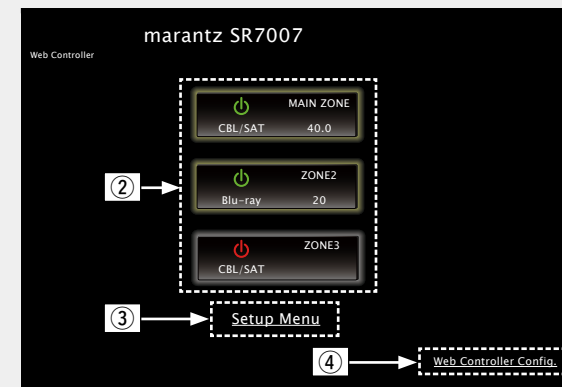

② Click when you select the zone to operate. (☞ [Example 1](#))

③ Click when you operate the setup menu.

④ Click to change the Web control screen setting.

(☞ [Example 3](#))

6 Operate.

[Example 1] MAIN ZONE control screen

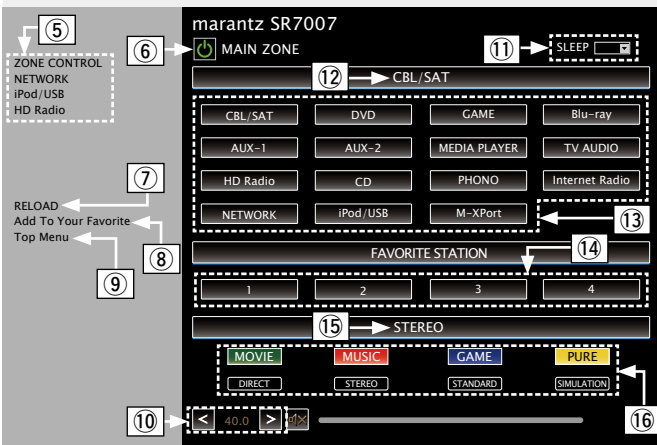

- ⑤ Click the menu item from which you want to make settings. The display on the right becomes the individual setting screens. (Example 4)
- ⑥ Click when you perform a power operation of the unit.
- ⑦ Click when you update to the latest information. Normally, there is a change to the latest information each time you operate. When operating from the main unit, click this or else the screen will not be updated.
- ⑧ Click to add a setting to "Favorites" in your browser. We recommend registering the setting screens for the different zones in the browser's favorites so as not to accidentally perform menu operations for zones you do not intend to operate.
- ⑨ Click to return to the top menu. Displayed when setting "Top Menu Link Setup" to "ON" in [Example 3]
- ⑩ To adjust the main volume, click "<", ">", or the volume display.
- ⑪ Click "v" to set the sleep timer function.
- ⑫ Displays the name of the selected input source.
- ⑬ Click a button to change the input source.
- ⑭ Register your favorite content.
- ⑮ Displays the sound mode.
- ⑯ The sound mode switches each time you click the button.

[Example 2] Setup menu screen

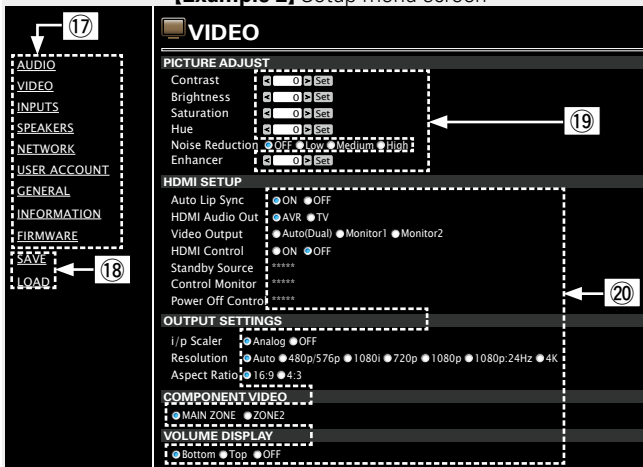

- ⑰ Click the menu item from which you want to make settings. The display on the right becomes the individual setting screens.
- ⑱ Click "SAVE" when you want to save settings, and click "LOAD" when you want to call settings.
- ⑲ Enter figures or click "<" or ">" to make the setting, and then click "Set".
- ⑳ Click an item to make a setting.

[Example 3] Web configuration screen

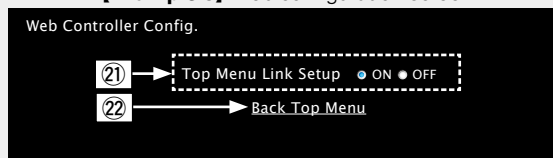

- ㉑ Click "ON" when performing Top Menu Link Setup. When set up, return to the top menu from each operation screen. (Default setting : "OFF")
- ㉒ Click this item to return to the top menu.

[Example 4] Network audio operating screen

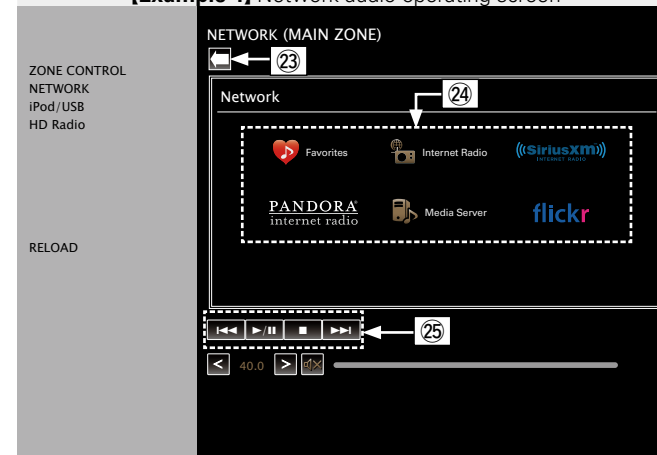

- ㉓ Click to return to the previous screen.
- ㉔ Click the content you want to operate.
- ㉕ Use to operate content.

Dual backup memory function

The unit stores settings information in nonvolatile memory even when the main power supply is turned off. Using the Dual Backup Memory function, you can write settings information to another memory area to back up saved settings for recovery anytime as needed. Remembering set details (Backup).

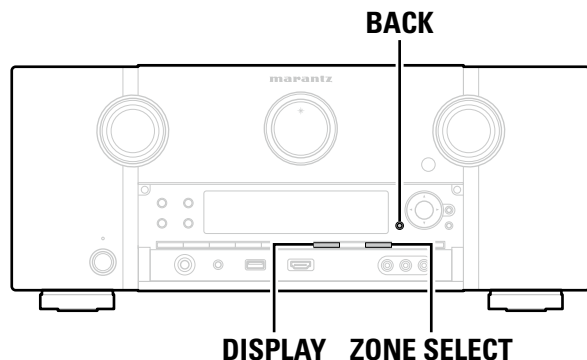

Remembering set details (Backup)

Set the unit in the state you want remembering, and press and hold **DISPLAY** and **ZONE SELECT** for at least 3 seconds.

"MEMORY SAVING" is shown in the display, and the setting details are remembered.

NOTE

- The volume is not remembered.
- If remembered details are overwritten, the previously remembered contents are deleted.

Recalling remembered details (Recovery)

Press and hold **BACK** and **ZONE SELECT** together for at least 3 seconds.

"MEMORY LOAD" is shown in the display, and the remembered details are recalled.

NOTE

- If there is no remembered data, "NO BACKUP" is shown in the display, and no remembered details are recalled.
- As the volume cannot be recalled, it returns to the factory setting volume.

Panel lock function

To prevent accidental operation of this unit, you can disable operation of the buttons on the front panel.

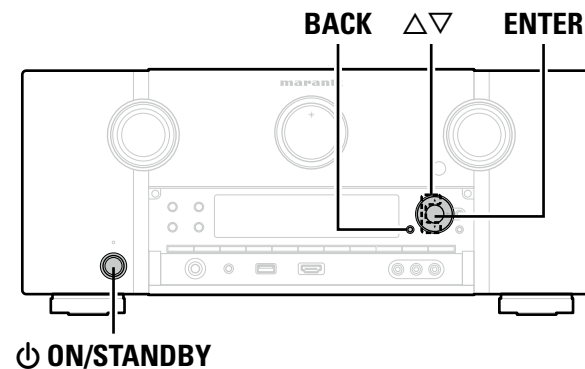

Disabling all key button operations

- 1 Press **ON/STANDBY** while you press and hold **BACK** and **ENTER** with the unit in standby mode.
- 2 Press **Δ∇** to select "FP/VOL LOCK ON".
- 3 Press **ENTER** to enter the setting.
All button operations except **ON/STANDBY** are disabled.

Disabling all button operations except VOLUME

- 1 Press **ON/STANDBY** while you press and hold **BACK** and **ENTER** with the unit in standby mode.
- 2 Press **Δ∇** to select "FP LOCK ON".
- 3 Press **ENTER** to enter the setting.
All button operations except **ON/STANDBY** and **VOLUME** are disabled.

❑ Canceling the Panel lock function

- 1** Press **ON/STANDBY** while you press and hold **BACK** and **ENTER** with the unit in standby mode.
- 2** Press **△▽** to select “FP LOCK *Off”.
(* The currently set mode.)
- 3** Press **ENTER** to enter the setting.
The Panel lock function is canceled.



Even when the Panel lock function is set, you can operate the unit using the remote control unit.

Remote lock function

- When not connecting an IR receiver, disable the Remote lock function. When the function is enabled, you can not perform operations with the remote control unit.
- By default, this function is disabled.

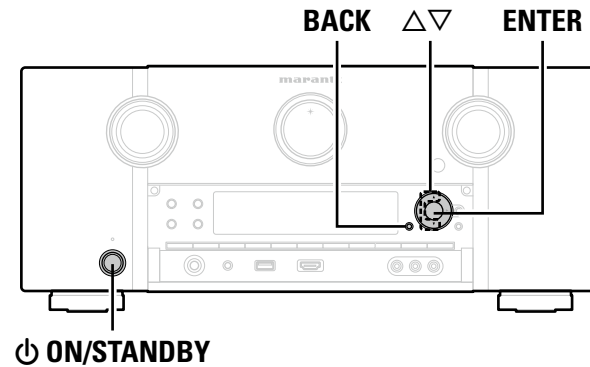

❑ Disabling the sensor function of the remote control unit

- 1** When the main unit is in standby mode, press **ON/STANDBY** while holding down **BACK** and **ENTER** on the main unit.
- 2** Press **△▽** to select “RC LOCK On”.
- 3** Press **ENTER** to enter the setting.
The infrared light receiving function is disabled.

❑ Enabling the remote sensor function

- 1** When the main unit is in standby mode, press **ON/STANDBY** while holding down **BACK** and **ENTER** on the main unit.
- 2** Press **△▽** to select “RC LOCK *Off”.
(* The currently set mode.)
- 3** Press **ENTER** to enter the setting.
The infrared light receiving function on the main unit is enabled.

Switches light illumination on/off

- You can switch the lighting around the main display on or off.
- The factory setting is "ON".

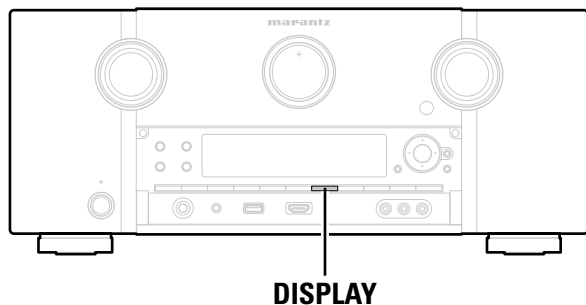

Press and hold DISPLAY on the main unit for 3 seconds.

- Carry out the same procedure if you want to change the settings again.

Various memory functions

Personal memory plus function

This function sets the settings (input mode, sound mode, HDMI output mode, MultEQ® XT, Dynamic EQ, audio delay etc.) last selected for the individual input sources.



The surround parameters, tone settings and the volumes of the different speakers are stored for the individual sound modes.

Last function memory

This function stores the settings which were made before going into the standby mode. When the power is turned back on, the settings are restored.

Playback in ZONE2/ZONE3 (Separate room)

- You can operate this unit so as to enjoy audio in a room (ZONE2, ZONE3) other than the MAIN ZONE (room where the unit is located).
- You can simultaneously play back the same source in both the MAIN ZONE, ZONE2 and ZONE3. You can also play back separate sources in the MAIN ZONE, ZONE2 and ZONE3.
- When a TV is connected to the HDMI ZONE2 OUT connector, you can play back a video or audio from the device connected to the HDMI 1 - 6 IN connector in ZONE2 (**HDMI ZONE2 function**).



The source selected for ZONE2 is also output from the recording output connectors (MEDIA PLAYER).

NOTE

The following restrictions apply to the HDMI ZONE2 function.

- If you select a same input source for MAIN ZONE and ZONE2, audio playback may be restricted or video may be interrupted.
- Video may not be output depending on the resolution of the TV used for MAIN ZONE and ZONE2. In this case, use your player to set the resolution of the TV.
- The HDMI audio signals for the input source selected in ZONE2 are output from the ZONE2 speakers.
- When HDMI ZONE2 function is used, you cannot set the following.
 - Picture Adjust
 - Auto Lip Sync
 - Video Mode
 - Video Conversion
 - i/p Scaler
 - Progressive Mode
 - Aspect Ratio
 - Setup menu display

Audio output

It is possible to play 2-channel audio in rooms other than the MAIN ZONE where multi-channel playback is done. Choose one of the methods.

- ① Zone playback by speaker output
- ② Zone playback by audio output (PRE OUT)
Use an external amplifier.

① Zone playback by speaker output

- Set the "Assign Mode" ([page 131](#)) setting to "ZONE2" or "ZONE3", and outputs ZONE2 or ZONE3 audio from SURROUND BACK speaker terminals (The default setting is "ZONE2").
- If you set the "Assign Mode" ([page 131](#)) setting to "ZONE2" or "ZONE3", the main zone home theater system can play back up to 5.1 channels. Even if you play back audio recorded in 6.1 or 7.1 channels, this unit automatically downmixes the audio to 5.1 channels.

Connecting and setting the speakers

	"Assign Mode" setting (page 131) and audio signals output	Connecting the speakers
ZONE2	<p>ZONE2 Output signal : Stereo (L / R)</p>	
ZONE3	<p>ZONE3 Output signal : Stereo (L / R)</p>	

② Zone playback by audio output (PRE OUT)

□ Audio connections (ZONE2, ZONE3)

The audio signals of this unit's ZONE2 and ZONE3 audio output terminals are output to the ZONE2 and ZONE3 amplifiers and played on these amplifiers.

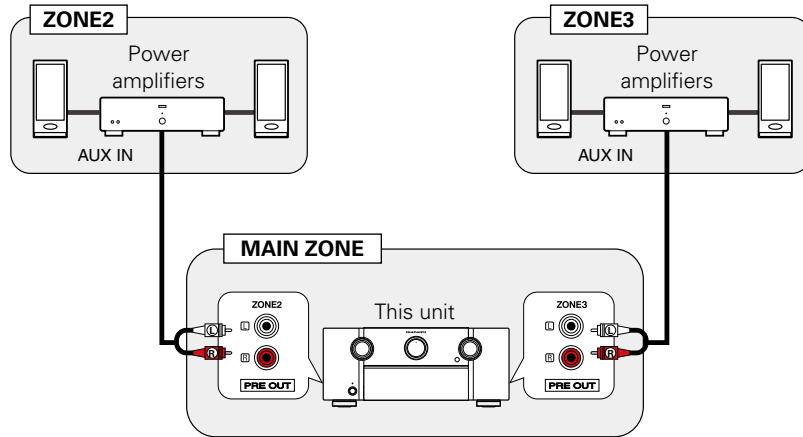

We recommend using high quality pin-plug cables for audio connections in order to prevent noise.

NOTE

In ZONE2 or ZONE3, the digital audio signals input from the HDMI, COAXIAL or OPTICAL connector cannot be played back. When playing back in ZONE2 or ZONE3, make an analog connection.

Video output

Video Connection

The video signals of this unit's ZONE2 video output connector are played by the ZONE2 TV.

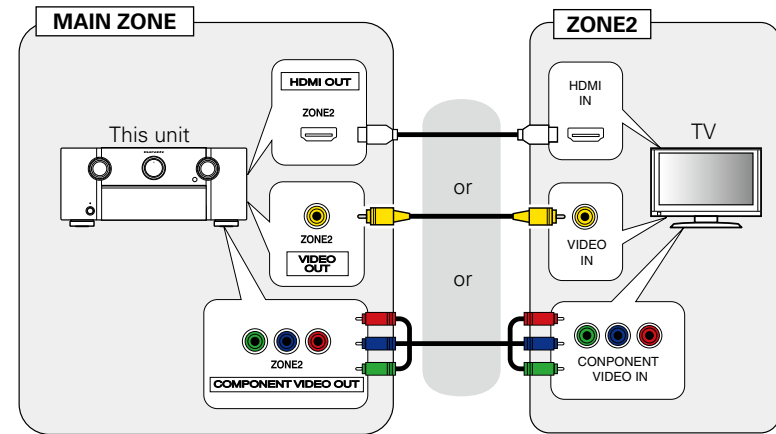

When "Component Video Out" ([page 123](#)) in the menu is set to "ZONE2", the component video output connector outputs the ZONE2 video.

NOTE

The menu screen is not output.

Playback

1 Press **ZONE SELECT** to switch “ZONE2” or “ZONE3”.

2 Press **ON/STANDBY** to turn on the ZONE2 or ZONE3 power.

- Also press input source select button when in standby mode, the power turns on.
- When **ON/STANDBY** is pressed, ZONE2 or ZONE3 turns off.
- Power in ZONE2 or ZONE3 can be turned on or off by pressing **ZONE2 ON/OFF** or **ZONE3 ON/OFF** on the main unit.

3 Press the input source select button to be played.

The audio signal of the selected source is output to ZONE2 or ZONE3.

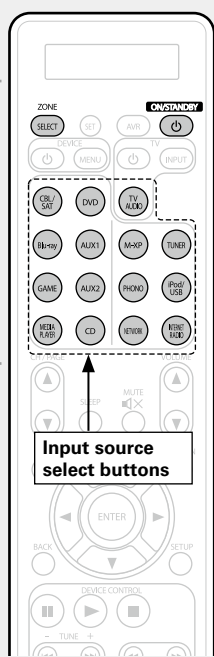

When power for both MAIN ZONE and ZONE2 is set to ON, power of the MAIN ZONE only can be turned off. In Step 1, press **ZONE SELECT** to select “MAIN” and then press **ON/STANDBY**.

Adjusting the volume

Use **VOLUME** to adjust the volume.



[Adjustable range] 0 – 40 – 98

(When the “Scale” (page 116) setting is “0 – 98”)

[Adjustable range] --- –79dB – –40dB – 18dB

(When the “Scale” (page 116) setting is “–79.5dB – 18.0dB”)

- At time of purchase, “Volume Limit” (page 140) is set to “70 (–10dB)”.



Turn **VOLUME** after pressing **ZONE2 ON/OFF** or **ZONE3 ON/OFF** on the main unit to adjust the sound volume.

Turning off the sound temporarily

Press **MUTE**.

The sound is reduced to the level set at “Mute Level” (page 140) in the menu.

- To cancel, either adjust the volume or press **MUTE** again.
- The setting can also be cancelled by adjusting the volume or turning off the ZONE2 or ZONE3 power.



You can adjust the tone and volume for ZONE2 or ZONE3 in “ZONE2 Setup” or “ZONE3 Setup” (page 140) in the menu.

Sleep timer function

- This is convenient for viewing and listening while going to sleep in ZONE2 or ZONE3.
- The sleep timer function can be set by zone.

1 Press **ZONE SELECT** to switch “ZONE2” or “ZONE3”.

2 Press **SLEEP** and display the time you want to set.

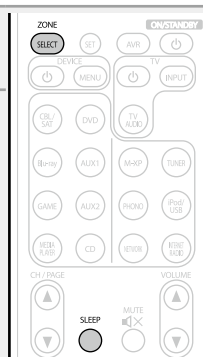

- The time switches as shown below each time **SLEEP** is pressed.

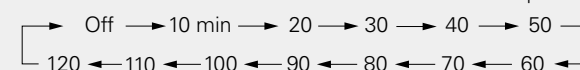

To confirm the countdown time before putting the unit to sleep

Press **SLEEP**.

“Z2 Sleep : *min” or “Z3 Sleep : *min” appears on the display.

* Countdown time

To cancel the sleep timer

Press **SLEEP** to set “Off”.



The sleep timer is also cancelled when this unit is set to the standby mode or the ZONE2 or ZONE3 power is turned off.

NOTE



The sleep timer function cannot turn off the power of devices connected to this unit. To turn off the power of those connected devices, set up sleep timers on the connected devices themselves.



How to make detailed settings



Menu map

For menu operation, connect a TV to this unit and display the menu on the TV screen. For menu operations, see the following page.

By default, this unit has recommended settings defined. You can customize this unit based on your existing system and your preferences.

Setting items	Detailed items	Description	Page
 Audio	Surround Parameter	Adjusts surround sound parameters.	113
	Tone	Adjusts the tonal quality of the sound.	114
	Dialogue Level	Sets the output level to clarify the dialogue output from the center channel.	114
	Subwoofer Level	Sets the subwoofer on/off and its output level.	115
	M-DAX	Expands the low and high frequency components of compressed audio to enable richer audio playback.	115
	Audio Delay	Compensates for incorrect timing between video and audio.	116
	Volume	Set the MAIN ZONE (room where the unit is located) volume setting.	116
	Audyssey	Makes Audyssey MultEQ® XT, Audyssey Dynamic EQ® and Audyssey Dynamic Volume® settings.	116
	Graphic EQ	Uses the graphic equalizer to adjust the tone of each speaker.	118
 Video	Picture Adjust	Adjusts the video quality.	120
	HDMI Setup	Makes settings for HDMI video/audio output.	120
	Output Settings	Makes screen-related settings.	122
	Component Video Out	Sets whether to use the component video output connector for MAIN ZONE or ZONE2.	123
	Volume Display	Sets where to display the master volume level.	123
	Info Display	Displays status of operation temporarily when the sound mode is changed, or input source is switched. You can set whether or not to show each of these status displays.	123
	Audio Display	Sets how long each menu is displayed when the input source is "NETWORK", "iPod/USB", or "HD Radio".	124
	TV Format	Set the video signal format to be output for the TV you are using.	124

Setting items	Detailed items	Description	Page
 Inputs	Input Assign	Changes input connector assignment.	126
	Source Rename	Changes the display name for this source.	127
	Hide Sources	Remove from the display input sources that are not used.	128
	Source Level	Adjusts the playback level of the audio input.	128
	Input Select	Sets the audio input mode and decode mode.	128
	Video Source	Video of another input source is played back combined with the playing audio.	129
 Speakers	Audyssey® Setup	The acoustic characteristics of the connected speakers and listening room are measured and the optimum settings are made automatically.	29 , 91
	Manual Setup	Perform when setting the speakers manually or when changing settings made in Audyssey® Setup.	131
 Network	Information	Display network information.	136
	IP Control	Set the network function on/off during standby.	136
	Friendly Name	The Friendly Name is the name of this unit displayed on the network. You can change the Friendly Name according to your preferences.	136
	Settings	Make settings for wired LAN.	137
	Maintenance Mode	Use when receiving maintenance from a marantz service engineer or custom installer.	138

Setting items	Detailed items	Description	Page
 General	Language	Sets the language for display the menu on the TV screen.	140
	ZONE2 Setup	Makes settings for audio playback in a ZONE2 system.	140
	ZONE3 Setup	Makes settings for audio playback in a ZONE3 system.	140
	Zone Rename	Change the display title of each zone to one you prefer.	141
	Trigger Out 1	Selects when to activate trigger out 1.	141
	Trigger Out 2	Selects when to activate trigger out 2.	141
	Auto Standby	When you do not perform any operation on this unit with no audio or video input for a specified time, this unit automatically enters the standby mode. Before it enters the standby mode, "Auto Standby" is displayed on the display of this unit and the menu screen.	141
	Front Display	Makes settings related to the display on this unit.	141
	Information	Show information about receiver settings, input signals, etc.	142
	Firmware	Set whether or not to check for firmware update, update the firmware, and display update and upgrade notifications.	143
Setup Lock	Protect settings from inadvertent change.	144	
 Setup Assistant	Perform the installation, connection, and setup procedures to prepare the unit for operation following guidance.		 7

Examples of menu screen displays

Typical examples are described below.

[Example 1]

Menu selection screen (Top menu)

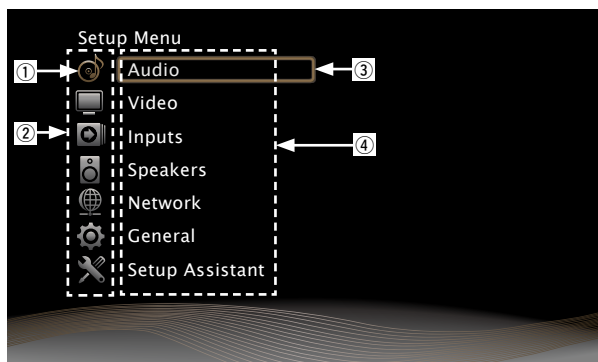

- ① Currently selected setup icon
- ② List of GUI menu setup icons
- ③ Currently selected setup item
- ④ List of GUI menu setup items

Use Δ / ∇ to select "Audio"
and then press \triangleright .
(Or press ENTER.)

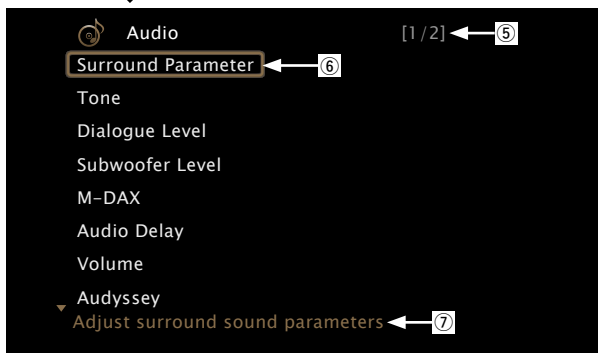
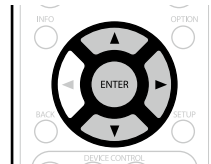

- ⑤ Indication of there being following pages
- ⑥ Selected setup item
- ⑦ Guide text for the currently selected setup item

[Example 2]

Audyssey® Setup screen (with illustration)

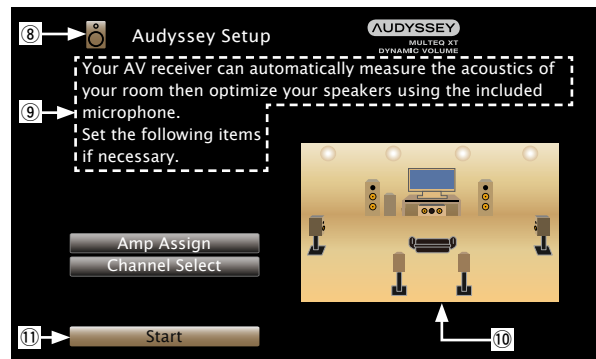







- ⑧ Currently selected setup icon
- ⑨ Operation guidance text
- ⑩ Illustration
- ⑪ Selected setup item

NOTE

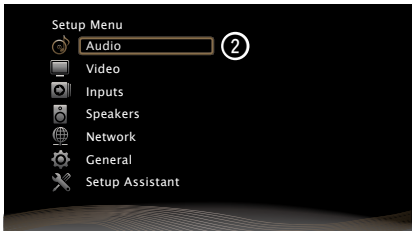
When the menu is operated on a computer's resolution (e.g. VGA) or during playback of certain 3D video content, the playback image switches to the menu screen image.

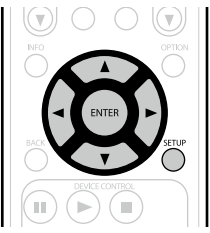
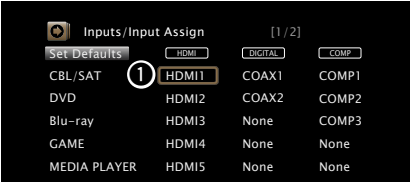
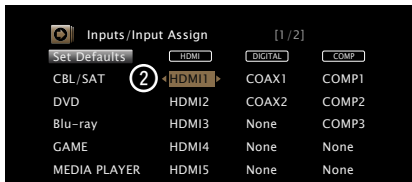
Examples of menu and front display

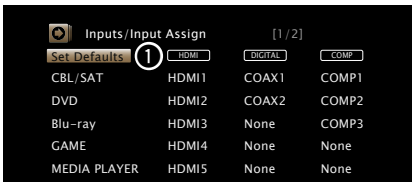
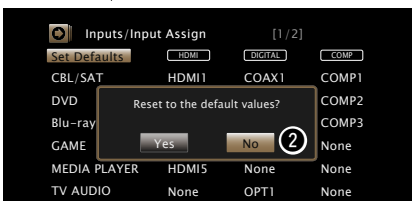
Below we describe typical examples of displays on the TV screen and on the set's display window.

	Menu display	Front display	Description
Top menu display			<ol style="list-style-type: none"> 1 Press SETUP to display the menu screen. 2 TV screen: Displays the selected line. Display: Displays the selected item. <ul style="list-style-type: none"> • Use Δ/∇ to move to the item you want to set. 
Display when changing settings	 <p>Press ENTER.</p> 	 <p>Press ENTER.</p> 	<ol style="list-style-type: none"> 1 TV screen: Displays the selected line. Display: Displays the selected item. 2 Press ENTER to set to the mode in which the setting can be made. <ul style="list-style-type: none"> • Use Δ/∇ to move to the item you want to set. <p>3 \blacktriangleleft \blacktriangleright is displayed at the sides of items whose setting can be changed. Use \blacktriangleleft/\blacktriangleright to change to the desired setting.</p>
Display when returning to the settings in effect at time of purchase	 <p>Press ENTER.</p> 	 <p>Press ENTER.</p> 	<ol style="list-style-type: none"> 1 Press Δ to select "Set Defaults", then press ENTER. 2 Press \blacktriangleleft to select "Yes", then press ENTER.

Inputting characters

On this unit, you can change the name displayed on the following screens to the names that you prefer.

- Text Search (page 69)
- Preset Name (page 51)
- Source Rename (page 127)
- Friendly Name (page 136)
- Zone Rename (page 141)
- Character input for the network functions (page 54, 62, 64, 67, 138)

Keyboard screen

Select a character on the TV screen to input characters.

Display of a keyboard input screen

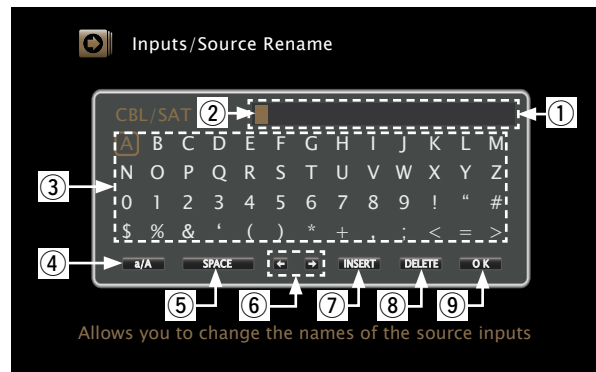

- ① Character input section
- ② Cursor
- ③ Keyboard section
- ④ Uppercase and lowercase switch key
- ⑤ Space key
- ⑥ Cursor keys
- ⑦ Insert key
- ⑧ Delete key
- ⑨ OK key

Input method

1 Display the screen for inputting characters (page 107 “Menu map”).

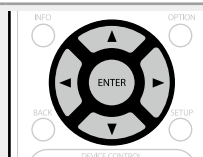

2 Select a character to be changed.

① Use $\Delta \nabla \triangleleft \triangleright$ to select \blackleftarrow or \blackrightarrow .

② Press **ENTER** to place the cursor at the character to be changed.

Each time **ENTER** is pressed, the cursor moves by one character.

3 Select a character to be input with $\Delta \nabla \triangleleft \triangleright$ then press **ENTER**.

- The types of characters that can be input are as shown below.

[Upper case characters/Numbers/Symbols]

ABCDEFGHIJKLMNOPQRSTUVWXYZ

0123456789

! " # \$ % & ' () * + , ; = >

[Lower case characters/Numbers/Symbols]

abcdefghijklmnopqrstuvwxyz

0123456789

. @ _ / : ~ ? [\] ^ ' { | }

- When you use $\Delta \nabla$ while you type in, you can change uppercase characters to lowercase and vice versa.

4 Repeat steps 2 and 3 to change the name.

5 Use $\Delta \nabla \triangleleft \triangleright$ to select **OK**, then press **ENTER**.



Make audio-related settings.

Menu operation

- 1** Press **ZONE SELECT** to switch “MAIN”.
 - 2** Press **SETUP**.
The menu is displayed on the TV screen.
 - 3** Use Δ / ∇ to select the menu to be set or operated.
 - 4** Press **ENTER** or \triangleright to enter the setting.
- To return to the previous item, press \triangleleft or **BACK**.
 - Exiting the Menu, press **SETUP** while the menu is displayed.
The menu display disappears.

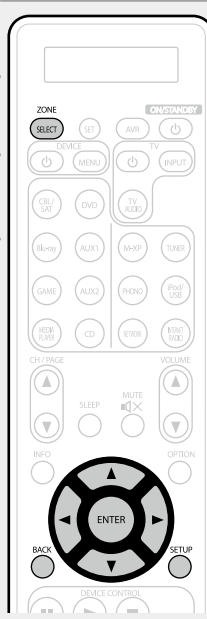

Items that can be set with the “Audio” procedure

Surround Parameter ([page 113](#))

Tone ([page 114](#))

Dialogue Level ([page 114](#))

Subwoofer Level ([page 115](#))

M-DAX ([page 115](#))

Audio Delay ([page 116](#))

Volume ([page 116](#))

Audyssey ([page 116](#))

Graphic EQ ([page 118](#))

Surround Parameter



Default settings are underlined.



You can adjust the surround audio sound field effects to match your preferences. The items (parameters) that can be adjusted depend on the signal being input and the currently set sound mode. For details on the adjustable parameters, see “Sound modes and surround parameters” ([page 163](#)).

NOTE

- Some setting items cannot be set while playback is stopped. Make the settings during playback.
- When the sound mode is “PURE DIRECT”, you cannot set the surround parameters.

Setting items	Setting details
Home Theater EQ Softens the treble range of movie soundtracks for better understanding.	On : “Home Theater EQ” is used. Off : “Home Theater EQ” is not used.
Loudness Management This can be set in the Dolby TrueHD mode. This sets whether to output as specified in “Dynamic Compression” or output directly without compressing the dynamic range of audio recorded in the disc.	On : Outputs using the settings made in “Dynamic Compression”. Off : “Dynamic Compression” settings and “Dialogue normalization” (page 142) are disabled, and the signals on the disk are output as is.
Dynamic Compression Compress dynamic range (difference between loud and soft sounds).	Auto : Automatic dynamic range compression on/off control according to source. Low / Medium / High : These set the compression level. Off : Dynamic range compression always off.  You can set “Auto” only for the Dolby TrueHD source.

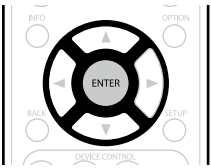

Setting items	Setting details
Low Frequency Effects Adjust the low-frequency effects level (LFE).	<input type="checkbox"/> When “Input Mode” (page 128) is set other than to “7.1CH IN” –10dB – <u>0dB</u> <input type="checkbox"/> When “Input Mode” (page 128) is set to “7.1CH IN” <u>0dB / +5dB / +10dB / +15dB</u>  For proper playback of the different sources, we recommend setting to the values below. <ul style="list-style-type: none"> • Dolby Digital sources : “0dB” • DTS movie sources : “0dB” • DTS music sources : “–10dB”
Center Image Distributes the dialogue output from the center channel to the front left and right channels and widens the sound image in the front. You can set this when the sound mode is set to DTS NEO:6 in the “Music” mode.	0.0 – 1.0 (0.3)  The smaller the value, the more dialogue is concentrated on the center channel. The larger the value, the more dialogue is distributed to front left and right channels, and the more the sound image widens in the front.
Panorama Assign front L/R signal also to surround channels for wider sound. You can set this when the sound mode is Dolby PLII in the “Music” mode.	On : Set. Off : Do not set.
Dimension Shift sound image center to front or rear to adjust playback balance. You can set this when the sound mode is Dolby PLII in the “Music” mode.	0 – 6 (3)  As you set a smaller number, the surround sound field shifts backward; as you set a larger number, the surround sound field shifts forward.

Setting items	Setting details
<p>Center Width Distributes the dialogue output from the center channel to left and right channels and widens the sound image in the front. You can set this when the sound mode is Dolby PLIIx in the "Music" mode.</p>	<p>0 – 7 (3)</p> <p> The smaller the value, the more dialogue is concentrated on the center channel. The larger the value, the more dialogue is distributed to front left and right channels, and the more the sound image widens in the front.</p>
<p>Height Gain Control the front height channel volume.</p>	<p>Low : Reduce the front height channel volume. Normal : Front height channel sound is output with standard sound volume. High : Increase the front height channel volume.</p> <p>NOTE</p> <p>"Height Gain" is displayed for the following settings.</p> <ul style="list-style-type: none"> • When "Assign Mode" (page 131) is set to "Main Only". • When the "Speaker Config." – "Front Height" setting (page 132) is set other than to "None". • When sound mode is "PLIIz" or the PLIIz decoder is used.
<p>Speaker Select Make settings for the speakers outputting sound when playing back in original surround mode.</p>	<p>Surround Back : Sound is output from the surround back speakers. Height : Sound is output from the front height speakers. Wide : Sound is output from the front wide speakers. Off : Sound is not output from the surround back speakers, front wide speakers and front height speakers.</p> <p>NOTE</p> <p>Only speakers that are set to something other than "None" in "Speaker Config." (page 131) can be selected.</p>
<p>Set Defaults The "Surround Parameter" settings are returned to the default settings.</p>	<p>Yes : Reset to the defaults. No : Do not reset to the defaults.</p> <p> When you select "Set Defaults" and press ENTER, the "Reset to the default values?" prompt is displayed. Select either "Yes" or "No", and press ENTER.</p> 

Tone

Default settings are underlined.

Adjust the tonal quality of the sound.

Setting items	Setting details
<p>Tone Control Set the tone control function to "On" and "Off".</p>	<p>On : Allow tone adjustment (bass, treble). Off : Playback without tone adjustment.</p> <p> "Tone Control" can be set when "Dynamic EQ" (page 117) is set to "Off".</p> <p>NOTE</p> <ul style="list-style-type: none"> • "Tone Control" settings are not reflected to ZONE2 and ZONE3. • The tone cannot be adjusted in the "DIRECT" or "PURE DIRECT" mode.
<p>Bass Adjust bass.</p>	<p>-6dB – +6dB (0dB)</p> <p> "Bass" can be set when the menu "Tone Control" setting is "On".</p>
<p>Treble Adjust treble.</p>	<p>-6dB – +6dB (0dB)</p> <p> "Treble" can be set when the menu "Tone Control" setting is "On".</p>

Dialogue Level

Default settings are underlined.

Sets the output level to clarify the dialogue output from the center channel.

Setting items	Setting details
<p>Dialogue</p>	<p>-12.0dB – +12.0dB (0dB)</p>

Subwoofer Level

Default settings are underlined.

Sets the subwoofer on/off and its output level.

Setting items	Setting details
Subwoofer Turn subwoofer output on and off.	On : The subwoofer is used. Off : The subwoofer is not used. <div style="background-color: #f08080; border-radius: 10px; padding: 2px; display: inline-block;">NOTE</div> This can be set when the sound mode is "DIRECT" or "PURE DIRECT" (page 75) and the "Subwoofer Mode" (page 132) is "LFE+Main".
Subwoofer Level Set the subwoofer output level.	-12.0dB – +12.0dB (0dB)

M-DAX

Default settings are underlined.

Compressed audio formats such as MP3, WMA (Windows Media Audio) and MPEG-4 AAC reduce the amount of data by eliminating signal components that are hard for the human ear to hear. The M-DAX function generates the signals eliminated upon compression, restoring the sound to conditions near those of the original sound before compression. It also corrects the sense of volume of the bass to obtain richer sound with compressed audio signals.

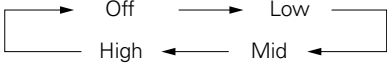
Setting items	Setting details
Mode Set the mode for M-DAX.	Off : Do not use M-DAX. Low : Optimized mode for compressed sources with normal highs. Mid : Apply suitable bass and treble boost for all compressed sources. High : Optimized mode for compressed sources with very weak highs.  <ul style="list-style-type: none"> This item can be set with analog signals or PCM signal (Sample rate = 44.1/48 kHz) is input. "M-DAX" settings are stored for each input source. When set to "Off", the M-DAX indicator on the front panel switches off. This cannot be set when the surround mode is set to "DIRECT" or "PURE DIRECT". This can also be set by pressing M-DAX on the main unit. Each time M-DAX is pressed, the setting is changed as shown below. <div style="text-align: center; margin-top: 10px;">  <pre> graph LR Off --> Low Low --> Mid Mid --> High High --> Off </pre> </div>

Audio Delay

Default settings are underlined.

While viewing video, manually adjust the time to delay audio output.

Setting details

0ms – 200ms



- This item can be set within the range of 0 to 100 ms when “Auto Lip Sync” ([page 120](#)) is set to “On” and when a TV compatible with Auto Lip Sync is connected.
- Store “Audio Delay” for each input source.
- Audio Delay for game mode can be set when “Video Mode” ([page 122](#)) is set to “Auto” or “Game”.

Volume

Default settings are underlined.

Set the MAIN ZONE (room where the unit is located) volume setting.

Setting items	Setting details
Scale Set how volume is displayed.	<p>0 – 98 : Display in the range 0 (Min) to 98. -79.5dB – 18.0dB : Display -dB (Min), in the range -79.5 dB to 18.0 dB.</p>  <ul style="list-style-type: none"> • The “Scale” setting is applied also to the “Limit” and “Power On Level” display method. • The “Scale” setting applies to all zones.
Limit Make a setting for maximum volume.	<p>Off : Do not set a maximum volume. 60 (-20dB) / 70 (-10dB) / 80 (0dB)</p>
Power On Level Define the volume setting that is active when the power is turned on.	<p>Last : Use the memorized setting from the last session. Mute : Always use the muting on condition when power is turned on. 1 – 98 (-79dB – 18dB) : The volume is adjusted to the set level.</p>
Mute Level Set the amount of attenuation when muting is on.	<p>Full : The sound is muted entirely. -40dB : The sound is attenuated by 40 dB down. -20dB : The sound is attenuated by 20 dB down.</p>

Audyssey

Default settings are underlined.

Set Audyssey MultEQ® XT, Audyssey Dynamic EQ® and Audyssey Dynamic Volume®. These can be selected after Audyssey® Setup has been performed. For additional information on Audyssey technology, please see [page 171](#).



NOTE



- If you have not performed Audyssey® Setup, or if you change the speaker settings after performing Audyssey® Setup, you may not be able to select Dynamic EQ/Dynamic Volume. In this case, either perform Audyssey® Setup over again or perform “Restore...” ([page 35](#)) to return to the settings after Audyssey® Setup was run.
- When HD Audio for which the sampling frequency exceeds 96 kHz is played back, the “Audyssey” cannot be set.

Setting items	Setting details
MultEQ® XT MultEQ® XT compensates for both time and frequency characteristics of the listening area based on “Audyssey® Setup” measurement results. Selection is done from three types of compensation curves. We recommend the “Audyssey” setting. MultEQ® XT is the prerequisite function for Dynamic EQ and Dynamic Volume.	<p>Audyssey : Optimize the frequency response of all speakers. Audyssey Byp. L/R : Optimize frequency response of speakers except front L and R speakers. Audyssey Flat : Optimize frequency response of all speakers to flat response. Graphic EQ : Apply frequency response set with “Graphic EQ” (page 118). Off : Turn “MultEQ® XT” equalizer off.</p>  <ul style="list-style-type: none"> • “Audyssey”, “Audyssey Byp. L/R” and “Audyssey Flat” can be selected after “Audyssey® Setup” has been performed. “Audyssey” is automatically selected after performing “Audyssey® Setup”. When “Audyssey”, “Audyssey Byp. L/R” or “Audyssey Flat” is selected, AUDYSSEY illuminates. • After running “Audyssey® Setup”, if the Speaker Configuration, Distance, Channel Level, and Crossover Frequency have changed without increasing the number of speakers measured, only AUDYSSEY illuminates. <p>NOTE When using headphones, “MultEQ® XT” is automatically set to “Off”.</p>

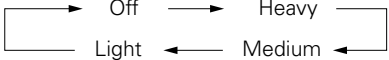

“MultEQ® XT”, “Dynamic EQ” and “Dynamic Volume” settings are stored for each input source.

Setting items	Setting details
<p>Dynamic EQ Solve the problem of deteriorating sound quality as volume is decreased by taking into account human perception and room acoustics. Works with MultEQ® XT.</p>	<p>On : Use Dynamic EQ. Off : Do not use Dynamic EQ.</p>  <ul style="list-style-type: none"> • AUDYSSEY is displayed when set to "On". • This can also be set by pressing DYNAMIC EQ on the main unit. Each time DYNAMIC EQ is pressed, the setting is changed as shown below. <p style="text-align: center;">On ← → Off</p> <p>NOTE When the menu "Dynamic EQ" setting is "On", it is not possible to do "Tone Control" (page 114) adjustment.</p>
<p>Reference Level Offset Audyssey Dynamic EQ® is referenced to the standard film mix level. It makes adjustments to maintain the reference response and surround envelopment when the volume is turned down from 0 dB. However, film reference level is not always used in music or other non-film content. Dynamic EQ Reference Level Offset provides three offsets from the film level reference (5 dB, 10 dB, and 15 dB) that can be selected when the mix level of the content is not within the standard. Recommended setting levels are shown at right.</p>	<p>0dB (Film Ref) : This is the default setting and should be used when listening to movies. 5dB : Select this setting for content that has a very wide dynamic range, such as classical music. 10dB : Select this setting for jazz or other music that has a wider dynamic range. This setting should also be selected for TV content as that is usually mixed at 10 dB below film reference. 15dB : Select this setting for pop/rock music or other program material that is mixed at very high listening levels and has a compressed dynamic range.</p> <p> Setting is enabled when "Dynamic EQ" is "On" (page 117).</p>

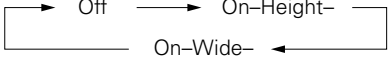
Setting items	Setting details
<p>Dynamic Volume Solve the problem of large variations in volume level between TV, movies and other content (between quiet passages and loud passages, etc.) by automatically adjusting to the user's preferred volume setting.</p>	<p>Heavy : Most adjustment to softest and loudest sounds. Medium : Medium adjustment to loudest and softest sound. Light : Least adjustment to loudest and softest sounds. Off : Do not use "Dynamic Volume".</p>  <ul style="list-style-type: none"> • AUDYSSEY is displayed when set to "Heavy", "Medium" or "Light". • If "Dynamic Volume" is set to "Yes" in "Audyssey® Setup" (page 33), the setting is automatically changed to "Medium". • This can also be set by pressing DYNAMIC VOL on the main unit. Each time DYNAMIC VOL is pressed, the setting is changed as shown below. <p style="text-align: center;">  </p>
<p>Audyssey DSX® Provides more immersive surround sound by adding the new channels.</p>	<p>On-Height- : Turn on A-DSX processing for height expansion. On-Wide- : Turn on A-DSX processing for wide expansion. Off : Do not set Audyssey DSX®.</p> <p> This can also be set by pressing A-DSX on the main unit. Each time A-DSX is pressed, the setting is changed as shown below.</p> <p style="text-align: center;">  </p> <p>NOTE "Audyssey DSX®" cannot be configured if the HD Audio source being played includes Front height and Front wide channels. In this case, the respective channels are played back using the input signals.</p>



Setting items	Setting details
Stage Height Adjust sound stage height when using front height speakers.	-10 – +10 (0)  <ul style="list-style-type: none"> • “Audyssey DSX®” can be set when you are using front height speakers or front wide speakers. • “Audyssey DSX®” is only valid when using a center speaker. • “Audyssey DSX®” is valid when surround mode is DOLBY listening mode or DTS listening mode other than PLIIz Height. <div style="border: 1px solid black; padding: 5px;"> <p>About Audyssey Dynamic Surround Expansion (A-DSX)</p> <p>Audyssey DSX® is a scalable system that adds new speakers to improve surround impression. Starting with a 5.1 system Audyssey DSX® first adds Wide channels for the biggest impact on envelopment. Research in human hearing has proven that information from the Wide channels is much more critical in the presentation of a realistic soundstage than the Back Surround channels found in traditional 7.1 systems. Audyssey DSX® then creates a pair of Height channels to reproduce the next most important acoustical and perceptual cues. In addition to these new Wide and Height channels, Audyssey DSX® applies Surround Envelopment Processing to enhance the blend between the front and surround channels.</p> </div>
Stage Width Adjust sound stage width when using front wide speakers.	-10 – +10 (0)

Graphic EQ

Default settings are underlined.

Use the graphic equalizer to adjust the tone of each speaker.

“Graphic EQ” can be set when “MultEQ® XT” setting ([page 116](#)) is “Graphic EQ”.

Setting items	Setting details
Speaker Selection Select whether to adjust tones for individual speakers or for all speakers.	All : Adjust the tone of all speakers together. Left/Right : Adjust the tone of left and right speakers together. Each : Adjust the tone of each speaker.
Adjust EQ Adjust tones for each frequency band. Adjust the speaker selected in “Speaker Selection”.	① Select the speaker. ② Select the adjustment frequency band. 63Hz / 125Hz / 250Hz / 500Hz / 1kHz / 2kHz / 4kHz / 8kHz / 16kHz <ul style="list-style-type: none"> • Select the speakers you want to adjust when “Left/Right” or “Each” is selected. ③ Adjust the level. -20.0dB – +6.0dB (0.0dB)
Curve Copy Copy “Audyssey Flat” (page 116) curve from MultEQ® XT.	Yes : Copy. No : Do not copy.  <ul style="list-style-type: none"> • “Curve Copy” is displayed after “Audyssey® Setup” has been performed. • When you select “Curve Copy” and press ENTER, the “Copy “Audyssey Flat”?” prompt is displayed. Select either “Yes” or “No”, and press ENTER.
Set Defaults The “Graphic EQ” settings are returned to the default settings.	Yes : Reset to the defaults. No : Do not reset to the defaults.  When you select “Set Defaults” and press ENTER , the “Reset to the default values?” prompt is displayed. Select either “Yes” or “No”, and press ENTER .

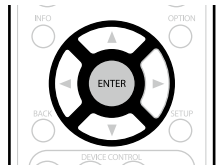



Make video-related settings.

NOTE

When HDMI ZONE2 function is used, these settings are not available.

Menu operation

1 Press **ZONE SELECT** to switch “MAIN”.

2 Press **SETUP**.
The menu is displayed on the TV screen.

3 Use Δ ∇ to select the menu to be set or operated.

4 Press **ENTER** or \blacktriangleright to enter the setting.

- To return to the previous item, press \blacktriangleleft or **BACK**.
- Exiting the Menu, press **SETUP** while the menu is displayed.
The menu display disappears.



Items that can be set with the “Video” procedure

Picture Adjust ([page 120](#))

HDMI Setup ([page 120](#))

Output Settings ([page 122](#))

Component Video Out ([page 123](#))

Volume Display ([page 123](#))

Info Display ([page 123](#))

Audio Display ([page 124](#))

TV Format ([page 124](#))

Picture Adjust

Default settings are underlined.

Picture quality can be adjusted.

We recommend leaving the settings unchanged from the default settings. First adjust the display image quality on your TV, and use this menu only when you want to make fine adjustments.

- This item can be set when the input source is **CBL/SAT** **DVD** **Blu-ray** **GAME** **AUX1** **AUX2** **MEDIA PLAYER** **CD** **NETWORK** **TV AUDIO**.
- With input sources other than the ones above, this item can be set when "Video Select" is selected. In this case, the original input source settings are called out.
- Can be set when the "Video Conversion" setting ([page 122](#)) is "On".
- "Blu-ray", "GAME", "AUX2", "TV AUDIO" or "CD" can be set when "HDMI" or "COMP" ([page 126, 127](#)) has been assigned.

Setting items	Setting details
Contrast Adjust picture contrast.	-6 - +6 (0)
Brightness Adjust picture brightness.	0 - +12
Saturation Adjust picture chroma level (saturation).	-6 - +6 (0)
Hue Adjust green and red balance.	-6 - +6 (0)
Noise Reduction Reduce overall video noise.	Off / Low / Medium / High
Enhancer Emphasize picture contours.	0 - +12





- "Picture Adjust" can not be set when video and component video signals are output.
- "Picture Adjust" can not be set when 4K signals are input.





HDMI Setup

Default settings are underlined.

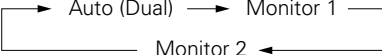
Make settings for HDMI video/audio output.

Setting items	Setting details
Auto Lip Sync Make automatic compensation for timing shift in audio and video output.	On : Compensated. Off : Not compensated.
HDMI Audio Out Select HDMI audio output device.	AVR : Play back through speakers connected to the unit. TV : Play back through TV connected to the unit.  <ul style="list-style-type: none"> The audio signal input from the HDMI input connector can be output as an output signal from the HDMI output connector by setting the HDMI audio output destination to TV. Audio signals input via the Analog/Coaxial/Optical input connectors cannot be output from the HDMI output connector. When the HDMI control function is activated, priority is given to the TV audio setting (page 96 "HDMI control function").

Setting items	Setting details
Video Output Make settings for HDMI monitor output.	<p>Auto (Dual) : The presence of a TV connected to the HDMI MONITOR 1 or HDMI MONITOR 2 connector is detected automatically, and that TV connection is used.</p> <p>Monitor 1 : A TV connected to the HDMI MONITOR 1 connector is always used. Video is not output from the TV connected to the HDMI MONITOR 2 connector.</p> <p>Monitor 2 : A TV connected to the HDMI MONITOR 2 connector is always used. Video is not output from the TV connected to the HDMI MONITOR 1 connector.</p> <p></p> <ul style="list-style-type: none"> • If both the HDMI MONITOR 1 and HDMI MONITOR 2 connectors are connected and "Resolution" (page 122) is set to "Auto", the signals are output with a resolution compatible with both TV. • With "Resolution" (page 122) not set to "Auto", check whether the TV you are using is compatible with the resolution under "Video" – "Monitor" (page 142). • This can also be set by pressing HDMI OUT on the main unit. Each time HDMI OUT is pressed, the setting is changed as shown below. <div style="text-align: center;">  <pre> graph LR A[Auto (Dual)] --> B[Monitor 1] B --> C[Monitor 2] C --> A </pre> </div> <p>NOTE</p> <p>Depending on the monitor you have connected, the display may not be correct when you set to "Auto (Dual)". In such a case, set to either "Monitor 1" or "Monitor 2".</p>

Setting items	Setting details
HDMI Control You can link operations with devices connected to HDMI and compatible with HDMI Control.	<p>On : Use HDMI control function.</p> <p>Off : Do not use HDMI control function.</p> <p></p> <ul style="list-style-type: none"> • When a device that is not compatible with the HDMI control function is connected, set "HDMI Control" to "Off". • Please consult the operating instructions for each connected device to check the settings. • Refer to "HDMI control function" (page 96) for more information about the HDMI control function. <p>NOTE</p> <ul style="list-style-type: none"> • When "HDMI Control" is set to "On", it consumes more standby power. If you are not using this unit for an extended period, it is recommended that you unplug the power cord from the power outlet. • The HDMI control function controls operations of a TV that is compatible with the HDMI control function. Make sure that the TV and HDMI are connected when you perform HDMI control. • If the "HDMI Control" settings have been changed, always reset the power to connected devices after the change.
Standby Source Sets the HDMI input source to put into standby when the power is on.	<p>Last : Enters standby with the previously used input source.</p> <p>CBL/SAT / DVD / Blu-ray / GAME / AUX1 / AUX2 / MEDIA PLAYER / CD : Enters standby with each of the input sources assigned to each input connector.</p> <p> "Standby Source" can be set when "HDMI Control" is set to "On".</p>
Control Monitor Set the HDMI MONITOR terminal to output the HDMI control signal.	<p></p> <p>Monitor 1 : Output from the HDMI MONITOR 1 connector.</p> <p>Monitor 2 : Output from the HDMI MONITOR 2 connector.</p> <ul style="list-style-type: none"> • "Control Monitor" can be set when "HDMI Control" is set to "On". • ARC function works only with the terminal selected by "Control Monitor".
Power Off Control Links the power standby of this unit to external devices.	<p>All : If power to a connected TV is turned off independently of the input source, power to this unit is automatically set to standby.</p> <p>Video : If power to a connected TV is turned off when the input source is CBL/SAT / DVD / Blu-ray / GAME / AUX1 / AUX2 / MEDIA PLAYER / CD, power to this unit is automatically set to standby.</p> <p>Off : This unit does not link with power to a TV.</p> <p> "Power Off Control" can be set when "HDMI Control" is set to "On".</p>

Output Settings

Default settings are underlined.

Makes screen-related settings.



* "Blu-ray", "GAME", "AUX2", "TV AUDIO" or "CD" can be set when "HDMI" or "COMP" (page 126, 127) has been assigned.



"Output Settings" can not be set when 4K signals are input.

Setting items	Setting details
Video Mode Make settings for video processing. <div style="display: flex; justify-content: space-between; margin-top: 5px;"> CBL/SAT DVD Blu-ray </div> <div style="display: flex; justify-content: space-between; margin-top: 5px;"> GAME AUX1 AUX2 </div> <div style="display: flex; justify-content: space-between; margin-top: 5px;"> MEDIA PLAYER CD </div> <div style="display: flex; justify-content: space-between; margin-top: 5px;"> TV AUDIO </div>	<p>Auto : Process video automatically based on the HDMI content information.</p> <p>Game : Always process video for game content.</p> <p>Movie : Always process video for movie content.</p> <p> <ul style="list-style-type: none"> If "Video Mode" is set to "Auto", the mode is switched according to the input contents. If a source is played in both MAIN ZONE (audio and video) and ZONE2 (audio only) modes in the same room, audio in MAIN ZONE and ZONE2 modes may sound out of synchronization, but this is not malfunction. In this case, setting to "Game" mode may improve audio synchronization. </p>
Video Conversion The input video signal is converted automatically in conjunction with the connected TV (page 6 "Converting input video signals for output (Video conversion function)"). <div style="display: flex; justify-content: space-between; margin-top: 5px;"> CBL/SAT DVD Blu-ray </div> <div style="display: flex; justify-content: space-between; margin-top: 5px;"> GAME AUX1 AUX2 </div> <div style="display: flex; justify-content: space-between; margin-top: 5px;"> MEDIA PLAYER CD </div> <div style="display: flex; justify-content: space-between; margin-top: 5px;"> TV AUDIO </div>	<p>On : The input video signal is converted.</p> <p>Off : The input video signal is not converted.</p> <p> <ul style="list-style-type: none"> When a non-standard video signal from a game machine or some other source is input, the video conversion function might not operate. In this case set "Video Conversion" to "Off". When "Video Conversion" is set to "Off", the video conversion function does not work. In this case, connect this unit and TV with the same type of cable. </p>

Setting items	Setting details
i/p Scaler Convert the input source resolution to the resolution set. <div style="display: flex; justify-content: space-between; margin-top: 5px;"> CBL/SAT DVD Blu-ray </div> <div style="display: flex; justify-content: space-between; margin-top: 5px;"> GAME AUX1 AUX2 </div> <div style="display: flex; justify-content: space-between; margin-top: 5px;"> MEDIA PLAYER CD </div> <div style="display: flex; justify-content: space-between; margin-top: 5px;"> NETWORK TV AUDIO </div>	<p>Analog : Use i/p scaler function for analog video signal.</p> <p>Analog & HDMI : Use i/p scaler function for analog and HDMI video signal.</p> <p>HDMI : Use i/p scaler function for HDMI video signal.</p> <p>Off : Do not use i/p scaler function.</p> <p> <ul style="list-style-type: none"> "Analog & HDMI" can be set for input sources for which an HDMI input connector is assigned. Which items can be set depend on the input source assigned to each input connector. This function is not effective when the input signal is "x.v.Color", 3D, sYCC 601 color, Adobe RGB color, Adobe YCC 601 color or computer resolution. </p>
Resolution Set the output resolution. You can set "Resolution" separately for HDMI output of the analog video input and HDMI input. <div style="display: flex; justify-content: space-between; margin-top: 5px;"> CBL/SAT DVD Blu-ray </div> <div style="display: flex; justify-content: space-between; margin-top: 5px;"> GAME AUX1 AUX2 </div> <div style="display: flex; justify-content: space-between; margin-top: 5px;"> MEDIA PLAYER CD </div> <div style="display: flex; justify-content: space-between; margin-top: 5px;"> NETWORK TV AUDIO </div>	<p>Auto : The number of pixels the TV connected to the HDMI MONITOR OUT connector supports is detected automatically and the appropriate output resolution is set.</p> <p>480p/576p / 1080i / 720p / 1080p / 1080p:24Hz / 4K : Set the output resolution.</p> <p> <ul style="list-style-type: none"> This item can be set when "i/p Scaler" is set to anything other than "Off". When "i/p Scaler" is set to "Analog & HDMI", the resolution of both the analog video input signal and HDMI input signal can be set. To watch 1080p/24Hz pictures, use a TV that supports 1080p/24Hz video signals. When set to "1080p:24Hz", you can enjoy film-like pictures for film sources (in 24 Hz). For video sources and mixed sources, we recommend setting the resolution to "1080p". It is not possible to convert a 50 Hz signal into 1080p/24Hz. It is output at a resolution of 1080p/50Hz. </p>

Setting items	Setting details
Progressive Mode Set an appropriate progressive conversion mode for the source video signal. CBL/SAT * DVD Blu-ray * GAME * AUX1 AUX2 * MEDIA PLAYER CD * TV AUDIO *	Auto : The video signal is automatically detected and the appropriate mode is set. Video : Select mode suitable for video playback. Video and Film : Select mode suitable for video and 30-frame film material playback.  This item can be set when "i/p Scaler" is set to anything other than "Off".
Aspect Ratio Set the aspect ratio for the video signals output to the HDMI. CBL/SAT * DVD Blu-ray * GAME * AUX1 AUX2 * MEDIA PLAYER CD * NETWORK TV AUDIO *	16:9 : Output at 16:9 aspect ratio. 4:3 : Output at 4:3 aspect ratio.  "Aspect Ratio" can be set when "i/p Scaler" is set to anything other than "Off".

* "Blu-ray", "GAME", "AUX2", "TV AUDIO" or "CD" can be set when "HDMI" or "COMP" ([page 126, 127](#)) has been assigned.

Component Video Out

Default settings are underlined.

Sets the zone to which the component video output connector is assigned.

Setting items	Setting details
Component	<u>MAIN_ZONE</u> : Assigns the component video output connector to MAIN_ZONE. ZONE2 : Assigns the component video output connector to ZONE2.

Volume Display

Default settings are underlined.

Sets where to display the master volume level.

Setting items	Setting details
Volume	<u>Bottom</u> : Display at the bottom. Top : Display at the top. Off : Turn display off.  When the master volume display is hard to see when superimposed on movie subtitles, set to "Top".

Info Display

Default settings are underlined.

Displays status of operation temporarily when the sound mode is changed, or input source is switched. You can set whether or not to show each of these status displays.

Setting items	Setting details
On-screen Info	<u>On</u> : Turn display on. Off : Turn display off.

Audio Display

Default settings are underlined.



Sets how long each menu is displayed when the input source is "NETWORK", "iPod/USB", or "HD Radio".

Setting items	Setting details
Audio	<p><u>Always</u> : Show display continuously. <u>30s</u> : Show display for 30 seconds after operation. <u>10s</u> : Show display for 10 seconds after operation. Off : Turn display off.</p>

TV Format

Default settings are underlined.

Set the video signal format to be output for the TV you are using.

Setting items	Setting details
Format	<p><u>NTSC</u> : Select NTSC output. <u>PAL</u> : Select PAL output.</p> <p> "Format" can also be set by the following procedure. However, the menu screen is not displayed.</p> <ol style="list-style-type: none"> 1. Press and hold the main unit's STATUS and ZONE SELECT for at least 3 seconds. "V.Format : <NTSC>" appears on the display. 2. Use the main unit's   and set the video signal format. 3. Press the main unit's ENTER to complete the setting. <p>NOTE</p> <p>When a format other than the video format of the connected TV is set, the picture will not be displayed properly.</p>



Perform settings related to input source playback.

- You do not have to change the settings to use the unit. Make settings when needed.

Menu operation

1 Press **ZONE SELECT** to switch “MAIN”.

2 Press **SETUP**.
The menu is displayed on the TV screen.

3 Use Δ / ∇ to select the menu to be set or operated.

4 Press **ENTER** or \blacktriangleright to enter the setting.

- To return to the previous item, press \blacktriangleleft or **BACK**.
- Exiting the Menu, press **SETUP** while the menu is displayed.
The menu display disappears.

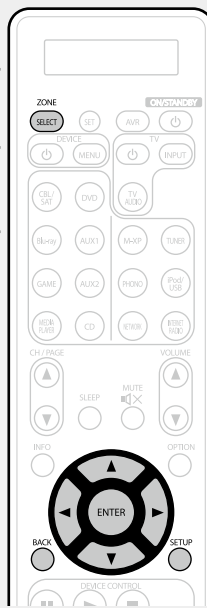

Items that can be set with the “Inputs” procedure

Input Assign ([page 126](#))

Source Rename ([page 127](#))

Hide Sources ([page 128](#))

Source Level ([page 128](#))

Input Select ([page 128](#))

Video Source ([page 129](#))

Important information

□ About the display of input sources

In this section, the configurable input sources for each item are shown as follows.



NOTE

Input sources that have been set to “Hide” at “Hide Sources” ([page 128](#)) cannot be selected.

Input Assign

This unit has certain input sources such as “CBL/SAT” assigned to audio and video connectors by default. By making the default connections, you can simply press an input source select button to play back audio or video from the connected device with ease.

When making connections other than the default settings, you must change settings in this section.

Examples of “Input Assign” menu screen displays

This screen appears when the “Inputs” – “each input source” – “Input Assign” menu is selected. Use the “Input Assign” menu to change the ② HDMI input connectors, ③ Digital input connectors, and ④ component input connectors that are assigned to the ① input sources in default settings.

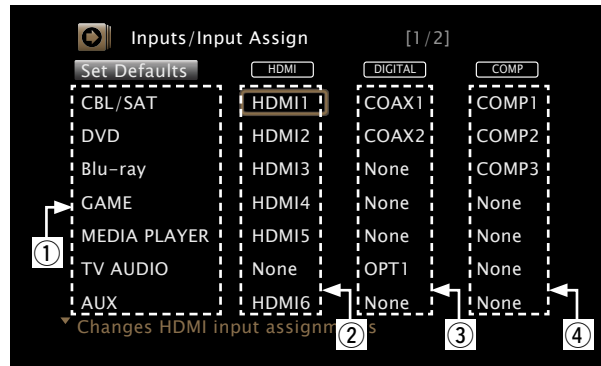

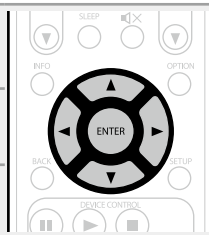

Input assignments menu operations

- 1** Use Δ ∇ \triangleleft \triangleright to move the cursor to the item you want to set, and then press **ENTER**.
- 2** Use \triangleleft \triangleright to select the input connector to be assigned.
- 3** Press **ENTER** to register the setting.



Setting items	Setting details					
HDMI Set this to change the HDMI input connectors assigned to the input sources.	HDMI 1 / HDMI 2 / HDMI 3 / HDMI 4 / HDMI 5 / HDMI 6 / HDMI 7 : Assign an HDMI input connector to the selected input source. None : Do not assign an HDMI input connector to the selected input source.					
CBL/SAT DVD	• At time of purchase, the settings of the different input sources are as shown below.					
Blu-ray GAME						
AUX1 AUX2						
MEDIA PLAYER CD						
TV AUDIO						
	Input source	CBL/SAT	DVD	Blu-ray	GAME	AUX1
	Default setting	HDMI 1	HDMI 2	HDMI 3	HDMI 4	HDMI 7
	Input source	AUX2	MEDIA PLAYER	CD	TV AUDIO	
	Default setting	HDMI 6	HDMI 5	None	None	
	<ul style="list-style-type: none"> • An input source to which an HDMI input connector cannot be assigned is displayed as “---”. • To play the video signal assigned at “HDMI” combined with the audio signal assigned at “Input Assign” – “DIGITAL”, select “Digital” at “Input Mode” (page 128). • The audio signals input from the analog and digital connectors are not output to the monitor. • When “HDMI Control” (page 121) is set to “On”, HDMI input connector cannot be assigned to “TV AUDIO”. 					

Setting items	Setting details																																
DIGITAL Set this to change the digital input connectors assigned to the input sources. <table border="1"> <tr> <td>CBL/SAT</td> <td>DVD</td> </tr> <tr> <td>Blu-ray</td> <td>GAME</td> </tr> <tr> <td>AUX1</td> <td>AUX2</td> </tr> <tr> <td>MEDIA PLAYER</td> <td>CD</td> </tr> <tr> <td>TV AUDIO</td> <td></td> </tr> </table>	CBL/SAT	DVD	Blu-ray	GAME	AUX1	AUX2	MEDIA PLAYER	CD	TV AUDIO		COAX 1 / COAX 2 / OPT 1 / OPT 2 : Assign a digital input connector to the selected input source. None : Do not assign a digital input connector to the selected input source. <ul style="list-style-type: none"> At time of purchase, the settings of the different input sources are as shown below. <table border="1"> <thead> <tr> <th>Input source</th> <th>CBL/SAT</th> <th>DVD</th> <th>Blu-ray</th> <th>GAME</th> <th>AUX1</th> </tr> </thead> <tbody> <tr> <td>Default setting</td> <td>COAX 1</td> <td>COAX 2</td> <td>None</td> <td>None</td> <td>None</td> </tr> </tbody> </table> <table border="1"> <thead> <tr> <th>Input source</th> <th>AUX2</th> <th>MEDIA PLAYER</th> <th>CD</th> <th>TV AUDIO</th> </tr> </thead> <tbody> <tr> <td>Default setting</td> <td>None</td> <td>None</td> <td>OPT 2</td> <td>OPT 1</td> </tr> </tbody> </table>	Input source	CBL/SAT	DVD	Blu-ray	GAME	AUX1	Default setting	COAX 1	COAX 2	None	None	None	Input source	AUX2	MEDIA PLAYER	CD	TV AUDIO	Default setting	None	None	OPT 2	OPT 1
CBL/SAT	DVD																																
Blu-ray	GAME																																
AUX1	AUX2																																
MEDIA PLAYER	CD																																
TV AUDIO																																	
Input source	CBL/SAT	DVD	Blu-ray	GAME	AUX1																												
Default setting	COAX 1	COAX 2	None	None	None																												
Input source	AUX2	MEDIA PLAYER	CD	TV AUDIO																													
Default setting	None	None	OPT 2	OPT 1																													
COMP (Component video) Set this to change the component video input connectors assigned to the input sources. <table border="1"> <tr> <td>CBL/SAT</td> <td>DVD</td> </tr> <tr> <td>Blu-ray</td> <td>GAME</td> </tr> <tr> <td>AUX1</td> <td>AUX2</td> </tr> <tr> <td>MEDIA PLAYER</td> <td>CD</td> </tr> <tr> <td>TV AUDIO</td> <td></td> </tr> </table>	CBL/SAT	DVD	Blu-ray	GAME	AUX1	AUX2	MEDIA PLAYER	CD	TV AUDIO		COMP 1 / COMP 2 / COMP 3 : Assign the component video input connector to the selected input source. None : Do not assign a component video input connector to the selected input source. <ul style="list-style-type: none"> At time of purchase, the settings of the different input sources are as shown below. <table border="1"> <thead> <tr> <th>Input source</th> <th>CBL/SAT</th> <th>DVD</th> <th>Blu-ray</th> <th>GAME</th> <th>AUX1</th> </tr> </thead> <tbody> <tr> <td>Default setting</td> <td>COMP 1</td> <td>COMP 2</td> <td>COMP 3</td> <td>None</td> <td>None</td> </tr> </tbody> </table> <table border="1"> <thead> <tr> <th>Input source</th> <th>AUX2</th> <th>MEDIA PLAYER</th> <th>CD</th> <th>TV AUDIO</th> </tr> </thead> <tbody> <tr> <td>Default setting</td> <td>None</td> <td>None</td> <td>None</td> <td>None</td> </tr> </tbody> </table> <p> An input source to which an component video input connector cannot be assigned is displayed as “--”.</p>	Input source	CBL/SAT	DVD	Blu-ray	GAME	AUX1	Default setting	COMP 1	COMP 2	COMP 3	None	None	Input source	AUX2	MEDIA PLAYER	CD	TV AUDIO	Default setting	None	None	None	None
CBL/SAT	DVD																																
Blu-ray	GAME																																
AUX1	AUX2																																
MEDIA PLAYER	CD																																
TV AUDIO																																	
Input source	CBL/SAT	DVD	Blu-ray	GAME	AUX1																												
Default setting	COMP 1	COMP 2	COMP 3	None	None																												
Input source	AUX2	MEDIA PLAYER	CD	TV AUDIO																													
Default setting	None	None	None	None																													

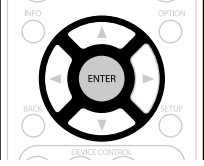
Setting items	Setting details
Set Defaults The input source name is returned to the default setting.	Yes : Reset to the defaults. No : Do not reset to the defaults.  If you select “Set Defaults” and press ENTER , the message “Reset to the default values?” is displayed. Select “Yes” or “No”, and then press ENTER . 

Source Rename

Change the display name of the selected input source. This is convenient when the input source name of your device and the input source name of this unit are different. You can change the name to suit your needs. When the renaming is completed, the name is displayed on this unit's display and on the menu screen.

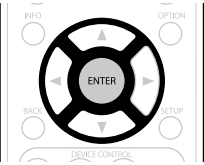
Setting details
CBL/SAT / DVD / Blu-ray / GAME / AUX1 / AUX2 / MEDIA PLAYER / CD / TV AUDIO / M-XPport / PHONO : Change the display name of the selected input source. <ul style="list-style-type: none"> Up to 12 characters can be input. For character input, see page 111. Set Defaults : The input source name is returned to the default setting. <ul style="list-style-type: none"> Yes : Reset to the defaults. No : Do not reset to the defaults.  If you select “Set Defaults” and press ENTER , the message “Reset to the default values?” is displayed. Select “Yes” or “No”, and then press ENTER . 

Hide Sources

Default settings are underlined.

Remove from the display input sources that are not used.

Setting details

CBL/SAT / DVD / Blu-ray / GAME / AUX1 / AUX2 / MEDIA PLAYER / iPod/USB / CD / HD Radio / NETWORK / TV AUDIO / M-XPport / PHONO : Select input source that is not used.

- **Show** : Use this source.
- **Hide** : Do not use this source.

NOTE

- Input sources being used in the MAIN ZONE, ZONE2 or ZONE3 cannot be selected.
- Input sources being used in the various zones cannot be deleted.
- Input sources set to "Hide" cannot be selected using the input source select button.

Source Level

Default settings are underlined.

- This function corrects the playback level of the selected input source's audio input.
- Make this setting if there are differences in the input volume levels between the different sources.

Setting details



-12dB - +12dB (0dB)

-  The analog input level and digital input level can be adjusted independently for input sources for which "DIGITAL" is assigned at "Input Assign" ([page 126](#)).

Input Select

Default settings are underlined.

Set the audio input mode and decode mode of each input source.
The input modes available for selection may vary depending on the input source.

Setting items	Setting details
Input Mode Set the audio input modes for the different input sources. It is normally recommended to set the audio input mode to "Auto".	<p>Auto : Automatically detect input signal and perform playback.</p> <p>HDMI : Play only signals from HDMI input.</p> <p>Digital : Play only signals from digital input.</p> <p>Analog : Play only signals from analog input.</p> <p>7.1CH IN : Only signals input from the 7.1CH IN connector will be played back.</p> <p></p> <ul style="list-style-type: none"> • "Digital" can be set for input sources for which "DIGITAL" is assigned at "Input Assign" (page 127). • If the input source is set to "CBL/SAT", "DVD", "Blu-ray", "MEDIA PLAYER", "CD" or "PHONO", it can be set to "Analog". • When digital signals are properly input, the DIG. indicator lights on the display. If the DIG. indicator does not light, check "Input Assign" (page 126) and the connections. • If "HDMI Control" is set to "On" and a TV compatible with the ARC is connected via the HDMI MONITOR connectors, the input mode whose input source is "TV" is fixed to ARC. • The surround mode cannot be set if the input mode is set to "7.1CH IN".
Decode Mode Set the audio decode mode for input source.	<p>Auto : Detect type of digital input signal and decode and play automatically.</p> <p>PCM : Decode and play only PCM input signals.</p> <p>DTS : Decode and play only DTS input signals.</p> <p></p> <ul style="list-style-type: none"> • This item can be set for input sources for which "DIGITAL" is assigned at "Input Assign" (page 126). • Normally set this mode to "Auto". Set "PCM" and "DTS" when inputting the corresponding input signal.

CBL/SAT	DVD
Blu-ray	GAME
AUX1	AUX2
MEDIA PLAYER	CD
TV AUDIO	

Video Source

Default settings are underlined.

Video of another input source is played back combined with the playing audio.

Setting details

Default : Play the picture and sound of the input source.

CBL/SAT / DVD / Blu-ray / GAME / AUX1 / AUX2 / MEDIA PLAYER / TV AUDIO / CD : Select video input source to view. The video of the selected input source is played along with the audio currently being played. This can be set for individual input sources.

 "Blu-ray", "GAME", "AUX2", "TV AUDIO" or "CD" can be selected only when "COMP" is assigned to the input source.

NOTE

- It is not possible to select HDMI input signals.
- Input sources for which "Hide" is selected at "Hide Sources" ([🔍 page 128](#)) cannot be selected.



Set when changing Audyssey® Setup settings.

- If you change the speaker settings after performing Audyssey® Setup, it will not be possible to set Audyssey MultEQ® XT, Audyssey Dynamic EQ® and Audyssey Dynamic Volume® (☞ [page 116](#)).
- Can be used without changing the settings. Please set if necessary.

Menu operation

1 Press **ZONE SELECT** to switch “MAIN”.

2 Press **SETUP**.
The menu is displayed on the TV screen.

3 Use Δ / ∇ to select the menu to be set or operated.

4 Press **ENTER** or \triangleright to enter the setting.

- To return to the previous item, press \triangleleft or **BACK**.
- Exiting the Menu, press **SETUP** while the menu is displayed.
The menu display disappears.



Items that can be set with the “Speakers” procedure

Audyssey® Setup (☞ [page 29, 91](#))

Manual Setup (☞ [page 131](#))

Manual Setup

Default settings are underlined.

Perform when setting the speakers manually or when changing settings made in Audyssey® Setup.



- If you change the speaker settings after performing Audyssey® Setup, it will not be possible to select Audyssey MultEQ® XT, Audyssey Dynamic EQ® and Audyssey Dynamic Volume® ([page 116](#)).
- “Manual Setup” can be used without changing the settings. Please set if necessary.



Setting items	Setting details
Amp Assign Select power amplifier usage method to match your speaker system.	Assign Mode : Set the assignment mode. <ul style="list-style-type: none"> • Main Only : Setting for 7.1-channel playback using surround back, front height, or front wide speakers. • ZONE2 : Setting to assign the unit’s built-in power amplifier for ZONE2 and output the audio in stereo. • ZONE3 : Setting to assign the unit’s built-in power amplifier for ZONE3 and output the audio in stereo. • Bi-AMP : Setting to use the front speakers via the bi-amp connection. • Front B : Setting to use the second set of front speakers for playback. You can switch the front speakers A and B to be used for playback in accordance with the 2-channel playback or multi-channel playback mode. When you select this Front B setting, also perform the “Front Speaker” (page 134) procedure. <p>NOTE</p> <p>The HDMI audio signals for the input source selected in ZONE2 are not output from the ZONE2 speakers.</p>

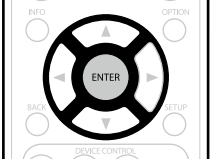

Setting items	Setting details
Speaker Config. Indicate speaker presence and select speaker size categories based on bass reproduction capability.	Front : Set the front speaker size. <ul style="list-style-type: none"> • Large : Use a large speaker that can adequately play back low frequencies. • Small : Use a small speaker that has inadequate playback capacity for low frequencies. <p>NOTE</p> <p>Do not use the outward shape of the speaker to determine selection of a “Large” or “Small” speaker. Instead, use the frequencies set in “Crossovers” (page 134) as the standard for determining bass reproduction capability.</p> <ul style="list-style-type: none"> • When “Subwoofer” is set to “No”, “Front” is automatically set to “Large”. • When “Front” is set to “Small”, “Center”, “Surround”, “Surr. Back”, “Front Height” and “Front Wide” can not be set to “Large”.
	Center : Set the presence and size of the center speaker. <ul style="list-style-type: none"> • Large : Use a large speaker that can adequately play back low frequencies. • Small : Use a small speaker that has inadequate playback capacity for low frequencies. • None : Select when a center speaker is not connected. <p>“Large” is not displayed when “Front” is set to “Small”.</p>
	Subwoofer : Set the presence of a subwoofer. <ul style="list-style-type: none"> • Yes : Use a subwoofer. • No : Select when a subwoofer is not connected. <p>When “Front” is set to “Small”, “Subwoofer” is automatically set to “Yes”.</p>
	Surround : Set the presence and size of the surround speakers. <ul style="list-style-type: none"> • Large : Use a large speaker that can adequately play back low frequencies. • Small : Use a small speaker that has inadequate playback capacity for low frequencies. • None : Select when the surround speakers are not connected. <ul style="list-style-type: none"> • When “Surround” is set to “Large”, “Surr. Back”, “Front Height” and “Front Wide” can be set to “Large”. • When “Surround” is set to “None”, “Surr. Back”, “Front Height” and “Front Wide” are automatically set to “None”.

Setting items	Setting details
Speaker Config. (Continued)	<p>Surr. Back : Set the presence, size and number of surround back speakers.</p> <ul style="list-style-type: none"> • Large : Use a large speaker that can adequately play back low frequencies. • Small : Use a small speaker that has inadequate playback capacity for low frequencies. • None : Select when the surround back speakers are not connected. <p>• 2spkr : Use two surround back speakers.</p> <p>• 1spkr : Use only one surround back speaker. When you select this setting, connect the surround back speaker to the left (L) channel.</p> <p>NOTE</p> <p>When “Assign Mode” setting (page 131) is “Main Only”, you can make the “Surr. Back” setting.</p> <hr/> <p>Front Height : Set the presence and size of the front height speakers.</p> <ul style="list-style-type: none"> • Large : Use a large speaker that can adequately play back low frequencies. • Small : Use a small speaker that has inadequate playback capacity for low frequencies. • None : Select when the front height speakers are not connected. <p>NOTE</p> <p>When “Assign Mode” setting (page 131) is “Main Only”, you can make the “Front Height” setting.</p> <hr/> <p>Front Wide : Set the presence and size of the front wide speakers.</p> <ul style="list-style-type: none"> • Large : Use a large speaker that can adequately play back low frequencies. • Small : Use a small speaker that has inadequate playback capacity for low frequencies. • None : Select when the front height speakers are not connected. <p>NOTE</p> <p>When “Assign Mode” setting (page 131) is “Main Only”, you can make the “Front Wide” setting.</p>

Setting items	Setting details
Bass Set subwoofer and LFE signal range playback.	<p>Subwoofer Mode : Select low range signals to be reproduced by subwoofer.</p> <ul style="list-style-type: none"> • LFE : The low range signal of the channel set to “Small” speaker size is added to the LFE signal output from the subwoofer. • LFE+Main : The low range signal of all channels is added to the LFE signal output from the subwoofer. <p></p> <ul style="list-style-type: none"> • “Subwoofer Mode” can be set when “Speaker Config.” – “Subwoofer” (page 131) is set to “Yes”. • Play music or a movie source and select the mode offering the strongest bass. • Select “LFE+Main” if you want the bass signals to always be produced from the subwoofer. <p>NOTE</p> <p>If “Front” and “Center” for “Speaker Config.” are set to “Large”, and “Subwoofer Mode” is set to “LFE”, no sound may be output from the subwoofers, depending on the input signal or selected sound mode.</p> <p>LPF for LFE : Set LFE signal playback range. Set this when you want to change the playback frequency of the subwoofer.</p> <p>• 80Hz / 90Hz / 100Hz / 110Hz / 120Hz / 150Hz / 200Hz / 250Hz</p>

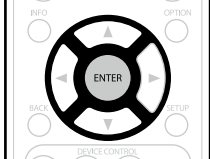
Setting items	Setting details
Distances Set distance from listening position to speakers. Measure beforehand the distance from the listening position to each speaker.	<p>Unit : Set the unit of distance.</p> <ul style="list-style-type: none"> • Feet / Meters <p>Step : Set the minimum variable width of the distance.</p> <ul style="list-style-type: none"> • 1ft / 0.1ft • 0.1m / 0.01m <p>Set Defaults : The “Distances” settings are returned to the default settings.</p> <ul style="list-style-type: none"> • Yes : Reset to the defaults. • No : Do not reset to the defaults. <p> When you select “Set Defaults” and press ENTER, the “Reset to the default values?” prompt is displayed. Select either “Yes” or “No”, and press ENTER.</p> 
	<p>Front L / Front R / F. Height L / F. Height R / Center / Subwoofer / Surround L / Surround R / Surr. Back L* / Surr. Back R* / F. Wide L / F. Wide R : Select speaker for distance setting.</p> <p>* When the “Speaker Config.” – “Surr. Back” setting (page 132) is set to “1spkr”, “Surr. Back” is displayed.</p> <ul style="list-style-type: none"> • 0.0ft – 60.0ft / 0.00m – 18.00m : Set the distance. <p> The speakers that can be selected differ depending on the “Amp Assign” (page 131) and “Speaker Config.” (page 131) settings.</p> <p>• Default settings :</p> <p>Front L / Front R / F. Height L / F. Height R / Center / Subwoofer / Front Wide L / Front Wide R : 12.0 ft (3.60 m)</p> <p>Surround L / Surround R / Surr. Back L / Surr. Back R : 10.0 ft (3.00 m)</p> <ul style="list-style-type: none"> • Set the difference in the distance between the speakers to less than 20.0 ft (6.00 m). <p>NOTE</p> <p>Speakers set to “None” in “Speaker Config.” (page 131) are not displayed.</p>

Setting items	Setting details
Levels Set the volume of the test tone to be the same when it is output from each speaker.	<p>Test Tone Start : Output test tone.</p> <ul style="list-style-type: none"> • Front L / F. Height L / Center / F. Height R / Front R / F. Wide R / Surround R / Surr. Back R* / Surr. Back L* / Surround L / F. Wide L / Subwoofer : Select speaker to output test tone. * When the “Speaker Config.” – “Surr. Back” setting (page 132) is set to “1spkr”, “Surr. Back” is displayed. <ul style="list-style-type: none"> • -12.0dB – +12.0dB (0.0dB) : Adjust the volume. <p> When “Levels” is adjusted, the adjusted values are set for all the sound modes.</p> <p>NOTE</p> <ul style="list-style-type: none"> • Speakers set to “None” in the “Speaker Config.” (page 131) settings are not displayed. • When a headphones jack is inserted in the PHONES jack of this unit, the “Levels” is not displayed. <p>Set Defaults : The “Levels” settings are returned to the default settings.</p> <ul style="list-style-type: none"> • Yes : Reset to the defaults. • No : Do not reset to the defaults. <p> When you select “Set Defaults” and press ENTER, the “Reset to the default values?” prompt is displayed. Select either “Yes” or “No”, and press ENTER.</p> 

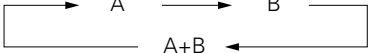
Setting items	Setting details
<p>Crossovers Set the maximum frequency of the bass signal output from each channel to the subwoofer. Set the Crossover Frequency to suit the bass reproduction capability of the speaker being used.</p>	<p>Crossover : Set the crossover frequency. <ul style="list-style-type: none"> • 40Hz / 60Hz / 80Hz / 90Hz / 100Hz / 110Hz / 120Hz / 150Hz / 200Hz / 250Hz / Individual : Set the crossover frequency for all speakers. See the speaker manual for information concerning speaker crossover frequency. <p>The following settings can be set when the “Crossover” setting is set to “Individual”.</p> <ul style="list-style-type: none"> • Front / Center / Surround / Surr. Back / Front Height : Select speaker for setting of crossover frequency. • 40Hz / 60Hz / 80Hz / 90Hz / 100Hz / 110Hz / 120Hz / 150Hz / 200Hz / 250Hz : Set the crossover frequency. <p> “Crossovers” can be set when the “Bass” – “Subwoofer Mode” (page 132) setting is “LFE+Main”, or when you have a speaker that is set to “Small”.</p> <ul style="list-style-type: none"> • Always set the crossover frequency to “80Hz”. When using small speakers, however, we recommend setting the crossover frequency to a higher frequency. • For speakers set to “Small”, sound below the crossover frequency is cut from the sound output. The cut bass sound is output from the subwoofer or front speakers. • The speakers that can be set when “Individual” is selected differ depending on to the “Subwoofer Mode” setting (page 132). <ul style="list-style-type: none"> • When “LFE” is selected, speakers set to “Small” at “Speaker Config.” can be set. If the speakers are set to “Large”, “Full Band” is displayed and the setting cannot be made. • If set to “LFE+Main”, this setting can be made regardless of the speaker size. </p>
<p>Front Speaker Set the front speakers to use.</p> <p>NOTE This can be set when “Assign Mode” is set to “Front B” (page 131).</p>	<p>A : Front speaker A is used. B : Front speaker B is used. A+B : Both front speakers A and B are used.</p> <p> This can also be set by pressing SPKR A/B on the main unit. Each time SPKR A/B is pressed, the setting is changed as shown below.</p>  <pre> graph LR A --> B B --> A+B A+B --> A </pre>



To use this unit by connecting it to a home network (LAN), you must configure network settings. If you set up your home network (LAN) via DHCP, set "DHCP" to "On" (use the default setting). This allows this unit to use your home network (LAN).

If you assign an IP address for each device, you must use the "IP Address" setting to assign an IP address to this unit and enter the information about your home network (LAN) such as the gateway address and subnet mask.

Menu operation

- 1** Press **ZONE SELECT** to switch "MAIN".
- 2** Press **SETUP**.
The menu is displayed on the TV screen.
- 3** Use Δ / ∇ to select the menu to be set or operated.
- 4** Press **ENTER** or \blacktriangleright to enter the setting.
 - To return to the previous item, press \blacktriangleleft or **BACK**.
 - Exiting the Menu, press **SETUP** while the menu is displayed.
The menu display disappears.



Items that can be set with the "Network" procedure

Information (👉 page 136)

IP Control (👉 page 136)

Friendly Name (👉 page 136)

Settings (👉 page 137)

Maintenance Mode (👉 page 138)

Information

Display network information.

Setting details

Friendly Name / DHCP=On or Off / IP Address / MAC Address

 MAC Address is required to make a vTuner account.

IP Control

Default settings are underlined.

Set the network function on/off during standby.

Setting details

Off In Standby : Suspend network function during standby.

Always On : Network is on during standby. Main unit operable with a network compatible controller.

 Set to "Always On" when using the web control function.

NOTE

When "IP Control" is set to "Always On", it consumes more standby power.

Friendly Name

The Friendly Name is the name of this unit displayed on the network. You can change the Friendly Name according to your preferences.

Setting items

Edit Name

Edits Friendly Name.

Set Defaults

Restores Friendly Name, which you had changed, to the default setting.

Setting details

- The default Friendly Name on first use is "marantz SR7007".
- Up to 63 characters can be input.
- For character input, see [page 111](#).

Yes : Reset to the defaults.

No : Do not reset to the defaults.

 When you select "Set Defaults" and press **ENTER**, the "Reset to the default values?" prompt is displayed. Select either "Yes" or "No", and press **ENTER**.

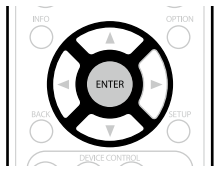

Settings

Default settings are underlined.

Make settings for wired LAN.

Only set "Settings" when connecting to a network without a DHCP function.

Setting details

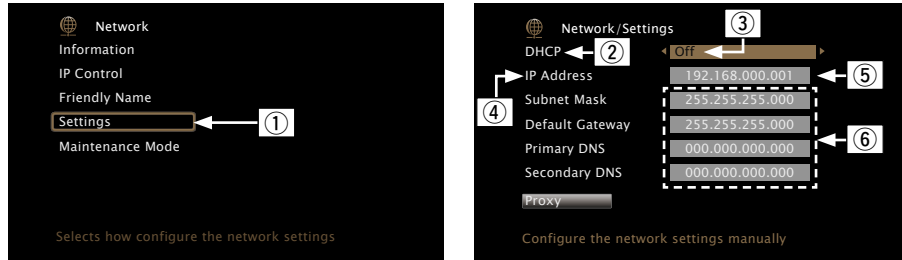

① On the menu, select "Network" – "Settings" and press **ENTER**.

② Use $\Delta \nabla$ to select "DHCP", then press **ENTER**.

③ Use $\triangleleft \triangleright$ to select "Off", then press **ENTER**.

④ Use $\Delta \nabla$ to select "IP Address", then press **ENTER**.

• **IP Address** : Set the IP address within the ranges shown below.

The Network Audio function cannot be used if other IP addresses are set.

CLASS A: 10.0.0.1 – 10.255.255.254

CLASS B: 172.16.0.1 – 172.31.255.254

CLASS C: 192.168.0.1 – 192.168.255.254

⑤ Use $\Delta \nabla \triangleleft \triangleright$ to input the address and press **ENTER**.

⑥ Use $\Delta \nabla$ to select the setting item, then press **ENTER**.

• **Subnet Mask** : When connecting an xDSL modem or terminal adapter directly to this unit, input the subnet mask indicated in the documentation supplied by your provider. Normally input 255.255.255.0.

• **Default Gateway** : When connected to a gateway (router), input its IP address.

• **Primary DNS, Secondary DNS** : If there is only one DNS address indicated in the documentation supplied by your provider, input it at "Primary DNS". If two or more DNS are provided by your provider, enter both Primary DNS and Secondary DNS.

The display returns to the original screen.

• When connecting to the network via a Proxy server, select "Proxy" and press **ENTER** ([page 138](#) "Proxy settings").

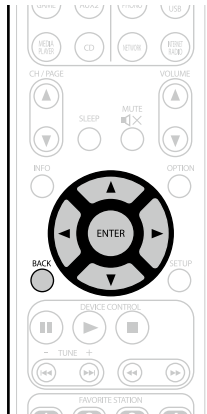

Setting details



- If you are using a broadband router (DHCP function), there is no need to make the settings at "IP Address" and "Proxy", since the DHCP function is set to "On" in this unit's default settings.
- If this unit is being used connected to a network without the DHCP function, the network settings must be made. In this case, some knowledge of networks is required. For details, consult a network administrator.
- If you cannot connect to the Internet, recheck the connections and settings ([page 27](#)).
- If you do not understand about Internet connection, contact your ISP (Internet Service Provider) or the store from which you purchased your computer.
- When you want to cancel the setting during IP address input, press \triangleleft or **BACK**.

Setting details

Proxy settings

Make this setting when connecting to the Internet via a proxy server.

Make the proxy settings only when you connect to the Internet via a proxy server that is on your internal network or provided by your provider, etc.

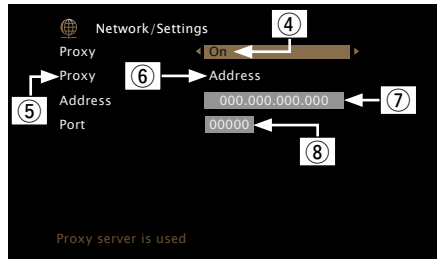
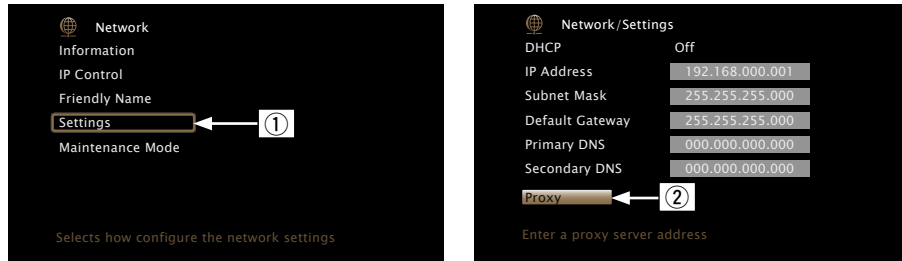

① On the menu, select "Network" – "Settings" and press **ENTER**.

② Use $\Delta \nabla$ to select "Proxy" and press **ENTER**.

③ Press **ENTER** again.

④ Use $\triangleleft \triangleright$ to select "On" and press **ENTER**.

⑤ Press ∇ to select "Proxy", then press **ENTER**.

⑥ Use $\triangleleft \triangleright$ to select "Address" or "Name", and then press **ENTER**.

Address : Select when inputting by address.

Name : Select when inputting by domain name.

⑦ Press ∇ to select "Address" or "Name", then press **ENTER**.

When "Address" is selected in step ⑥ : Use $\Delta \nabla \triangleleft \triangleright$ to enter the proxy server address, and press **ENTER**.

When "Name" is selected in step ⑥ : Use the software keyboard ([page 111](#)) to enter the domain name, and select **OK**.

• For character input, see [page 111](#).

⑧ Press ∇ to select "Port", then press **ENTER**. Use $\Delta \nabla \triangleleft \triangleright$ to input the proxy server port number and press **ENTER**.

Setup is complete.

⑨ Press \triangleleft or **BACK**.

The display returns to the original screen.

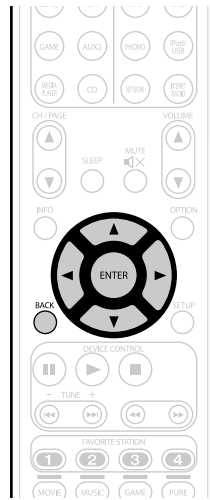

Maintenance Mode

Use when receiving maintenance from a marantz service engineer or custom installer.

Setting details

NOTE

Only use this function if so instructed by a marantz serviceperson or installer.



Make various other settings.

Menu operation

- 1** Press **ZONE SELECT** to switch “MAIN”.
- 2** Press **SETUP**.
The menu is displayed on the TV screen.
- 3** Use Δ / ∇ to select the menu to be set or operated.
- 4** Press **ENTER** or \blacktriangleright to enter the setting.
 - To return to the previous item, press \blacktriangleleft or **BACK**.
 - Exiting the Menu, press **SETUP** while the menu is displayed.
The menu display disappears.

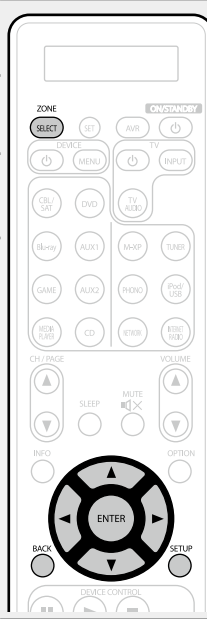

Items that can be set with the “General” procedure

Language ([page 140](#))

ZONE2 Setup / ZONE3 Setup ([page 140](#))

Zone Rename ([page 141](#))

Trigger Out 1 / Trigger Out 2 ([page 141](#))

Auto Standby ([page 141](#))

Front Display ([page 141](#))

Information ([page 142](#))

Firmware ([page 143](#))

Setup Lock ([page 144](#))

Language

Default settings are underlined.

Set the language for display on the menu screen.

Setting details

English / Français / Español



“Language” can also be set by the following procedure. However, the menu screen is not displayed. Following the display content to make the setting.

1. Press and hold the main unit's **STATUS** and **ZONE SELECT** for at least 3 seconds.
“V. Format : <NTSC>” appears on the display.
2. Press the main unit's $\Delta \nabla$ and set “Lange. : <ENGLISH>”.
3. Use the main unit's $\triangleleft \triangleright$ and set the language.
4. Press the main unit's **ENTER** to complete the setting.

ZONE2 Setup / ZONE3 Setup

Default settings are underlined.

Set the audio to play back with multi-zone (ZONE2, ZONE3).

- “ZONE2 Setup” is displayed when “ZONE2” is selected with “Assign Mode” ([page 131](#)).
- “ZONE3 Setup” is displayed when “ZONE3” is selected with “Assign Mode” ([page 131](#)).

NOTE

When HDMI ZONE2 function is used, these settings are not available.

Setting items	Setting details
Bass Adjust bass tones.	-10dB – +10dB (0dB)
Treble Adjust treble tones.	-10dB – +10dB (0dB)
High Pass Filter Make settings for cutting the low range to reduce distortion in the bass.	On : The low range is attenuated. Off : The low range is not attenuated.
Lch Level Adjust the left channel output level.	-12dB – +12dB (0dB)

Setting items	Setting details
Rch Level Adjust the right channel output level.	-12dB – +12dB (0dB)
Channel Set the signal output from multi-zone.	Stereo : Select stereo output. Mono : Select monaural output.
Volume Level Set the volume output level.	Variable : Volume adjustment is enabled by main unit and remote control unit. 40 (-40dB) : Fix volume at -40 dB. Set when adjusting volume by external amplifier. 80 (0dB) : Fix volume at 0 dB. Set when adjusting volume by external amplifier. When “Assign Mode” (page 131) is set to “ZONE2” or “ZONE3”, the “Volume Level” setting is automatically set to “Variable”.
Volume Limit Make a setting for maximum volume.	Off : Do not set a maximum volume. 60 (-20dB) / 70 (-10dB) / 80 (0dB) This is displayed from -79 dB to 18 dB when “Scale” (page 116) is set to “-79.5dB – 18.0dB”.
Power On Volume Define the volume setting that is active when the power is turned on.	Last : Use the memorized setting from the last session. Mute : Always mute when power is turned on. 1 – 98 (-79dB – 18dB) : The volume is adjusted to the set level. This is displayed from -79 dB to 18 dB when “Scale” (page 116) is set to “-79.5dB – 18.0dB”.
Mute Level Set the amount of attenuation when muting is on.	Full : The sound is muted entirely. -40dB : The sound is attenuated by 40 dB down. -20dB : The sound is attenuated by 20 dB down.

Zone Rename

Change the display title of each zone to one you prefer.

Setting details

MAIN ZONE / ZONE2 / ZONE3

- Up to 10 characters can be input.
- For character input, see [page 111](#).

Trigger Out 1 / Trigger Out 2

Selects when to activate trigger out.

For details about how to connect the DC OUT jacks, see “DC OUT jacks” ([page 95](#)).

Setting details

When setting for zone (MAIN ZONE / ZONE2 / ZONE3)

Trigger out is activated through linkage to the power of the zone set to “On”.

When setting for input source

Activate trigger out when the input source set to “On” is selected.

-  Active for the zone set to “On” with “When setting for zone”.

When setting for HDMI monitor

Activate trigger out when the HDMI monitor set to “On” is selected.

-  Activate trigger out when the HDMI monitor set to “On” is selected. Active when the “MAIN ZONE” set to “On” with “When setting for zone” is selected, and when the input source set to “On” with “When setting for input source” is selected.

- **On** : Activate trigger on this mode.
- **---** : Do not activate trigger on this mode.

Auto Standby

Default settings are underlined.

When you do not perform any operation on this unit with no audio or video input for a specified time, this unit automatically enters the standby mode. Before it enters the standby mode, “Auto Standby” is displayed on the display of this unit and the menu screen.

Setting details

30min : The unit goes into standby after 30 minutes.

60min : The unit goes into standby after 60 minutes.

Off : The unit does not go into standby automatically.

Front Display

Default settings are underlined.

Makes settings related to the display on this unit.

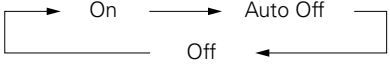
Setting items	Setting details
Display	<p>On : Display is always on.</p> <p>Auto Off : Display is off except when showing the status display.</p> <p>Off : Display is always off.</p> <p> This can also be set by pressing DISPLAY on the main unit. Each time DISPLAY is pressed, the setting is changed as shown below.</p> <div style="text-align: center;">  <pre> graph LR On --> AutoOff[Auto Off] AutoOff --> Off Off --> On </pre> </div> <p>NOTE</p> <p>When “Display” is set to “Off”, the display turns off and appears as if there is no electricity.</p>
Channel	<p>Sets whether to use the input signal display or output signal display for the channel indication on the display.</p> <p>Output : Uses the output signal display for the channel indication on the display.</p> <p>Input : Uses the input signal display for the channel indication on the display.</p>

Information

Show information about receiver settings, input signals, etc.

NOTE

This item is not compatible with the HDMI ZONE2 function.

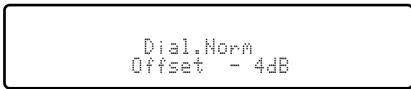
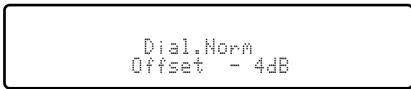
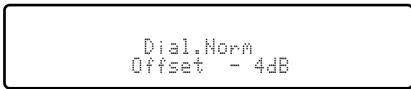
Items	Setting details				
Audio Show information about audio input signals.	<p>Sound Mode : The currently set surround mode. Input Signal : The input signal type. Format : The number of input signal channels (presence of front, surround, LFE). Sample Rate : The input signal's sampling frequency. Offset : The dialogue normalization correction value. Flag : This is displayed when inputting signals including a surround back channel. "MATRIX" is displayed with Dolby Digital EX and DTS-ES Matrix signals, "DISCRETE" with DTS-ES Discrete signals.</p> <table border="1"> <thead> <tr> <th>Dialogue normalization function</th> </tr> </thead> <tbody> <tr> <td> This function is automatically activated when playing Dolby Digital sources. It automatically corrects the standard signal level for individual program sources. The correction value can be checked using the STATUS on the main unit. </td> </tr> <tr> <td style="text-align: center;">  </td> </tr> <tr> <td> The figure is the corrected value. This cannot be changed. </td> </tr> </tbody> </table>	Dialogue normalization function	This function is automatically activated when playing Dolby Digital sources. It automatically corrects the standard signal level for individual program sources. The correction value can be checked using the STATUS on the main unit.		The figure is the corrected value. This cannot be changed.
Dialogue normalization function					
This function is automatically activated when playing Dolby Digital sources. It automatically corrects the standard signal level for individual program sources. The correction value can be checked using the STATUS on the main unit.					
					
The figure is the corrected value. This cannot be changed.					
Video Show information about HDMI input/output signals and monitor.	<p>Signal</p> <ul style="list-style-type: none"> • Resolution / Color Space / Pixel Depth <p>Monitor 1 / Monitor 2</p> <ul style="list-style-type: none"> • Interface / Resolutions 				

Items	Setting details
ZONE Show information about current settings.	<p>MAIN ZONE : This item shows information about settings for MAIN ZONE. The information displayed differs according to the input source.</p> <ul style="list-style-type: none"> • ZONE Name / Select Source / Name / Sound Mode / Input Mode / Decode Mode / HDMI / Digital / Component / Video Select / Video Mode / Content Type / Video Conversion / i/p Scaler / Resolution / Progressive Mode / Aspect Ratio etc. <p>ZONE2/3 : This item shows information about settings for ZONE2 or ZONE3.</p> <ul style="list-style-type: none"> • ZONE Name / Power / Select Source / Volume Level
Firmware	<p>Version : Displays information for the current firmware.</p>



Press **INFO** to display current source name, volume, sound mode name, and other information at the bottom of the screen.

Examples of screen display

- Status display screen

When the input source is switched.

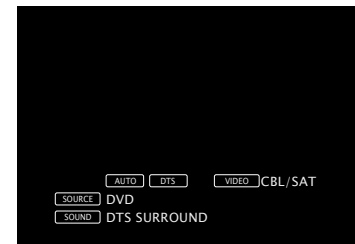

When the volume is adjusted.

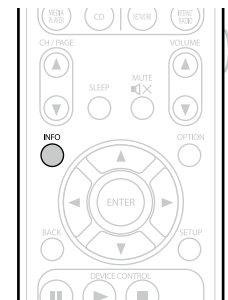
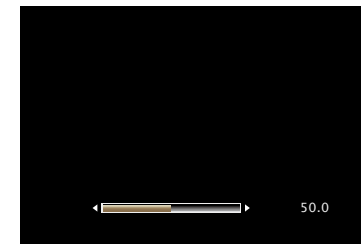

Status display: The operating status appears briefly on the screen when the input source is switched or the volume is changed.

NOTE



The status display screen cannot be displayed at a computer's resolution (e.g. VGA) or while certain 3D video contents is being played.

Firmware

Default settings are underlined.

Set whether or not to check for firmware update, update the firmware, and display update and upgrade notifications.

Setting items	Setting details												
<p>Update Update the firmware of the receiver.</p> <p>NOTE In cases where it is not possible to connect to the network after doing a firmware update, connect to the network again using "Network" (page 135).</p>	<p>Check for Update : Check for firmware updates. You can also check approximately how long it will take to complete an update. Update Start : Execute the update process. When updating starts, the STANDBY indicator becomes red and the menu screen is shut down. The amount of update time which has elapsed is displayed.</p> <ul style="list-style-type: none"> If updating fails, the set automatically retries, but if updating is still not possible, one of the messages shown below is displayed. If the display reads as shown below, check the settings and network environment, then update again. <table border="1"> <thead> <tr> <th>Display</th> <th>Description</th> </tr> </thead> <tbody> <tr> <td>Updating fail</td> <td>Updating failed.</td> </tr> <tr> <td>Login failed</td> <td>Failure to log into server.</td> </tr> <tr> <td>Server is busy</td> <td>Server is busy. Wait a while then try again.</td> </tr> <tr> <td>Connection fail</td> <td>Failure in connecting to server.</td> </tr> <tr> <td>Download fail</td> <td>Downloading of the firmware has failed.</td> </tr> </tbody> </table>	Display	Description	Updating fail	Updating failed.	Login failed	Failure to log into server.	Server is busy	Server is busy. Wait a while then try again.	Connection fail	Failure in connecting to server.	Download fail	Downloading of the firmware has failed.
Display	Description												
Updating fail	Updating failed.												
Login failed	Failure to log into server.												
Server is busy	Server is busy. Wait a while then try again.												
Connection fail	Failure in connecting to server.												
Download fail	Downloading of the firmware has failed.												

Setting items	Setting details
<p>Notifications Displays a notification message on this unit's menu screen when the latest firmware is released with "Update". Display a notification message on this unit's menu screen when downloadable firmware is released with "Add New Feature".</p>	<p>Update : The notification message is displayed for about 20 seconds when the power is turned on. Connect to broadband Internet (page 27) when using this function.</p> <ul style="list-style-type: none"> On : Display update message. Off : Do not display update message. <p> When you press ENTER during display of the notification message, the "Check for Update" screen is displayed (Refer to page 143 for more information on "Update").</p> <ul style="list-style-type: none"> Press BACK or BACK to erase the notification message. <p>Upgrade : The notification message is displayed for about 20 seconds when the power is turned on. Connect to broadband Internet (page 27) when using this function.</p> <ul style="list-style-type: none"> On : Display upgrade message. Off : Do not display upgrade message. <p> When you press ENTER during display of the notification message, the "Add New Feature" screen is displayed (Refer to page 144 for more information on "Add New Feature").</p> <ul style="list-style-type: none"> Press BACK or BACK to erase the notification message.

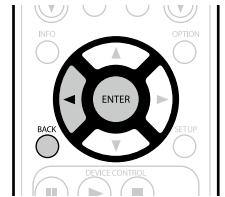

Setting items	Setting details
<p>Add New Feature Display new features that can be downloaded to this unit and perform an upgrade.</p> <p>NOTE In cases where it is not possible to connect to the network after adding a new function, connect to the network again using "Network" (page 135).</p>	<p>Upgrade Package : Display the items to be upgraded. Upgrade Status : Display a list of the additional functions provided by the upgrade. Upgrade Start : Execute the upgrade process. When the upgrade starts, the STANDBY indicator becomes red and the menu screen is shut down. During the upgrade, the amount of upgrade time which has elapsed is displayed.</p> <ul style="list-style-type: none"> • If the upgrade is not successful, an error message identical to those in "Update" will appear on the display. Check the settings and network environment and then perform the upgrade again. <p> See the marantz website for details about upgrades. When the procedure is complete, "Registered" is displayed in this menu and upgrades can be carried out. If the procedure has not been carried out, "Not Registered" is displayed. The ID number shown on this screen is needed when carrying out the procedure. The ID number can also be displayed by pressing and holding the main unit's SETUP and \triangleleft for at least 3 seconds.</p>

Notes concerning use of "Update" and "Add New Feature"

- In order to use these functions, you must have the correct system requirements and settings for a broadband Internet connection ([page 27](#)).
- Do not turn off the power until updating or upgrading is completed.
- Even with a broadband connection to the Internet, approximately 1 hour is required for the updating/upgrading procedure to be completed.
- Once updating/upgrade starts, normal operations on this unit cannot be performed until updating/upgrading is completed. Furthermore, there may be cases where backup data is reset for the parameters, etc., set on this unit.
- If the update or upgrade fails, press and hold the **ON/STANDBY** on the main unit for more than 5 seconds, or remove and re-insert the power cord. "Update retry" appears on the display and update restarts from the point at which update failed. If the error continues despite this, check the network environment.



- Information regarding the "Update" function and "Add New Feature" will be announced on the marantz web site each time related plans are defined.
- When usable new firmware is released with "Update" or "Add New Feature", a notification message is displayed on the menu screen. When you do not want to be notified, set "Notifications" – "Update" ([page 143](#)) and "Notifications" – "Upgrade" ([page 143](#)) to "Off".

Setup Lock

Default settings are underlined.

Protect settings from inadvertent change.

Setting items	Setting details
Lock	<p>On : Turn protection on. Off : Turn protection off.</p> <p> When canceling the setting, set "Lock" to "Off".</p> <p>NOTE When "Lock" is set to "On", the settings listed below can no longer be changed. Also, "Setup Locked!" is displayed if you attempt to operate related settings.</p> <ul style="list-style-type: none"> • Setup menu operations

Operating external devices with the remote control

By registering preset codes for external devices to the provided remote control, you can operate your TV and playback devices (such as Blu-ray Disc player and DVD player) with the remote control.

Registering preset codes

When preset codes are registered in the included remote control unit, it can then be used to operate any devices you have, such as DVD players or TVs made by different manufacturers.

Buttons used for operating the devices

- ① **DEVICE** For switching power of each device on or off.
- ② **△▽◀▶, ENTER, BACK** For menu operation of each device.
- ③ **MENU, INFO, OPTION, SETUP** For displaying the menu of each device.
- ④ **II, ▶, ■, I◀◀, ▶▶I, ◀◀, ▶▶**
- ⑤ Number button (0 – 9, +10)
- ⑥ **CH/PAGE ▲▼**
- ⑦ **TV** , **TV INPUT** For operating a TV
This button is enabled in any mode.

For details on operation with the remote control unit, see pages [41](#), [44](#), [53](#), [56](#), [60](#), [63](#), [66](#), [68](#), [149](#), [150](#)

NOTE

The preset code cannot be registered to **M-XP**, **TUNER**, **PHONO**, **iPod/USB**, **NETWORK** and **INTERNET RADIO**.

Registering preset codes

The following two methods can be used for registering the reset code.

- ① Entering a 4-digit code
- ② Scanning the code table

Entering a 4-digit code

See the preset code list table for the code to be input.

- 1 Press and hold the input source select buttons for the appliance to control, and press SET until the indicator blinks twice.**
The back light flashes.

NOTE

Note that the group numbers that can be registered are predefined for each input source select button ([page 147](#)).

- 2 Press the 4-digit code for the appliance using 0 – 9 (code table at the end of this manual).**
When the settings are complete, "OK" is shown in the remote control display.

NOTE

If "NG" is displayed in the remote control display, repeat steps 1 and 2, and enter the same code again.

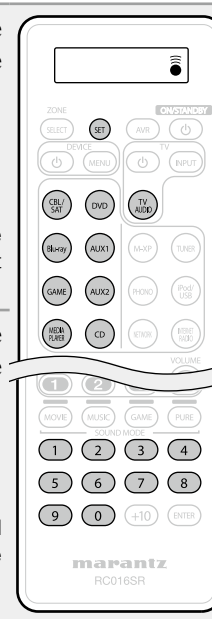

Scanning the code table

- 1 Switch the power on of the device for which you want to set the preset code.**
- 2 Press and hold the input source select buttons for the appliance to control, and press SET until the indicator blinks twice.**
The back light flashes.
- 3 Aim the remote control at the appliance and slowly alternate between pressing CH/PAGE ▲ and DEVICE for the appliance.**
The preset code is shown in the remote control display.
- 4 Stop when the appliance turns off.**
- 5 Press ENTER once to lock in the code.**



- Some manufacturers use more than one type of remote control code. Preset codes to change the number and verify correct operation.
- If the AV device is not a marantz device, or if the device does not operate even when the preset code is registered, use the learning function. Remote codes for different devices can be remembered for use by the marantz remote control included with this device.

NOTE

Depending on the model and year of manufacture of your device, some buttons may not operate.

Check the registered preset code

1 Press and hold the input source select buttons for the appliance to control, and press SET until the indicator blinks twice.
The back light flashes.

2 Press INFO.
The indicator blinks twice, after which the set code is shown for 3 seconds in the remote control display.

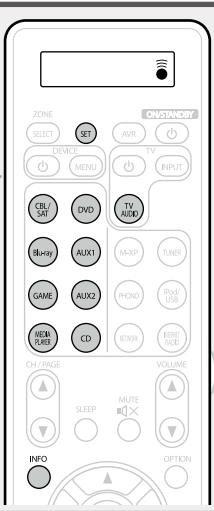

Remote control operation modes

By default, the input source select buttons on the remote control perform only the input source select operation. To operate an external device with this remote control, set the preset code in "List of preset codes" (page 183) for the device you want to register to each input source select button.

For how to set preset codes to buttons, see "Registering preset codes" (page 145).

If you register preset codes on this remote control, the input source select buttons on the remote control can perform the following two functions.

- ① The function to switch input sources on this unit (AVR operation mode)
- ② The function to make this remote control switch to the mode in which you can operate the device registered to the button (External device operation mode)

How to switch operation modes

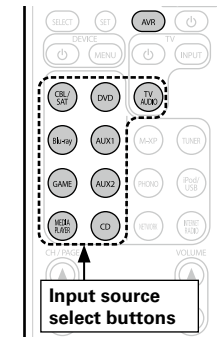
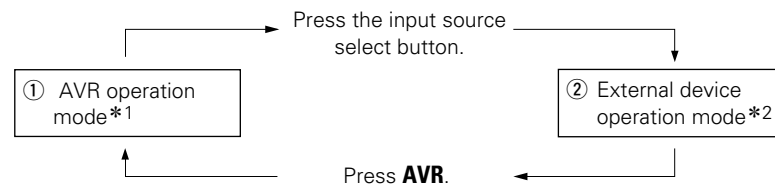









*1 The mode in which you can operate this unit.

*2 If you press one of these buttons, the input source on this unit changes and the remote control switches to the mode in which you can operate the external device registered to that button.

□ Devices that can be registered to input source select buttons on the remote control

The types of devices that can be registered to each input source select button on this remote control are assigned as shown in the following table. Register the preset code under the desired device name in "List of preset codes" (page 183).

Preset codes that can be registered to CBL/SAT, Blu-ray, GAME, MEDIA PLAYER, DVD, AUX1, AUX2, and CD buttons

Button	Default preset mode	Available change to preset
	AVR	CBL/SAT group
		BD group DVD group
		CBL/SAT group BD group DVD group CD group
		CBL/SAT group
		BD group DVD group
		CBL/SAT group BD group DVD group CD group
		CBL/SAT group BD group DVD group CD group
		CD group



- To unregister the device from a button and reset to the default setting, set the AVR code "0000" to the button.

Preset codes that can be registered to TV buttons

Button	Default preset mode	Available change to preset
	AVR	TV group

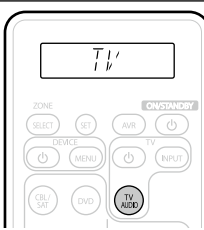

- When you press TV AUDIO that has a preset code registered to it, the "TV" indication on the remote control lights.



To perform menu operations of this unit, press **AVR** to have the remote control enter the AVR operation mode.

Operating external devices

Press the input source select button (🔍 page 36).

- The operation mode of the remote control unit is switched as shown in the table.

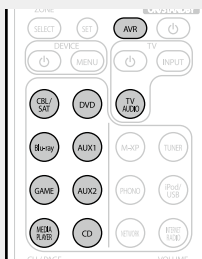

Input source select button	Input source of this unit	Operation mode
		Devices controllable with the remote control unit
	–	This unit (AVR-operation) *2
*1	CBL/SAT	Device registered on the CBL/SAT button
*1	Blu-ray	Device registered on the Blu-ray button
*1	GAME	Device registered on the GAME button
*1	MEDIA PLAYER	Device registered on the MEDIA PLAYER button
*1	DVD	Device registered on the DVD button
*1	AUX1	Device registered on the AUX1 button
*1	AUX2	Device registered on the AUX2 button
*1	CD	Device registered on the CD button
*1	TV AUDIO	Device registered on the TV AUDIO button

*1 If a preset code is registered for this button, the remote control unit of this unit can control another devices.

*2 With this mode, you can operate: HD Radio, iPod, USB memory device, turn table and network function.



When the **FAVORITE STATION** is pressed, the AVR-operation mode starts automatically.

NOTE

If the mode of the remote control unit is set to other than AVR-operation mode, press **AVR** to switch the remote control unit to the AVR-operation mode to perform the following operations:

- For menu operation by pressing **SETUP**.

Operating external devices

The supplied remote control unit can control a device other than this unit.

1 Press the input source select button to which the preset code for the device you want to operate has been registered (page 148).

2 Operate the device.

- For details, refer to the device's operating instructions.



TV group (1****) (TV) operation

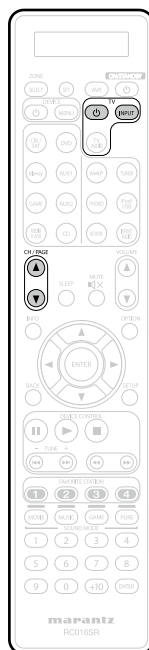

Operation buttons	Function
TV	TV power on/standby
TV INPUT	Switch TV input
CH/PAGE	Switch channels (up/down)

DVD group (2****) (DVD player / DVD recorder) operation

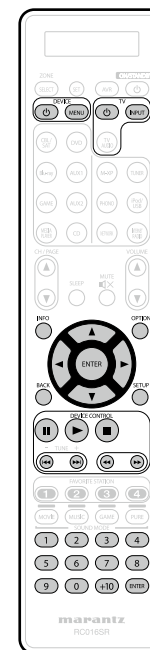

Operation buttons	Function
DEVICE	Power on/standby
DEVICE MENU	Menu
TV	TV power on/standby
TV INPUT	Switch TV input
INFO	Information
OPTION	Top menu
	Cursor operation
ENTER	Enter
BACK	Return
SETUP	Setup
	Pause
	Playback
	Stop
	Auto search (cue)
	Manual search (fast-reverse/fast-forward)
0 - 9, +10	Select title, chapter or channel selection

□ CD group (3*)**
(CD player / CD recorder) operation



Operation buttons	Function
DEVICE ⏻	Power on/off
DEVICE MENU	Menu
TV ⏻	TV power on/standby
TV INPUT	Switch TV input
ENTER	Enter
II	Pause
▶	Playback
■	Stop
I◀▶I	Auto search (cue)
◀▶	Manual search (fast-reverse/fast-forward)
0-9	Track selection

□ CBL/SAT group (4*)**
**(Set top box for satellite (SAT) / cable (CBL) /
 Media player) operation**

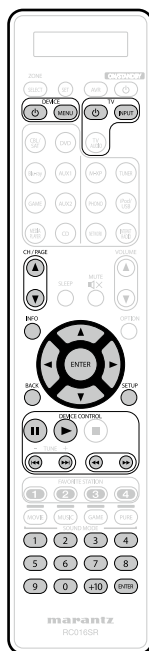

Operation buttons	Function
DEVICE ⏻	Power on/standby
DEVICE MENU	Menu
TV ⏻	TV power on/standby
TV INPUT	Switch TV input
CH/PAGE ▲▼	Switch channels (up/down)
INFO	Information
Δ▽◀▶	Cursor operation
ENTER	Enter
BACK	Return
SETUP	Setup
II	Pause
▶	Playback
I◀▶I	Auto search (cue)
◀▶	Manual search (fast-reverse/fast-forward)
0-9, +10	Channel selection

□ BD group (5*)**
(Blu-ray Disc player) operation

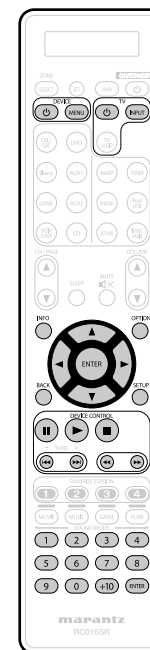

Operation buttons	Function
DEVICE ⏻	Power on/standby
DEVICE MENU	(Popup) Menu
TV ⏻	TV power on/standby
TV INPUT	Switch TV input
INFO	Information
OPTION	Top menu
Δ▽◀▶	Cursor operation
ENTER	Enter
BACK	Return
SETUP	Setup
II	Pause
▶	Playback
■	Stop
I◀▶I	Auto search (cue)
◀▶	Manual search (fast-reverse/fast-forward)
0-9, +10	Select title, chapter or channel selection

Operating learn function

- If the AV device is not a marantz device, or if the device does not operate even when the preset code is registered, use the learning function. Remote codes for different devices can be remembered for use by the marantz remote control included with this device.
- This remote control unit is capable of learning around 160 codes.

Remembering remote control codes from other devices

- 1 Place the marantz remote control and remote control from the other device approximately 5 cm apart, with the remote control signal transmission sections facing each other.**

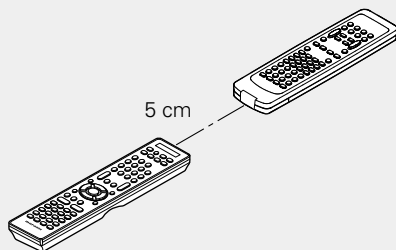

- 2 Press and hold SET until the LEARN indicator blinks.**

- 3 Press input source select buttons to select the input source.**

The input source is shown in the remote control display.

NOTE

Before using the learning function, register a preset code (see [page 145](#) "Registering preset codes") for a mode other than AVR preset (see [page 147](#)) to each input source switch button.

- 4 Select the button to be learned.**
LEARN indicator lights up.



- 5 Press and hold the button that you want to register on the other remote control until "OK" is displayed on the marantz remote control display.**

- If "NG" is shown on the remote control display, perform step 5 again. If "NG" is shown again on the remote control display, the remote control may not be able to learn the code correctly. In this case, use the specialized remote control for the device.
- If the remote control memory becomes full, "FULL" is shown on the remote control display. If you want to learn the code, you should erase other learned button.

- 6 Repeat steps 4 and 5 to learn other buttons for the same input source.**

- 7 Repeat steps 3 to 6 to learn other input sources.**

- 8 When programming of the remote control unit is completed, press SET.**

The LEARN indicator turns off, and the remote control unit exits learn mode.



- There are some remote control units that cannot be programmed, or even if they can be programmed, they may not operate correctly. If this happens, use the remote control unit supplied with the AV equipment to operate it.
- The operations of the programmed buttons override the preset memory. If you do not require the programmed buttons, erase the stored remote control codes to return to the initial settings (see [page 152](#) "Delete saved remote control codes").
- The number of buttons that can be stored varies depending on the remote control unit used. If you have stored the maximum number of buttons allowed for the remote control unit, "FULL" appears on its display.

NOTE

- The learning function is unavailable for all **ZONE SELECT, SET, AVR, ON/STANDBY**, **VOLUME**, **FAVORITE STATION, SOUND MODE** and input source select buttons in any mode.
- While in the AVR operation mode, the learning function is unavailable.
- The learning procedure does not operate correctly if the batteries have become worn.
- If no buttons are pressed for approximately 1 minutes while in the LEARN mode, the remote control unit automatically exits from the LEARN mode.

Delete saved remote control codes

Codes can be erased in three ways: by buttons, sources, and by all memory contents.

Delete remote control codes for each button

1 Press and hold **SET** until the **LEARN** indicator blinks.

2 Press input source select buttons to select the input source you want to delete.

The input source is shown in the remote control display.

3 Press and hold **ON/STANDBY** and press the learned button to be erased twice.

"ERASE" is shown in the remote control display, and the mode returns to LEARN mode.

- To return the normal mode, press **SET**.

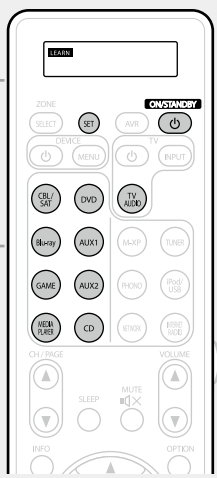

Delete remote control codes for each input source

1 Press and hold **SET** until the **LEARN** indicator blinks.

2 Press and hold **ON/STANDBY** and press the learned input source select buttons to be erased twice.

"ERASE" is shown in the remote control display.

3 Press **ENTER** to continue erasing. The indicator blinks twice and the mode returns to LEARN mode.

- To cancel the erasing operation, do not press **ENTER**, and simply press any other button.
- To return the normal mode, press **SET**.

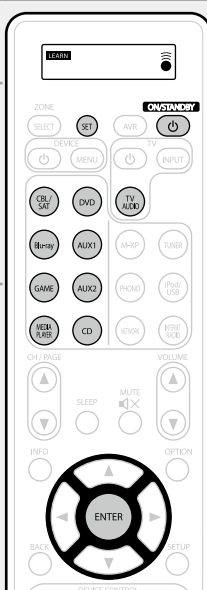

Delete remote control codes for all input sources

1 Press and hold **SET** until the **LEARN** indicator blinks.

2 Press and hold **ON/STANDBY** and press **AVR**. **LEARN** indicator lights.

3 Press **ENTER** to continue erasing. "ERASE" is shown in the remote control display, and the mode returns to LEARN mode.

- To cancel the erasing operation, do not press **ENTER**, and simply press any other button.
- To return the normal mode, press **SET**.

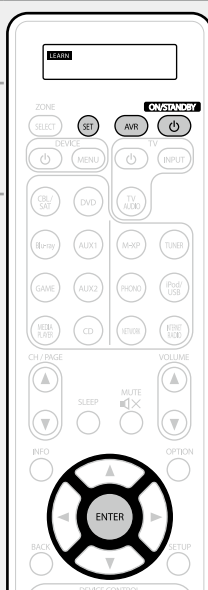

Setting the back light

Press the Light button on the side of the remote control, and the buttons on the remote control light for 2 seconds. If the Light button is pressed while the buttons are lit, the buttons remain lit for another 2 seconds.

- Backlight is set on in the factory settings.

Disabling the backlight

Press and hold both **SET** and **Light** button until  indicator flashes twice.

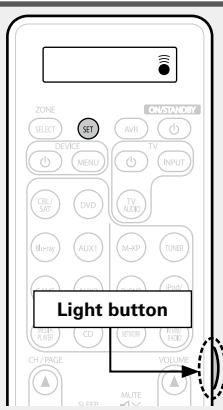

Turning the backlight on

Press and hold both **SET** and **Light** button until  indicator flashes twice.

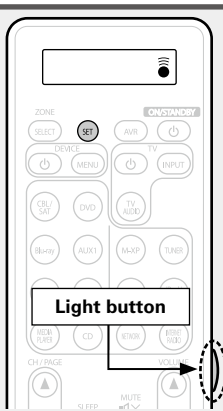

Specifying the zone used with the main remote control unit

When the **ZONE SELECT** button is pressed, only the set zone can be operated with the remote control unit.

- The factory setting is "M23".

1 Press and hold **ZONE SELECT** and **SET** for at least 3 seconds.

2 Use Δ / ∇ to set the zone to be used and press **ENTER**.



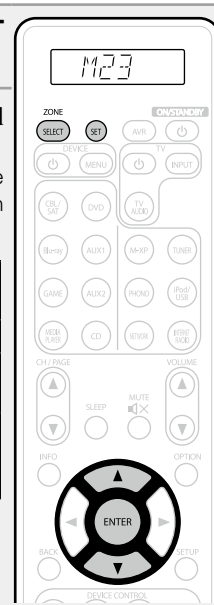

"SET" flashes four times on the remote control unit and the normal operation mode is restored.

Remote control unit display	Zone to be used
M	MAIN ZONE only
M2	MAIN ZONE / ZONE2
M23	MAIN ZONE / ZONE2 / ZONE3



Informations

Here, we list various information related to this unit.
Please refer to this information as needed.

- Part names and functions  [page 155](#)
- Other information  [page 162](#)
- Troubleshooting  [page 174](#)
- Specifications  [page 180](#)
- Index  [page 181](#)

Part names and functions

Front panel

For buttons not explained here, see the page indicated in parentheses ().

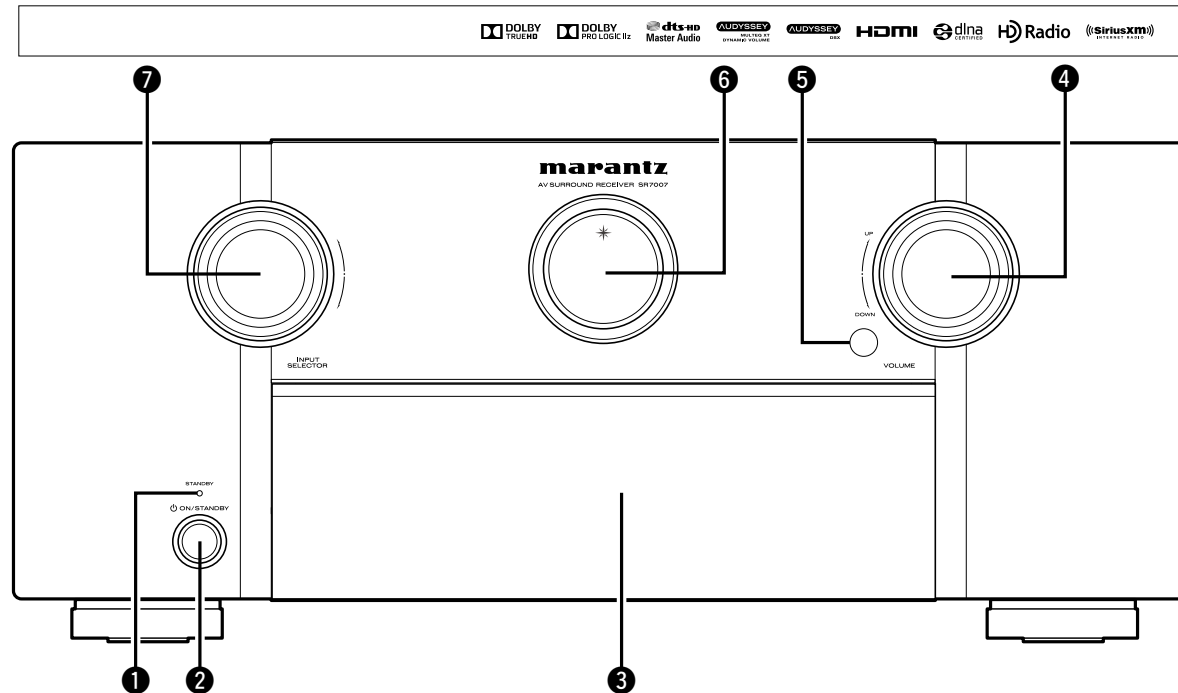

1 STANDBY indicator (36)

[STANDBY indicator status]

- Power on : Off
- Normal standby : Red
- When "HDMI Control" ([page 121](#)) is set to "On" : Orange
- When "IP Control" ([page 136](#)) is set to "Always On" : Orange

2 Power operation button (36)

(ON/STANDBY)

Turns power to this unit on and off (standby).

3 Door

When you are using buttons and/or connectors behind the door, press the bottom of the door to open it. When not using buttons and/or connectors behind the door, close it. Be careful not to catch your fingers when closing the door.

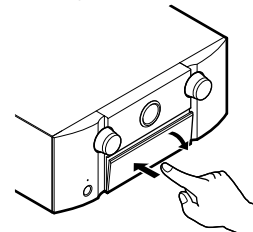

4 VOLUME knob (37, 106)

5 Remote control sensor (161)

6 Main display (157)

7 INPUT SELECTOR knob (36, 179)

With the door open

For buttons not explained here, see the page indicated in parentheses ().

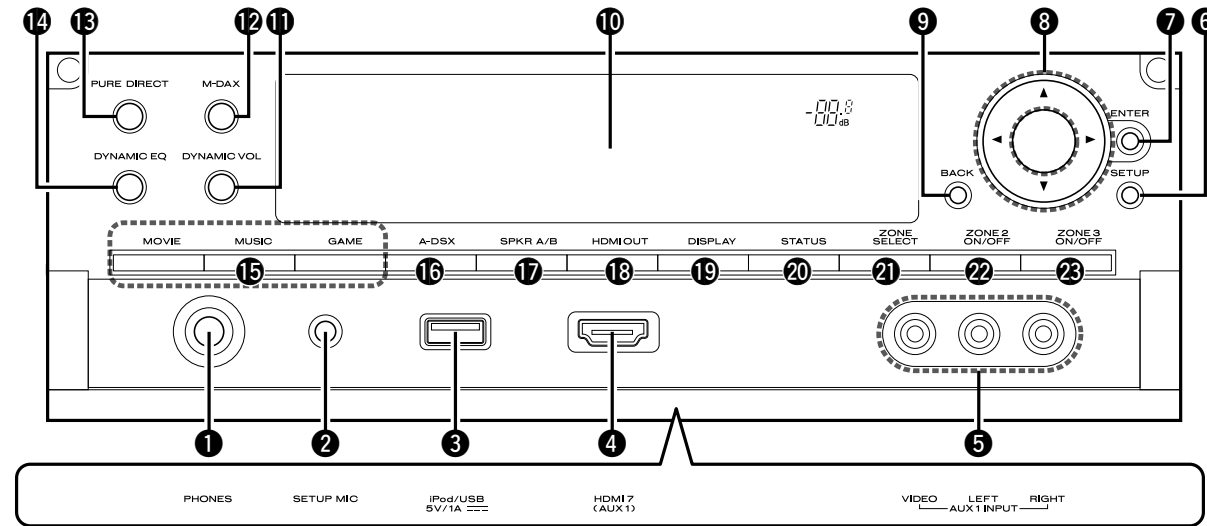

1 Headphones jack (PHONES)

When the headphones are plugged into this jack, audio will no longer be output from the connected speakers.

NOTE

To prevent hearing loss, do not raise the volume level excessively when using headphones.

- 2 SETUP MIC jack (31, 91)
- 3 iPod/USB port (20)
- 4 HDMI7 (AUX1) connector (11)
- 5 AUX1 INPUT connectors (18)

- 6 SETUP button (112, 119, 125, 130, 135, 139)
- 7 ENTER button (110, 112, 119, 125, 130, 135, 139)
- 8 Cursor buttons (▲▼◀▶) (110, 112, 119, 125, 130, 135, 139)
- 9 BACK button (112, 119, 125, 130, 135, 139)
- 10 Sub display (157)
- 11 Dynamic Volume button (DYNAMIC VOL) (117)
- 12 M-DAX button/indicator (115)
- 13 PURE DIRECT button/indicator (75)
- 14 DYNAMIC EQ button (117)
- 15 SOUND MODE buttons (75)
 - MOVIE button
 - MUSIC button
 - GAME button
- 16 Audyssey DSX® button (A-DSX) (117)
- 17 Speaker A/B switching button (SPKR A/B) (134)
- 18 HDMI OUT button (121)
- 19 DISPLAY button (141)
- 20 STATUS button (40, 55, 59, 142)
- 21 ZONE SELECT button (106)
- 22 ZONE2 ON/OFF button (106)
- 23 ZONE3 ON/OFF button (106)

Main Display

The input source name, surround mode, setting values and other information are displayed here.

Standard display

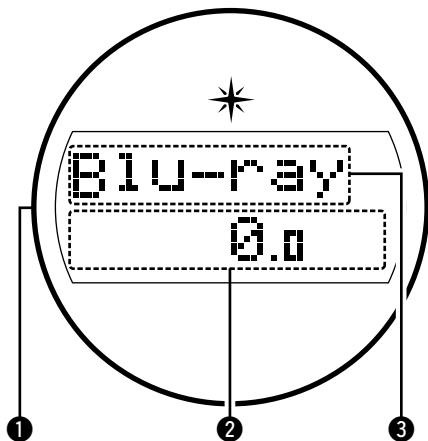

1 Light illumination

When the power to this device is switched on, the surrounding area is lit blue. The settings can be changed so the light does not switch on ([page 103](#) "Switches light illumination on/off").

2 Master volume indicator

3 Input source indicator

The currently selected input source name is displayed. If the input source name has been changed using "Source Rename" ([page 127](#)) in the menu, the input source name after the change is displayed.

Tuner display

These light according to the reception conditions when the input source is set to "FM".

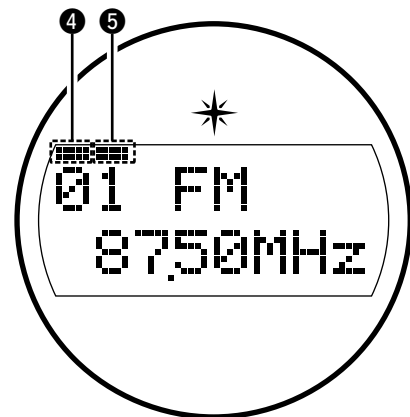

4 Lights up when the broadcast is properly turned in.

5 In the FM mode, this lights up when receiving stereo broadcasts.

Sleep timer display

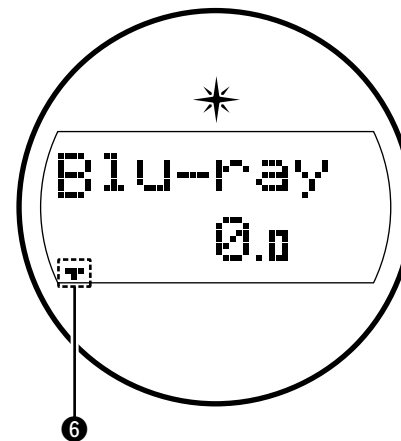

6 This lights when the sleep mode is selected ([page 98](#)).

ZONE2/ZONE3 power on display

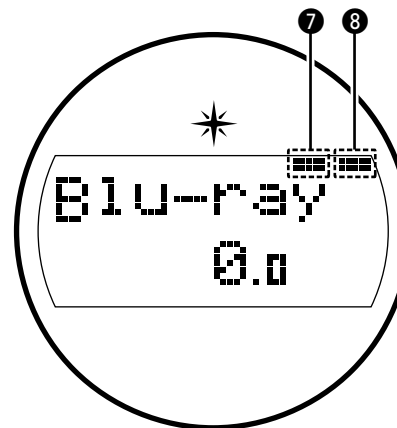

7 This lights up when ZONE2 (separate room) power is turned on ([page 104](#)).

8 This lights up when ZONE3 (separate room) power is turned on ([page 104](#)).

Sub Display

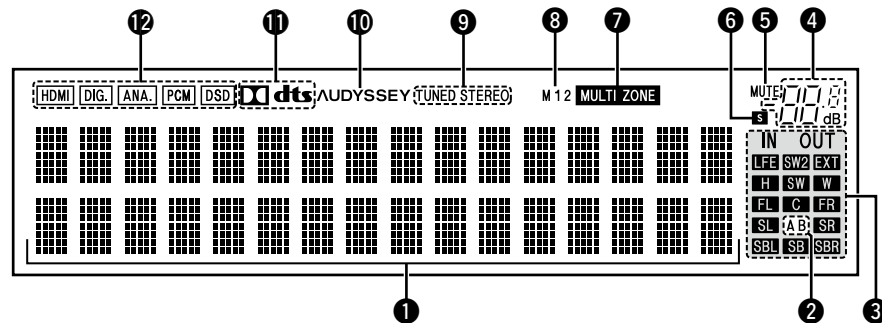

1 Information display

The input source name, sound mode, setting values and other information are displayed here.

2 Front speaker indicator

This lights according to the setting of the front A and B speakers.

3 Output signal channel indicators

Lights when audio signals are being output from the speakers.

4 Master volume indicator

5 MUTE indicator

This lights when the mute mode is selected ([page 37](#)).

6 Sleep timer indicator

This lights when the sleep mode is selected ([page 98, 106](#)).

7 MULTI ZONE indicators

This lights up when ZONE2, ZONE3 (separate room) power is turned on ([page 106](#)).

8 Monitor output indicator

These light according to the HDMI monitor output setting. When set to "Auto (Dual)", the indicators light according to connection status.

9 Tuner reception mode indicators

These light according to the reception conditions when the input source is set to "HD Radio".

STEREO : In FM mode, this lights up when receiving analog stereo broadcasts.

TUNED : Lights up when the broadcast is properly tuned in.

10 Audyssey® indicator

This indicator lights when the "MultEQ® XT" ([page 116](#)), "Dynamic EQ" ([page 117](#)), or "Dynamic Volume" ([page 117](#)) setting is set to "On".

11 Decoder indicator

These light when Dolby or DTS signals are input or when the Dolby or DTS decoder is running.

12 Input mode indicators

Set the audio input modes for the different input sources ([page 128](#)).

Rear panel

See the page indicated in parentheses ().

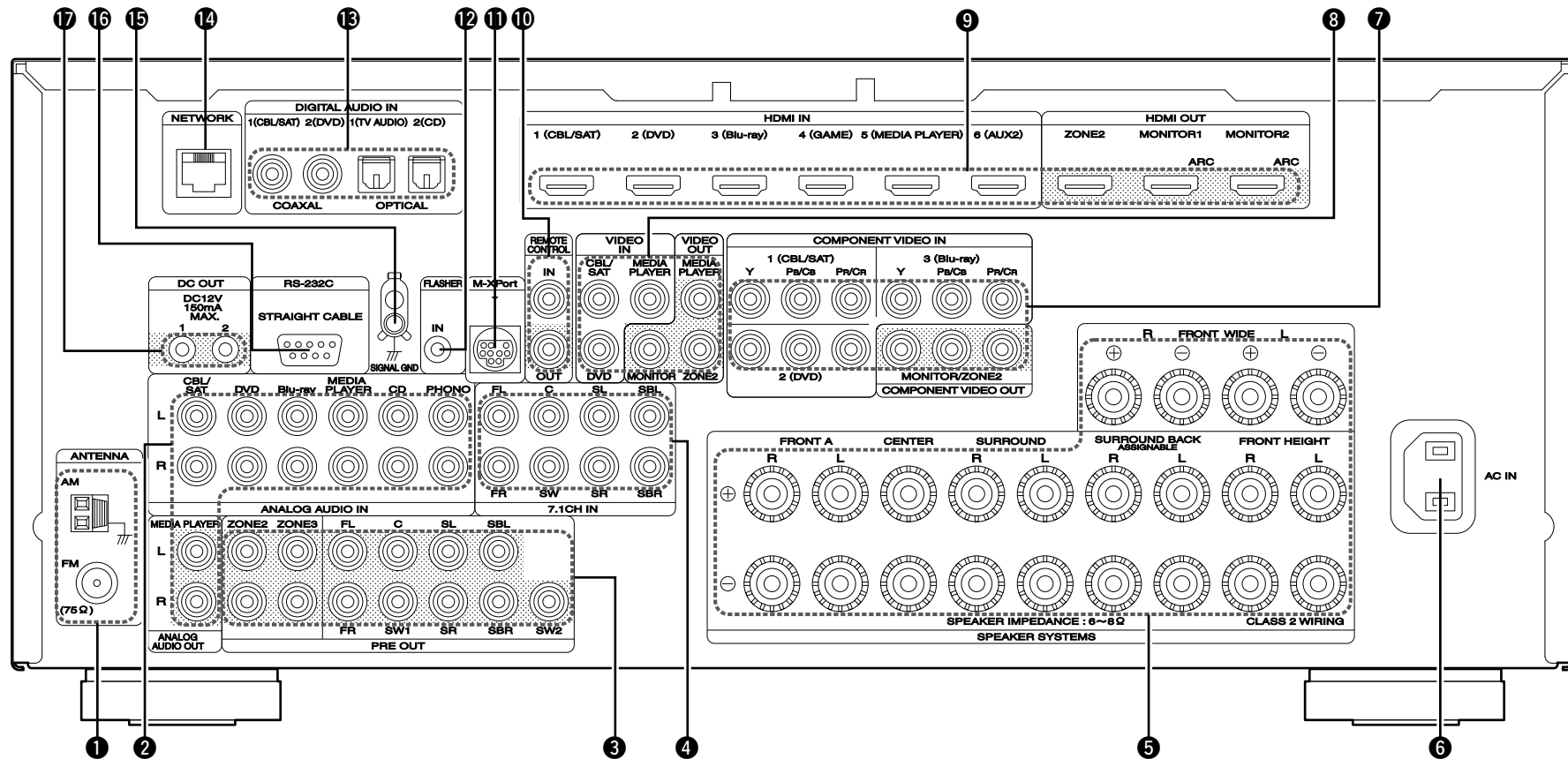

- ① FM/AM antenna terminal (ANTENNA) (23)
- ② Analog audio connectors (ANALOG AUDIO IN/ANALOG AUDIO OUT) (15, 16, 17, 19, 21, 22)
- ③ PRE OUT connectors (85, 86, 87, 88, 89, 90)
- ④ 7.1ch input connectors (7.1CH IN) (25)
- ⑤ Speaker terminals (SPEAKER SYSTEMS) (85, 86, 87, 88, 89, 90)
- ⑥ AC inlet (AC IN) (28)
- ⑦ Component video connectors (COMPONENT VIDEO IN/COMPONENT VIDEO OUT) (14, 15, 16, 17, 18, 19)
- ⑧ Video connectors (VIDEO IN/VIDEO OUT) (14, 15, 16, 19)
- ⑨ HDMI connectors (10, 11)
- ⑩ REMOTE CONTROL connectors (94)
- ⑪ M-XPort connector (24)
- ⑫ FLASHER IN jack
Used when using a control BOX or other such control devices to control this unit.
- ⑬ Digital audio connectors (DIGITAL AUDIO IN) (14, 15, 16, 17, 18, 19, 21)
- ⑭ Network connector (NETWORK) (27)
- ⑮ SIGNAL GND terminal (22)
- ⑯ RS-232C connector (95)
- ⑰ DC OUT jacks (95)

NOTE

Do not touch the inner pins of the connectors on the rear panel. Electrostatic discharge may cause permanent damage to the unit.

Remote control unit

For buttons not explained here, see the page indicated in parentheses ().

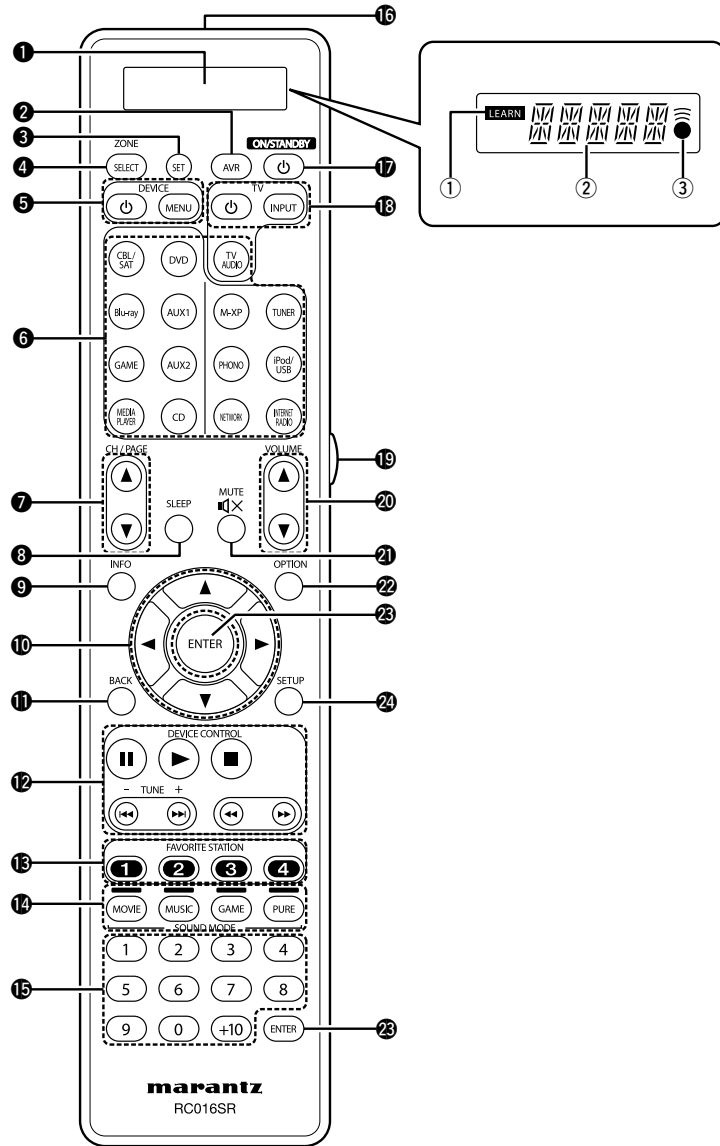

- 1 Display**
 - ① LEARN indicator
 - ② Information display
 - ③ indicator
- 2 AVR button** (146, 148)
- 3 SET button** (145, 151, 153)
- 4 ZONE SELECT button** (30, 106)
- 5 Device operation buttons (DEVICE / DEVICE MENU)** (149, 150)
- 6 Input source select buttons** (36, 106)
- 7 Channel/page search buttons (CH/PAGE ▲▼)** (41, 44, 53, 56, 60, 63, 66, 68)
- 8 SLEEP button** (98, 106)
- 9 Information button (INFO)** (142)
- 10 Cursor buttons (▲▼◀▶)** (110, 112, 119, 125, 130, 135, 139)
- 11 BACK button** (112, 119, 125, 130, 135, 139)
- 12 DEVICE CONTROL buttons** (41, 44, 60, 66)
 - Pause button ()
 - Play button ()
 - Stop button ()
 - Skip buttons (,)
 - Search buttons (,)
- Tuning up / Tuning down buttons (TUNE +, -)** (46, 47)
- 13 FAVORITE STATION buttons (1 - 4)** (71)
- 14 SOUND MODE buttons** (75)
 - MOVIE button
 - MUSIC button
 - GAME button
 - PURE button
- 15 Number buttons** (48, 50, 145, 149, 150)
- 16 Remote control signal transmitter** (161)
- 17 ON/STANDBY button ()** (36)
- 18 TV operation buttons (TV / INPUT)** (149, 150)
- 19 Light button** (153)
- 20 VOLUME buttons (▲▼)** (37, 106)
- 21 MUTE button ()** (37, 106)
- 22 OPTION button** (39, 43, 46, 55, 60, 62)
- 23 ENTER button** (110, 112, 119, 125, 130, 135, 139)
- 24 SETUP button** (112, 119, 125, 130, 135, 139)

Inserting the batteries

- ① Remove the rear lid in the direction of the arrow and remove it.
- ② Load the two batteries properly as indicated by the marks in the battery compartment.

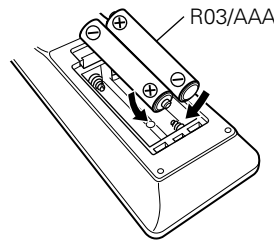
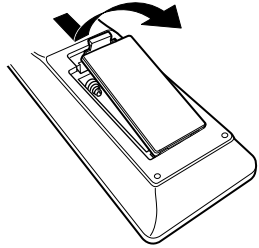

- ③ Put the rear cover back on.

NOTE

- Insert the specified batteries in the remote control unit.
- Replace the batteries with new ones if the set does not operate even when the remote control unit is operated close to the unit. (The supplied batteries are only for verifying operation. Replace them with new batteries at an early date.)
- When inserting the batteries, be sure to do so in the proper direction, following the ⊕ and ⊖ marks in the battery compartment.
- To prevent damage or leakage of battery fluid:
 - Do not use a new battery together with an old one.
 - Do not use two different types of batteries.
 - Do not attempt to charge dry batteries.
 - Do not short-circuit, disassemble, heat or dispose of batteries in flames.
 - Do not keep the battery in a place exposed to direct sunlight or in places with extremely high temperatures, such as near a heater.
- If the battery fluid should leak, carefully wipe the fluid off the inside of the battery compartment and insert new batteries.
- Remove the batteries from the remote control unit if it will not be in use for long periods.
- Used batteries should be disposed of in accordance with the local regulations regarding battery disposal.
- The remote control unit may function improperly if rechargeable batteries are used.

Operating range of the remote control unit

Point the remote control unit at the remote sensor when operating it.

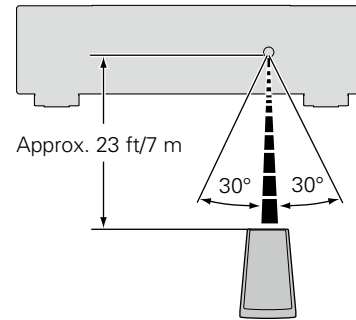

NOTE





- The set may function improperly or the remote control unit may not operate if the remote control sensor is exposed to direct sunlight, strong artificial light from an inverter type fluorescent lamp or infrared light.
- When using 3D video devices that transmit radio communication signals (such as infrared signals etc) between the various units (such as the monitor, 3D glasses, 3D transmitter unit etc), the remote control unit may not operate due to interference from those radio communication signals. If this occurs, adjust the direction and distance of the 3D communication for each unit, and check that the remote control unit operation is not affected by these signals.

Other information

- ❑ **Trademark information** (👉 [page 162](#))
- ❑ **Surround** (👉 [page 163](#))
- ❑ **Relationship between video signals and monitor output** (👉 [page 169](#))
- ❑ **Explanation of terms** (👉 [page 171](#))

Trademark information

This product uses the following technologies (Random order):

 
<p>Manufactured under license from Audyssey Laboratories™, U.S. and foreign patents pending. Audyssey MultEQ® XT, Audyssey Dynamic EQ®, Audyssey Dynamic Volume® and Audyssey DSX® are registered trademarks of Audyssey Laboratories.</p>
 
<p>Manufactured under license from Dolby Laboratories. "Dolby", "Pro Logic" and the double-D symbol are trademarks of Dolby Laboratories.</p>

<p>Manufactured under license under U.S. Patent Nos: 5,956,674; 5,974,380; 6,226,616; 6,487,535; 7,212,872; 7,333,929; 7,392,195; 7,272,567 & other U.S. and worldwide patents issued & pending. DTS-HD, the Symbol, & DTS-HD and the Symbol together are registered trademarks & DTS-HD Master Audio is a trademark of DTS, Inc. Product includes software. © DTS, Inc. All Rights Reserved.</p>
<h1>HDMI</h1>
<p>The terms HDMI and HDMI High-Definition Multimedia Interface, and the HDMI Logo are trademarks or registered trademarks of HDMI Licensing LLC in the United States and other countries.</p>
 
<p>"Made for iPod" and "Made for iPhone" mean that an electronic accessory has been designed to connect specifically to iPod, or iPhone, respectively, and has been certified by the developer to meet Apple performance standards. Apple is not responsible for the operation of this device or its compliance with safety and regulatory standards. Please note that the use of this accessory with iPod, or iPhone, may affect wireless performance. AirPlay, the AirPlay logo, iPad, iPhone, iPod, iPod classic, iPod nano, iPod shuffle and iPod touch are trademarks of Apple Inc., registered in the U.S. and other countries.</p> <ul style="list-style-type: none"> • Individual users are permitted to use iPhone, iPod, iPod classic, iPod nano, iPod shuffle, and iPod touch for private copy and playback of non-copyrighted contents and contents whose copy and playback is permitted by law. Copyright infringement is prohibited by law.

<p>Windows Media and the Windows logo are trademarks or registered trademarks of Microsoft Corporation in the United States and/or other countries.</p>

This item incorporates copy protection technology that is protected by U.S. patents and other intellectual property rights of Rovi Corporation. Reverse engineering and disassembly are prohibited.

Surround

This unit is equipped with a digital signal processing circuit that lets you play program sources in the sound mode to achieve the same sense of presence as in a movie theater.

Sound modes and surround parameters

This table shows the speakers that can be used in each sound mode and the surround parameters adjustable in each sound mode.

Symbols in the table

- This indicates the audio output channels or surround parameters that can be set.
- ⊙ This indicates the audio output channels. The output channels depend on the settings of "Speaker Config." ([page 131](#)).

Sound Mode (page 75)	Channel output						
	Front L/R	Center	Surround L/R	Surround back L/R	Front height L/R	Front wide L/R	Subwoofer
DIRECT/PURE DIRECT (2channel)*1	○						⊙*2
DIRECT/PURE DIRECT (Multi-channel)*1	○	⊙	⊙	⊙*3	⊙*3	⊙*3	⊙
STEREO	○						⊙
MULTI CH IN	○	⊙	⊙	⊙	⊙*4		⊙
DOLBY PRO LOGIC IIz	○	⊙	⊙		⊙		⊙
DOLBY PRO LOGIC IIx	○	⊙	⊙	⊙			⊙
DOLBY PRO LOGIC II	○	⊙	⊙				⊙
DOLBY PRO LOGIC	○	⊙	⊙				⊙
DOLBY PRO LOGIC II A-DSX	○	⊙	⊙		⊙*5	⊙*6	⊙
DOLBY PRO LOGIC A-DSX	○	⊙	⊙		⊙*5	⊙*6	⊙
DTS NEO:6	○	⊙	⊙	⊙			⊙
DTS NEO:6 A-DSX	○	⊙	⊙		⊙*5	⊙*6	⊙
Audyssey DSX®	○	⊙	⊙		⊙*5	⊙*6	⊙
DOLBY DIGITAL	○	⊙	⊙	⊙	⊙*4		⊙
DOLBY DIGITAL Plus	○	⊙	⊙	⊙	⊙*4		⊙
DOLBY TrueHD	○	⊙	⊙	⊙	⊙*4		⊙
DTS SURROUND	○	⊙	⊙	⊙	⊙*4		⊙
DTS 96/24	○	⊙	⊙	⊙	⊙*4		⊙
DTS-HD	○	⊙	⊙	⊙	⊙*4		⊙
DTS Express	○	⊙	⊙	⊙	⊙*4		⊙
MULTI CH STEREO	○	⊙	⊙	⊙*7	⊙*8	⊙*9	⊙
VIRTUAL	○						⊙

- *1 During playback in PURE DIRECT mode, the surround parameters are the same as in DIRECT mode.
- *2 Only when "Subwoofer Mode" is set to "LFE+Main" ([page 132](#)), sound is output from the subwoofer.
- *3 A signal for each channel contained in an input signal is output as audio.
- *4 Audio is output from the front height speaker when the set sound mode name contains "+PLIIz". For information on how to check the sound mode, see [page 75](#).
- *5 Audio is output from the front height speaker when "Assign Mode" ([page 131](#)) in the menu is set to "Main Only" and "Audyssey DSX®" ([page 117](#)) is set to "On".
- *6 Audio is output from the front wide speaker when "Assign Mode" ([page 131](#)) in the menu is set to "Main Only" and "Audyssey DSX®" ([page 117](#)) is set to "On".
- *7 Audio is output from the surround back speaker when "Assign Mode" ([page 131](#)) in the menu is set to "Main Only" and "Speaker Select" ([page 114](#)) is set to "S. Back".
- *8 Audio is output from the front height speaker when "Assign Mode" ([page 131](#)) in the menu is set to "Main Only" and "Speaker Select" ([page 114](#)) is set to "F. Height".
- *9 Audio is output from the front wide speaker when "Assign Mode" ([page 131](#)) in the menu is set to "Main Only" and "Speaker Select" ([page 114](#)) is set to "F. Wide".

Sound Mode (page 75)	Surround Parameter (page 113)									
	Home Theater EQ *10 (page 113)	Loudness Management *11 (page 113)	Dynamic Compression *12 (page 113)	Low Frequency Effects *13 (page 113)	Height Gain *14 (page 114)	Speaker Select *15 (page 114)	PRO LOGIC II/IIx Music mode only			NEO:6 Music mode only
							Panorama (page 113)	Dimension (page 113)	Center Width (page 114)	Center Image (page 113)
DIRECT/PURE DIRECT (2channel)*1		<input type="radio"/>	<input type="radio"/>							
DIRECT/PURE DIRECT (Multi-channel)*1		<input type="radio"/>	<input type="radio"/>	<input type="radio"/>						
STEREO		<input type="radio"/>	<input type="radio"/>	<input type="radio"/>						
MULTI CH IN	<input type="radio"/> *16			<input type="radio"/>	<input type="radio"/>					
DOLBY PRO LOGIC IIz	<input type="radio"/>	<input type="radio"/>	<input type="radio"/>		<input type="radio"/>					
DOLBY PRO LOGIC IIx	<input type="radio"/> *17	<input type="radio"/>	<input type="radio"/>			<input type="radio"/>	<input type="radio"/>	<input type="radio"/>		
DOLBY PRO LOGIC II	<input type="radio"/> *18	<input type="radio"/>	<input type="radio"/>			<input type="radio"/>	<input type="radio"/>	<input type="radio"/>		
DOLBY PRO LOGIC	<input type="radio"/> *18	<input type="radio"/>	<input type="radio"/>							
DOLBY PRO LOGIC II A-DSX	<input type="radio"/> *18	<input type="radio"/>	<input type="radio"/>			<input type="radio"/>	<input type="radio"/>	<input type="radio"/>		
DOLBY PRO LOGIC A-DSX	<input type="radio"/> *18	<input type="radio"/>	<input type="radio"/>			<input type="radio"/>	<input type="radio"/>	<input type="radio"/>		
DTS NEO:6	<input type="radio"/> *17	<input type="radio"/>	<input type="radio"/>						<input type="radio"/>	
DTS NEO:6 A-DSX	<input type="radio"/> *17	<input type="radio"/>	<input type="radio"/>						<input type="radio"/>	
Audyssey DSX®	<input type="radio"/>	<input type="radio"/>	<input type="radio"/>	<input type="radio"/>						
DOLBY DIGITAL	<input type="radio"/> *16		<input type="radio"/>	<input type="radio"/>	<input type="radio"/>					
DOLBY DIGITAL Plus	<input type="radio"/> *16		<input type="radio"/>	<input type="radio"/>	<input type="radio"/>					
DOLBY TrueHD	<input type="radio"/> *16	<input type="radio"/>	<input type="radio"/>	<input type="radio"/>	<input type="radio"/>					
DTS SURROUND	<input type="radio"/> *16		<input type="radio"/>	<input type="radio"/>	<input type="radio"/>					
DTS 96/24	<input type="radio"/> *16			<input type="radio"/>	<input type="radio"/>					
DTS-HD	<input type="radio"/> *16			<input type="radio"/>	<input type="radio"/>					
DTS Express	<input type="radio"/> *16			<input type="radio"/>	<input type="radio"/>					
MULTI CH STEREO		<input type="radio"/>	<input type="radio"/>	<input type="radio"/>		<input type="radio"/>				
VIRTUAL		<input type="radio"/>	<input type="radio"/>	<input type="radio"/>						

- *1 During playback in PURE DIRECT mode, the surround parameters are the same as in DIRECT mode.
- *10 This item cannot be selected during DSD (SA-CD) signal playback.
- *11 This item can be selected when a Dolby TrueHD signal is played.
- *12 This item can be selected when a Dolby Digital or DTS signal is played.
- *13 This item can be selected when a Dolby Digital or DTS signal or DVD-Audio is played.
- *14 This setting is available when the set sound mode name contains "+PLIIz". For information on how to check the sound mode, see [page 75](#).
- *15 This item can be selected when "Assign Mode" [\(page 131\)](#) is set to "Main Only".
- *16 This setting is unavailable when the set sound mode name contains "+PLIIx Music". For information on how to check the sound mode, see [page 75](#).
- *17 This setting is possible when the sound mode is "PLIIx Movie" or "DTS NEO:6 Cinema".
- *18 This setting is possible when the sound mode is "PLII Movie" or "Pro Logic".

Sound Mode (page 75)	Subwoofer (page 115)	Tone *19 (page 114)	Audyssey (page 116)				M-DAX *22 (page 115)
			MultEQ® XT *20 (page 116)	Dynamic EQ *21 (page 117)	Dynamic Volume *21 (page 117)	Audyssey DSX® *20 (page 117)	
DIRECT/PURE DIRECT (2channel)*1	<input type="radio"/> *5						
DIRECT/PURE DIRECT (Multi-channel)*1	<input type="radio"/>						
STEREO		<input type="radio"/>	<input type="radio"/>	<input type="radio"/>	<input type="radio"/>		<input type="radio"/>
MULTI CH IN	<input type="radio"/>	<input type="radio"/>	<input type="radio"/>	<input type="radio"/>	<input type="radio"/>	<input type="radio"/>	
DOLBY PRO LOGIC IIz	<input type="radio"/>	<input type="radio"/>	<input type="radio"/>	<input type="radio"/>	<input type="radio"/>		<input type="radio"/>
DOLBY PRO LOGIC IIx	<input type="radio"/>	<input type="radio"/>	<input type="radio"/>	<input type="radio"/>	<input type="radio"/>	<input type="radio"/>	<input type="radio"/>
DOLBY PRO LOGIC II	<input type="radio"/>	<input type="radio"/>	<input type="radio"/>	<input type="radio"/>	<input type="radio"/>	<input type="radio"/>	<input type="radio"/>
DOLBY PRO LOGIC	<input type="radio"/>	<input type="radio"/>	<input type="radio"/>	<input type="radio"/>	<input type="radio"/>	<input type="radio"/>	<input type="radio"/>
DOLBY PRO LOGIC II A-DSX	<input type="radio"/>	<input type="radio"/>	<input type="radio"/>	<input type="radio"/>	<input type="radio"/>	<input type="radio"/>	<input type="radio"/>
DOLBY PRO LOGIC A-DSX	<input type="radio"/>	<input type="radio"/>	<input type="radio"/>	<input type="radio"/>	<input type="radio"/>	<input type="radio"/>	<input type="radio"/>
DTS NEO:6	<input type="radio"/>	<input type="radio"/>	<input type="radio"/>	<input type="radio"/>	<input type="radio"/>	<input type="radio"/>	<input type="radio"/>
DTS NEO:6 A-DSX	<input type="radio"/>	<input type="radio"/>	<input type="radio"/>	<input type="radio"/>	<input type="radio"/>	<input type="radio"/>	<input type="radio"/>
Audyssey DSX®	<input type="radio"/>	<input type="radio"/>	<input type="radio"/>	<input type="radio"/>	<input type="radio"/>	<input type="radio"/>	
DOLBY DIGITAL	<input type="radio"/>	<input type="radio"/>	<input type="radio"/>	<input type="radio"/>	<input type="radio"/>	<input type="radio"/>	
DOLBY DIGITAL Plus	<input type="radio"/>	<input type="radio"/>	<input type="radio"/>	<input type="radio"/>	<input type="radio"/>	<input type="radio"/>	
DOLBY TrueHD	<input type="radio"/>	<input type="radio"/>	<input type="radio"/>	<input type="radio"/>	<input type="radio"/>	<input type="radio"/>	
DTS SURROUND	<input type="radio"/>	<input type="radio"/>	<input type="radio"/>	<input type="radio"/>	<input type="radio"/>	<input type="radio"/>	
DTS 96/24	<input type="radio"/>	<input type="radio"/>	<input type="radio"/>	<input type="radio"/>	<input type="radio"/>	<input type="radio"/>	
DTS-HD	<input type="radio"/>	<input type="radio"/>	<input type="radio"/>	<input type="radio"/>	<input type="radio"/>	<input type="radio"/>	
DTS Express	<input type="radio"/>	<input type="radio"/>	<input type="radio"/>	<input type="radio"/>	<input type="radio"/>	<input type="radio"/>	
MULTI CH STEREO	<input type="radio"/>	<input type="radio"/>	<input type="radio"/>	<input type="radio"/>	<input type="radio"/>		<input type="radio"/>
VIRTUAL	<input type="radio"/>	<input type="radio"/>	<input type="radio"/>	<input type="radio"/>	<input type="radio"/>		<input type="radio"/>

- *1 During playback in PURE DIRECT mode, the surround parameters are the same as in DIRECT mode.
- *5 Only when "Subwoofer Mode" is set to "LFE+Main" (page 132), sound is output from the subwoofer.
- *19 This item cannot be set when "Dynamic EQ" (page 117) is set to "On".
- *20 This item cannot be set for HD audio exceeding a frequency of 96kHz or during DSD(SA-CD) signal playback.
- *21 This item cannot be set when "MultEQ® XT" (page 116) is set to "Off" or "Graphic EQ".
- *22 This item can be set when the input signal is analog, PCM 48 kHz or 44.1 kHz.
- *23 In this sound mode, bass is +6 dB, and treble is +4 dB (Default).

Types of input signals, and corresponding sound modes

This table shows the input signal that can be played in each sound mode. Check the audio signal of the input source then select the sound mode.

Symbols in the table

- This indicates the default sound mode.
- This indicates the selectable sound mode.

Sound Mode (page 75)	NOTE	Input signal types and formats																	
		ANALOG	PCM		DTS-HD		DTS					DOLBY		DOLBY DIGITAL				Super Audio CD	
			PCM (multi ch)	PCM (2ch)	DTS-HD Master Audio	DTS-HD High Resolution Audio	DTS EXPRESS	DTS ES DSCRT (With Flag)	DTS ES MTRX (With Flag)	DTS (5.1ch)	DTS 96/24	DOLBY TrueHD	DOLBY DIGITAL Plus	DOLBY DIGITAL EX (With Flag)	DOLBY DIGITAL EX (With no Flag)	DOLBY DIGITAL (5.1ch)	DOLBY DIGITAL (2ch)	DSD (multi ch)	DSD (2ch)
DTS SURROUND																			
DTS-HD MSTR	*1			●															
DTS-HD HI RES	*1				●														
DTS ES DSCRT6.1	*2*3						●												
DTS ES MTRX6.1	*2*3							●											
DTS SURROUND	*1							○	○	●									
DTS 96/24	*1										●								
DTS (-HD) + PLIIx MOVIE	*2*4			○	○	○				○	○								
DTS (-HD) + PLIIx MUSIC	*2*3			○	○	○				○	○								
DTS (-HD) + PLIIz	*2*5			○	○	○		○	○	○	○								
DTS EXPRESS	*1						●												
DTS (-HD) + NEO:6	*2*3			○	○	○				○	○								
DTS NEO:6 CINEMA	*1	○	○														○		○
DTS NEO:6 MUSIC	*1	○	○														○		○
DTS NEO:6 CINEMA A-DSX		○	○														○		
DTS NEO:6 MUSIC A-DSX		○	○														○		
Audyssey DSX®				○	○	○	○	○	○	○	○								

- *1 If "Audyssey DSX®" (page 117) is set to "On", the Audyssey DSX® effect is added to the sound mode marked with *1.
- *2 This sound mode can be selected when "Assign Mode" (page 131) is set to "Main Only".
- *3 If "Speaker Config." - "Surr. Back" (page 132) is set to "None", this sound mode cannot be selected.
- *4 If "Speaker Config." - "Surr. Back" (page 132) is set to "1spkr" or "None", this sound mode cannot be selected.
- *5 If "Speaker Config." - "Front Height" (page 132) is set to "None", this sound mode cannot be selected.

Sound Mode (☞ page 75)	NOTE	Input signal types and formats																		
		ANALOG	PCM		DTS-HD		DTS					DOLBY		DOLBY DIGITAL			Super Audio CD			
			PCM (multi ch)	PCM (2ch)	DTS-HD Master Audio	DTS-HD High Resolution Audio	DTS EXPRESS	DTS ES DSCRT (With Flag)	DTS ES MTRX (With Flag)	DTS (5.1ch)	DTS 96/24	DOLBY TrueHD	DOLBY DIGITAL Plus	DOLBY DIGITAL EX (With Flag)	DOLBY DIGITAL EX (With no Flag)	DOLBY DIGITAL (5.1ch)	DOLBY DIGITAL (2ch)	DSD (multi ch)	DSD (2ch)	
DOLBY SURROUND																				
DOLBY TrueHD	*1												●							
DOLBY DIGITAL+	*1													●						
DOLBY DIGITAL EX	*2*3														○	○	○			
DOLBY (D+) (HD) +EX	*2*3														○	○				
DOLBY DIGITAL	*1														●	●	●			
DOLBY (D) (D+) (HD) +PLIIx MOVIE	*2*4														○	○	○			
DOLBY (D) (D+) (HD) +PLIIx MUSIC	*2*3														○	○	○			
DOLBY (D) (D+) (HD) +PLIIz	*5														○	○	○			
DOLBY PRO LOGIC IIx MOVIE	*2*3	○																○		○
DOLBY PRO LOGIC IIx MUSIC	*2*3	○																○		○
DOLBY PRO LOGIC IIx GAME	*2*3	○																○		○
DOLBY PRO LOGIC IIz	*2*5	○																○		○
DOLBY PRO LOGIC II MOVIE	*1	○																○		○
DOLBY PRO LOGIC II MUSIC	*1	○																○		○
DOLBY PRO LOGIC II GAME	*1	○																○		○
DOLBY PRO LOGIC	*1	○																○		○
DOLBY PRO LOGIC II MOVIE A-DSX		○																○		
DOLBY PRO LOGIC II MUSIC A-DSX		○																○		
DOLBY PRO LOGIC II GAME A-DSX		○																○		
DOLBY PRO LOGIC A-DSX		○																○		
Audyssey DSX®													○	○	○	○	○			

- *1 If "Audyssey DSX®" (☞ page 117) is set to "On", the Audyssey DSX® effect is added to the sound mode marked with *1.
- *2 This sound mode can be selected when "Assign Mode" (☞ page 131) is set to "Main Only".
- *3 If "Speaker Config." - "Surr. Back" (☞ page 132) is set to "None", this sound mode cannot be selected.
- *4 If "Speaker Config." - "Surr. Back" (☞ page 132) is set to "1spkr" or "None", this sound mode cannot be selected.
- *5 If "Speaker Config." - "Front Height" (☞ page 132) is set to "None", this sound mode cannot be selected.

Sound Mode (🔗 page 75)	NOTE	Input signal types and formats																	
		ANALOG	PCM		DTS-HD		DTS					DOLBY		DOLBY DIGITAL				Super Audio CD	
			PCM (multi ch)	PCM (2ch)	DTS-HD Master Audio	DTS-HD High Resolution Audio	DTS EXPRESS	DTS ES DSCRT (With Flag)	DTS ES MTRX (With Flag)	DTS (5.1ch)	DTS 96/24	DOLBY TrueHD	DOLBY DIGITAL Plus	DOLBY DIGITAL EX (With Flag)	DOLBY DIGITAL EX (With no Flag)	DOLBY DIGITAL (5.1ch)	DOLBY DIGITAL (2ch)	DSD (multi ch)	DSD (2ch)
MULTI CH IN																			
MULTI CH IN	*1		●																○
MULTI CH IN + PLIIx MOVIE	*2*4		○																○
MULTI CH IN + PLIIx MUSIC	*2*3		○																○
MULTI CH IN + PLIIz	*2*5		○																○
MULTI CH IN + Dolby EX	*2*3		○																○
MULTI CH IN 7.1	*2*3		● (7.1)																
Audyssey DSX®			○																
DIRECT																			
DIRECT		○	○	○	○	○	○	○	○	○	○	○	○	○	○	○	○	○	○
PURE DIRECT																			
PURE DIRECT		○	○	○	○	○	○	○	○	○	○	○	○	○	○	○	○	○	○
Original surround mode																			
MULTI CH STEREO		○	○	○	○	○	○	○	○	○	○	○	○	○	○	○	○	○	
VIRTUAL		○	○	○	○	○	○	○	○	○	○	○	○	○	○	○	○	○	
STEREO																			
STEREO		●	○	●	○	○	○	○	○	○	○	○	○	○	○	○	○	○	○

- *1 If "Audyssey DSX®" (🔗 page 117) is set to "On", the Audyssey DSX® effect is added to the sound mode marked with *1.
- *2 This sound mode can be selected when "Assign Mode" (🔗 page 131) is set to "Main Only".
- *3 If "Speaker Config." – "Surr. Back" (🔗 page 132) is set to "None", this sound mode cannot be selected.
- *4 If "Speaker Config." – "Surr. Back" (🔗 page 132) is set to "1spkr" or "None", this sound mode cannot be selected.
- *5 If "Speaker Config." – "Front Height" (🔗 page 132) is set to "None", this sound mode cannot be selected.

Relationship between video signals and monitor output

MAIN ZONE MONITOR OUT										
Video Conversion	Input connector			Output connector			Menu displayed			
	HDMI	COMPONENT	VIDEO	HDMI	COMPONENT	VIDEO	HDMI	COMPONENT	VIDEO	
On	×	×	×	×	×	×	Only the menu is displayed		×	
On	×	×	○	○ <VIDEO>		○ <VIDEO>	○ (VIDEO)	×	×	×
On	×	○	×	○ <COMPONENT>	○ <COMPONENT>	×	○ (COMPONENT)		×	×
On	×	○	○			○ <VIDEO>		○ <VIDEO>		×
On	○	×	×	○ <HDMI>	×	×	○ (HDMI)	×	×	
On	○	×	○			○ <VIDEO>			○ <VIDEO>	×
On	○	○	×			×			×	×
On	○	○	○			○ <VIDEO>			○ <VIDEO>	×
Off	×	×	×	×	×	×	Only the menu is displayed	×	×	
Off	×	×	○			○ <VIDEO>			○ <VIDEO>	×
Off	×	○	×			×			×	×
Off	×	○	○			○ <COMPONENT>			○ <VIDEO>	×
Off	○	×	×	○ <HDMI>	×	×	Only the menu is displayed	×	×	
Off	○	×	○			○ <VIDEO>			○ <VIDEO>	×
Off	○	○	×			×			×	×
Off	○	○	○			○ <COMPONENT>			○ <VIDEO>	×

○ : Video signal input present
 × : No video signal input

○ <> : The input signal between the < > marks is output.
 × : No video signal output

○ () : Superimposed on the picture indicated in ().
 × () : Only the picture in () is output.
 × : Neither the picture nor the menu is output.

ZONE2 MONITOR OUT					
Input connector			Output connector		
HDMI	COMPONENT	VIDEO	HDMI	COMPONENT	VIDEO
×	×	×	×	×	×
×	×	○			○ <VIDEO>
×	○	×		○ <COMPONENT>	×
×	○	○			○ <VIDEO>
○	×	×	○ <HDMI>	×	×
○	×	○			○ <VIDEO>
○	○	×		○ <COMPONENT>	×
○	○	○			○ <VIDEO>

○ : Video signal input present
 × : No video signal input

○ <> : The input signal between the < > marks is output.
 × : No video signal output



The main zone video conversion function is compatible with the following formats: NTSC, PAL, SECAM, NTSC4.43, PAL-N, PAL-M and PAL-60.

NOTE

- The status display screen cannot be displayed at a computer's resolution (e.g. VGA) or while certain 3D video contents is being played.
- When the menu is operated on a computer's resolution (e.g. VGA) or during playback of certain 3D video content, the playback image switches to the menu screen image.

Video signal resolution conversion table

When “Video Conversion” (page 122) is set to “On”, “i/p Scaler” (page 122) is set to “Analog”, “Analog & HDMI” or “HDMI” are set, the resolution of the input video signal can be converted to a different resolution for output (page 6 “Converting input video signals for output (Video conversion function)”).

The relationship between the resolution of the convertible video signal and HDMI output resolution is shown in the table below.

	Input resolution	Output resolution	HDMI Output						
			480i/576i *1	480p/576p	1080i	720p	1080p	1080p 24Hz	4K *2
Video input	480i/576i		○	○	○	○	○	○	○
Component video input	480i/576i		○	○	○	○	○	○	○
	480p/576p		-	○	○	○	○	○	○
	1080i		-	-	○	○	○	○	○
	720p		-	-	○	○	○	○	○
	1080p		-	-	-	-	○	○	○
HDMI input	480i/576i		○	○	○	○	○	○	○
	480p/576p		-	○	○	○	○	○	○
	1080i		-	-	○	○	○	○	○
	720p		-	-	○	○	○	○	○
	1080p 24Hz		-	-	-	-	○*3	○*4	○
	1080p		-	-	-	-	○	○	○
	4K		-	-	-	-	-	-	○*5

○ The resolution set in “Resolution” (page 122) in the menu is output.

- Output at the same resolution as the input video signal resolution.

*1 Only output when “i/p Scaler” in the menu is set to “Off”.

*2 Output at a resolution of 3840 x 2160 (24/25/30Hz).

*3 The resolution set in “Resolution” (page 122) in the menu is set to “Auto”, and a television that does not support 1080p 24Hz video signals is connected.

*4 The resolution set in “Resolution” (page 122) in the menu is set to “Auto”, and a television that supports 1080p 24Hz video signals is connected.

*5 Output at the same resolution as the input video signal resolution.

NOTE

- Component video and video output are output at the same resolution as the input video signal resolution.
- The 4K, 3D, Computer resolution, “x.v.Color”, sYCC601 color, Adobe RGB color or Adobe YCC601 color input to HDMI is output at the same resolution as the input video signal.
- When “Video Mode” in the menu is set to “Game” or “Auto” and game contents are played, the same resolution as the input video signal is output.
- When “Resolution” in the menu is set to “Auto”, the number of pixels in the television panel connected to the HDMI output connector is automatically detected, and the optimum resolution is output according to the table above.
- If 1080p 24Hz signals input from the HDMI terminal are converted into 1080p 60Hz/1080p 50Hz for output, they are output according to the specified “Format” (page 124) setting in the menu:
 - “NTSC” – Output as 1080p 60Hz.
 - “PAL” – Output as 1080p 50Hz.
- You can not convert 60Hz into 50Hz or vice versa.
- You can not convert 50Hz into 24Hz.
- This item does not support the HDMI ZONE2 function.

Explanation of terms

A

A2DP

A2DP is one profile of Bluetooth defined for in-car devices or AV devices that use wireless communication instead of a cable.

Adobe RGB color, Adobe YCC601 color

The color space defined by Adobe Systems Inc. Because it is a wider color space than RGB, it can produce more vivid and natural images.

AirPlay

AirPlay sends (plays) contents recorded in iTunes or on an iPhone/iPod touch/iPad to a compatible device via the network.

App Store

App Store is a site that sells application software for such devices as the iPhone or iPod Touch, and is operated by Apple Inc.

Audyssey Dynamic EQ®

Dynamic EQ solves the problem of deteriorating sound quality as volume is decreased by taking into account human perception and room acoustics. Audyssey Dynamic EQ® works in tandem with Audyssey MultEQ® XT to provide well-balanced sound for every listener at any volume level.

Audyssey Dynamic Surround Expansion (A-DSX)

Audyssey DSX® is a scalable system that adds new speakers to improve surround impression. Starting with a 5.1 system Audyssey DSX® first adds Wide channels for the biggest impact on envelopment. Research in human hearing has proven that information from the Wide channels is much more critical in the presentation of a realistic soundstage than the Back Surround channels found in traditional 7.1 systems. Audyssey DSX® then creates a pair of Height channels to reproduce the next most important acoustical and perceptual cues. In addition to these new Wide and Height channels, Audyssey DSX® applies Surround Envelopment Processing to enhance the blend between the front and surround channels.

Audyssey Dynamic Volume®

Dynamic Volume solves the problem of large variations in volume level between television programs, commercials, and between the soft and loud passages of movies. Audyssey Dynamic EQ® is integrated into Dynamic Volume so that as the playback volume is adjusted automatically, the perceived bass response, tonal balance, surround impression, and dialog clarity remain the same.

Audyssey MultEQ® XT

MultEQ® XT is a room equalization solution that calibrates any audio system so that it can achieve optimum performance for every listener in a large listening area. Based on several room measurements, MultEQ® XT calculates an equalization solution that corrects for both time and frequency response problems in the listening area and also performs a fully automated surround system setup.

Auto Lip Sync

If you connect the unit to a TV that supports the Auto Lip Sync function, it can automatically correct delay between the audio and video.

B

Bluetooth

Bluetooth is a short-distance wireless communication technology used for connecting handheld devices several meters apart. This enables notebook computers, PDA s, mobile phones, etc. to connect without a cable for transmitting audio and data.

D

Deep Color

An imaging technology supported by HDMI. Unlike RGB, which uses 8 bits (256 shades) per color, it can use 10 bits (1024 shades), 12 bits (4096 shades), or 16 bits (65536 shades) to produce colors in higher definition.

Both devices linked via HDMI must support Deep Color.

DLNA

DLNA and DLNA CERTIFIED are trademarks and/or service marks of Digital Living Network Alliance. Some contents may not be compatible with other DLNA CERTIFIED® products.

Dolby Digital

Dolby Digital is a multi-channel digital signal format developed by Dolby Laboratories.

A total of 5.1 channels are played: 3 front channels ("FL", "FR" and "C"), 2 surround channels ("SL" and "SR") and the "LFE" channel for low frequencies.

Because of this, there is no crosstalk between channels and a realistic sound field with a "three-dimensional" feeling (sense of distance, movement and positioning) is achieved.

A realistic, powerful sense of presence is achieved when playing movie sources in AV rooms as well.

Dolby Digital EX

Dolby Digital EX is a 6.1-channel surround format proposed by Dolby Laboratories that allows users to enjoy in their homes the "DOLBY DIGITAL SURROUND EX" audio format jointly developed by Dolby Laboratories and Lucas Films.

The 6.1 channels of sound, including surround back channels, provide improved sound positioning and expression of space.

Dolby Digital Plus

Dolby Digital Plus is an improved Dolby Digital signal format that is compatible with up to 7.1 channels of discrete digital sound and also improves sound quality thanks to extra data bit rate performance. It is upwardly compatible with conventional Dolby Digital, so it offers greater flexibility in response to the source signal and the conditions of the playback device.

Dolby Pro Logic II

Dolby Pro Logic II is a matrix decoding technology developed by Dolby Laboratories.

Regular music such as that on CDs is encoded into 5 channels to achieve an excellent surround effect. The surround channel signals are converted into stereo and full band signals (with a frequency response of 20 Hz to 20 kHz or greater) to create a "three-dimensional" sound image offering a rich sense of presence for all stereo sources.

Dolby Pro Logic IIx

Dolby Pro Logic IIx is a further improved version of the Dolby Pro Logic II matrix decoding technology. Audio signals recorded in 2 channels are decoded to achieve a natural sound with up to 7.1 channels. There are three modes: "Music" suited for playing music, "Movie" suited for playing movies, and "Game" which is optimized for playing games.

Dolby Pro Logic IIz

Dolby Pro Logic IIz introduces a new dimension to Home Entertainment through the addition of a pair of front height channels. Compatible with stereo, 5.1-channel and 7.1-channel content, Dolby Pro Logic IIz provides enhanced spaciousness, depth and dimension to movies, concert video and video game playback while maintaining the full integrity of the source mix.

Dolby Pro Logic IIz identifies and decodes spatial cues that occur naturally in all content, directing this information to the front height channels, complementing the performance of left and right surround sound speakers. Content that is encoded with Dolby Pro Logic IIz height channel information can be even more revealing, with perceptually discrete height channel information bringing an exciting new dimension to home entertainment.

Dolby Pro Logic IIz, with front height channels is also an ideal alternative for households that cannot support the placement of back surround speakers of a typical 7.1-channel system but may have bookshelf space available to support the addition of height speakers.

Dolby TrueHD

Dolby TrueHD is a high definition audio technology developed by Dolby Laboratories, using lossless coding technology to faithfully reproduce the sound of the studio master.

This format provides the facility to support up to 8 audio channels with a sampling frequency of 96 kHz/24 bit resolution and up to 6 audio channels with a sampling frequency of 192 kHz/24 bit resolution. Dolby TrueHD is adopted for applications that put very high importance on sound quality.

Downmix

This function converts the number of channels of surround audio to less number of channels and plays back.

DTS

This is an abbreviation of Digital Theater System, which is a digital audio system developed by DTS. When playing back audio by connecting this system with a device such as DTS amplifier, accurate sound field position and realistic sound effect as if you are in a movie theater can be obtained.

DTS 96/24

DTS 96/24 is a digital audio format enabling high sound quality playback in 5.1 channels with a sampling frequency of 96 kHz and 24 bit quantization on DVD-Video.

DTS Digital Surround

DTS Digital Surround is the standard digital surround format of DTS, Inc., compatible with a sampling frequency of 44.1 or 48 kHz and up to 5.1 channels of digital discrete surround sound.

DTS-ES™ Discrete 6.1

DTS-ES™ Discrete 6.1 is a 6.1-channel discrete digital audio format adding a surround back (SB) channel to the DTS digital surround sound. Decoding of conventional 5.1-channel audio signals is also possible according to the decoder.

DTS-ES™ Matrix 6.1

DTS-ES™ Matrix 6.1 is a 6.1-channel discrete digital audio format inserting a surround back (SB) channel to the DTS digital surround sound through matrix encoding. Decoding of conventional 5.1-channel audio signals is also possible according to the decoder.

DTS Express

DTS Express is an audio format supporting low bit rates (max. 5.1 channels, 24 to 256 kbps).

DTS-HD

This audio technology provides higher sound quality and enhanced functionality than the conventional DTS and is adopted as an optional audio for Blu-ray Disc. This technology supports multi-channel, high data transfer speed, high sampling frequency, and lossless audio playback. Maximum 7.1-channels are supported in Blu-ray Disc.

DTS-HD High Resolution Audio

DTS-HD High Resolution Audio is an improved version of the conventional DTS, DTS-ES and DTS 96/24 signals formats, compatible with sampling frequencies of 96 or 48 kHz and up to 7.1 channels of discrete digital sound. High data bit rate performance provides high quality sound. This format is fully compatible with conventional products, including conventional DTS digital surround 5.1-channel data.

DTS-HD Master Audio

DTS-HD Master Audio is a lossless audio format created by Digital Theater System (DTS). This format provides the facility to support up to 8 audio channels with a sampling frequency of 96 kHz/24 bit resolution and up to 6 audio channels with a sampling frequency of 192 kHz/24 bit resolution. It is fully compatible with conventional products, including conventional DTS digital surround 5.1-channel data.

DTS NEO:6™ Surround

DTS NEO:6™ is a matrix decoding technology for achieving 6.1-channel surround playback with 2-channel sources. It includes "DTS NEO:6 Cinema" suited for playing movies and "DTS NEO:6 Music" suited for playing music.

Dynamic range

The difference between the maximum undistorted sound level and the minimum discernible level above the noise emitted by the device.

F**FLAC**

FLAC stands for Free lossless Audio Codec, and is a lossless free audio file format. Lossless means that the audio is compressed without any loss in quality. The FLAC license is as shown below.

Copyright (C) 2000,2001,2002,2003,2004,2005,2006,2007,2008,2009 Josh Coalson

Redistribution and use in source and binary forms, with or without modification, are permitted provided that the following conditions are met:

- Redistributions of source code must retain the above copyright notice, this list of conditions and the following disclaimer.
 - Redistributions in binary form must reproduce the above copyright notice, this list of conditions and the following disclaimer in the documentation and/or other materials provided with the distribution.
 - Neither the name of the Xiph.org Foundation nor the names of its contributors may be used to endorse or promote products derived from this software without specific prior written permission.
- THIS SOFTWARE IS PROVIDED BY THE COPYRIGHT HOLDERS AND CONTRIBUTORS "AS IS" AND ANY EXPRESS OR IMPLIED WARRANTIES, INCLUDING, BUT NOT LIMITED TO, THE IMPLIED WARRANTIES OF MERCHANTABILITY AND FITNESS FOR A PARTICULAR PURPOSE ARE DISCLAIMED. IN NO EVENT SHALL THE FOUNDATION OR CONTRIBUTORS BE LIABLE FOR ANY DIRECT, INDIRECT, INCIDENTAL, SPECIAL, EXEMPLARY, OR CONSEQUENTIAL DAMAGES (INCLUDING, BUT NOT LIMITED TO, PROCUREMENT OF SUBSTITUTE GOODS OR SERVICES; LOSS OF USE, DATA, OR PROFITS; OR BUSINESS INTERRUPTION) HOWEVER CAUSED AND ON ANY THEORY OF LIABILITY, WHETHER IN CONTRACT, STRICT LIABILITY, OR TORT (INCLUDING NEGLIGENCE OR OTHERWISE) ARISING IN ANY WAY OUT OF THE USE OF THIS SOFTWARE, EVEN IF ADVISED OF THE POSSIBILITY OF SUCH DAMAGE.

H**HDCP**

When transmitting digital signals between devices, this copyright protection technology encrypts the signals to prevent content from being copied without authorization.

HDMI

This is an abbreviation of High-Definition Multimedia Interface, which is an AV digital interface that can be connected to a TV or amplifier. Video signal and audio signal can be connected using 1 cable.

I**iTunes**

iTunes is the name of the multimedia player provided by Apple Inc. It enables management and playback of multimedia contents including music and movies. iTunes supports many main file formats including AAC, WAV, and MP3.

L**LFE**

This is an abbreviation of Low Frequency Effect, which is an output channel that emphasizes low frequency effect sound. Surround audio is intensified by outputting 20 Hz to 120 Hz deep bass.

M**MAIN ZONE**

The room where this unit is placed is called the MAIN ZONE.

MP3 (MPEG Audio Layer-3)

This is an internationally standardized audio data compression scheme, using the "MPEG-1" video compression standard. It compresses the data volume to about one eleventh its original size while maintaining sound quality equivalent to a music CD.

MPEG (Moving Picture Experts Group),**MPEG-2, MPEG-4**

These are the names for digital compression format standards used for the encoding of video and audio. Video standards include "MPEG-1 Video", "MPEG-2 Video", "MPEG-4 Visual", "MPEG-4 AVC". Audio standards include "MPEG-1 Audio", "MPEG-2 Audio", "MPEG-4 AAC".

P**Pairing**

Pairing is an operation required for settings to connect two Bluetooth devices. Pairing enables Bluetooth devices to access each other.

Progressive (sequential scanning)

This is a scanning system of video signal that displays 1 frame of video as one image. Compared to the interlace system, this system provides images with less flickering and bleeding.

Protection Circuit

This is a function to prevent damage to devices within the power supply when an abnormality such as an overload, excess voltage occurs or temperature for any reason.

In this unit, the STANDBY indicator blinks and the unit enters standby mode when an abnormality occurs.

S**Sampling frequency**

Sampling involves taking a reading of a sound wave (analog signal) at regular intervals and expressing the height of the wave at each reading in digitized format (producing a digital signal).

The number of readings taken in one second is called the "sampling frequency". The larger the value, the closer the reproduced sound is to the original.

Speaker impedance

This is an AC resistance value, indicated in Ω (ohms). Greater power can be obtained with this value smaller.

sYCC601 color

Like "x.v.Color", each of these color spaces defines a palette of available colors that is larger than the traditional RGB color model.

V**vTuner**

This is a free online content server for Internet radio. Note that usage fees are included in upgrade costs.

For inquiries about this service, visit the vTuner site below.

vTuner website: <http://www.radiomarantz.com>

This product is protected by certain intellectual property rights of Nothing Else Matters Software and BridgeCo. Use or distribution of such technology outside of this product is prohibited without a license from Nothing Else Matters Software and BridgeCo or an authorized subsidiary.

W**Windows Media DRM**

This is a copyright protection technology developed by Microsoft.

Content providers are using the digital rights management technology for Windows Media contained in this device (WM-DRM) to protect the integrity of their content (Secure Content) so that their intellectual property, including copyright, in such content is not misappropriated. This device uses WM-DRM software to play Secure Content (WM-DRM Software). If the security of the WM-DRM Software in this device has been compromised, owners of Secure Content (Secure Content Owners) may request that Microsoft revoke the WM-DRM Software's right to acquire new licenses to copy, display and/or play Secure Content. Revocation does not alter the WM-DRM Software's ability to play unprotected content. A list of revoked WM-DRM Software is sent to your device whenever you download a license for Secure Content from the Internet or from a PC. Microsoft may, in conjunction with such license, also download revocation list onto your device on behalf of Secure Content Owners.

Windows Media Player Ver.11 or later

This is a media player distributed free of charge by Microsoft Corporation.

It can play playlists created with Ver.11 or later of Windows Media Player, as well as WMA, DRM WMA, WAV, and other files.

WMA (Windows Media Audio)

This is audio compression technology developed by Microsoft Corporation.

WMA data can be encoded using Windows Media® Player Ver.7, 7.1, Windows Media® Player for Windows® XP and Windows Media® Player 9 Series.

To encode WMA files, only use applications authorized by Microsoft Corporation. If you use an unauthorized application, the file may not work properly.

X**x.v.Color**

This function lets HDTVs display colors more accurately. It enables display with natural, vivid colors. "x.v.Color" is trademark of Sony Corporation.

Z**ZONE2**

This unit can operate in a room other than the room where this unit is placed (MAIN ZONE) (ZONE2 playback). The room for ZONE2 playback is called ZONE2.

ZONE3

This unit can operate in a room other than the room where this unit is placed (MAIN ZONE) (ZONE3 playback). The room for ZONE3 playback is called ZONE3.

Troubleshooting

If a problem should arise, first check the following:

1. Are the connections correct?

2. Is the set being operated as described in the owner's manual?

3. Are the other devices operating properly?

If this unit does not operate properly, check the items listed in the table below. Should the problem persist, there may be a malfunction.

In this case, disconnect the power immediately and contact your store of purchase.

[General]

Symptom	Cause/Solution	Page
Power does not turn on.	<ul style="list-style-type: none"> Check whether the power plug is correctly inserted into the power outlet. The protection circuit is active. Disconnect the power plug from the electric outlet, wait 5 to 10 seconds and then insert it back into the outlet. 	36 173
Power automatically switches to standby mode.	<ul style="list-style-type: none"> The sleep timer is set. Turn on the power again, or change the sleep timer settings. "Auto Standby" is triggered when there is no operation for a set amount of time. To disable "Auto Standby", set "Auto Standby" on the menu to "Off". 	98, 106 141
Display is off.	<ul style="list-style-type: none"> Set "Display" on the menu to something other than "Off". 	141
The STANDBY indicator is blinking red in intervals of approximately 2 seconds.	<ul style="list-style-type: none"> Due to the temperature rise within this unit, the protection circuit is working. Please turn off power once, and re-apply the power after the temperature has fallen sufficiently. Please re-install this unit in a place having good ventilation. 	–
The STANDBY indicator is blinking red in intervals of approximately 0.5 seconds.	<ul style="list-style-type: none"> Please use speakers which have the specified impedance. The protection circuit has been activated because the speaker cable core wires are touching, a core wire has come loose from the terminal, or a core wire is touching the rear panel of this unit. After unplugging the power cord, take corrective action such as firmly re-twisting the core wire or taking care of the terminal, and then reconnect the wire. 	84 84

Symptom	Cause/Solution	Page
After turning on the power, the STANDBY indicator is blinking red in intervals of approximately 0.5 seconds.	<ul style="list-style-type: none"> This unit amplifier circuit has failed. Turn off the power and please contact the marantz service adviser. 	–
Set does not operate properly.	<ul style="list-style-type: none"> Reset the microprocessor. 	179

[HDMI]

Symptom	Cause/Solution	Page
No audio is output with HDMI connection.	<ul style="list-style-type: none"> Check the connection of the HDMI connectors. When outputting HDMI audio from the speakers, set "HDMI Audio Out" on the menu to "AVR". When outputting HDMI audio from a TV, set "HDMI Audio Out" on the menu to "TV". 	11 120 120
No video is output with HDMI connection.	<ul style="list-style-type: none"> Check the connection of the HDMI connectors. Set the input source to match the connected HDMI connector. Check whether the TV is compatible with copyright protection (HDCP). If connected to a device not compatible with HDCP, video will not be output correctly. 	11 11, 36 12

Symptom	Cause/Solution	Page
When the following operations are performed on devices compatible with HDMI control, the same operations occur on this unit. <ul style="list-style-type: none"> • Power ON/OFF • Switching audio output devices • Adjust volume • Switch input source 	<ul style="list-style-type: none"> • Set "HDMI Control" in the menu to "Off". Furthermore, if you do not want to link the power off operation with devices compatible with HDMI control, set "Power Off Control" in the menu to "Off". 	96 , 121
When the HDMI ZONE2 function is used and an operation is performed in MAIN ZONE, the following operations occur. <ul style="list-style-type: none"> • The player is turned off or playback pauses. • The input source on this unit automatically changes. 	<ul style="list-style-type: none"> • "HDMI Control" in the menu is set to "On". In this case, the HDMI control function set for MAIN ZONE affects playback in ZONE2. When the HDMI ZONE2 function is used, set "HDMI Control" in the menu to "Off". • When the input source for ZONE2 is "SOURCE", select an input source that is different from the one for MAIN ZONE. 	96 , 121
When the HDMI ZONE2 function is used, Dolby TrueHD/ DTS HD Master Audio/Dolby Digital/ DTS cannot be played back in MAIN ZONE.	<ul style="list-style-type: none"> • Make sure that "HDMI Audio Out" in the menu is set to "AVR". When a same input source is selected for MAIN ZONE and ZONE2, set the ZONE2 ON/OFF button to "OFF", or change the input source for ZONE2 to an input source that is different from the one for MAIN ZONE. 	120

Symptom	Cause/Solution	Page
When the HDMI ZONE2 function is used, no video or audio is output to TV in ZONE2.	<ul style="list-style-type: none"> • Make sure that the power is on for ZONE2. • Check the input source for ZONE2. • Check the output settings (resolution/audio format) for the input device 	106 106 –
When playing back the input device just to use the HDMI ZONE2 function, the TV used for MAIN ZONE is turned on.	<ul style="list-style-type: none"> • "HDMI Control" in the menu is set to "On". When using the HDMI ZONE2 function, set "HDMI Control" in the menu to "Off". 	96 , 121

[Video]

Symptom	Cause/Solution	Page
No picture appears.	<ul style="list-style-type: none"> • Check the connection between the video output terminal of this unit and the input terminal of the TV. • Match the input settings to the input terminal of the TV connected to this unit. 	10 , 14 –

[Audio]

Symptom	Cause/Solution	Page
Audio is not output.	<ul style="list-style-type: none"> • Check the connections for all devices. • Check the speaker connections and configurations. • Check whether the audio device power is turned on. • Adjust the master volume. • Cancel the mute mode. • Check the connection with the playback device and select the proper input source. • Match the input mode and the terminal assigned to be the digital input terminal. • Disconnect the headphones. No sound is output from the speakers or the PRE OUT connectors when headphones are connected. 	10,11,14,15,16,17,18,19,20,21,22,23,24,25,26,27 85, 86, 87, 88, 89, 90 – 37, 106 37, 106 36, 106 128 155
The volume does not increase.	<ul style="list-style-type: none"> • The maximum volume is set too low. Set the maximum volume using "Limit" on the menu. • Power for external devices connected to the output connectors of the unit may not be turned on. Check the power of connected external devices. 	116 –
No sound is produced from surround speaker.	<ul style="list-style-type: none"> • Check if the surround speakers are connected to the SURROUND terminals. 	–
No sound is produced from surround back speaker.	<ul style="list-style-type: none"> • Check if "Assign Mode" is set appropriately in order to output audio from the surround back speakers. • Set "Speaker Config." – "Surr. Back" on the menu to something other than "None". • Set the sound mode to something other than "STEREO" and "VIRTUAL". 	131 132 75
No sound is produced from front height speaker.	<ul style="list-style-type: none"> • Set "Speaker Config." – "Front Height" on the menu to something other than "None". 	132
No sound is produced from front wide speaker.	<ul style="list-style-type: none"> • Set "Speaker Config." – "Front Wide" on the menu to something other than "None". 	132

Symptom	Cause/Solution	Page
No sound is produced from subwoofer.	<ul style="list-style-type: none"> • Check the subwoofer connections. • Turn on the subwoofer's power. • Set "Speaker Config." – "Subwoofer" on the menu to "Yes". • If "Front" and "Center" for "Speaker Config." are set to "Large", and "Subwoofer Mode" is set to "LFE", no sound may be output from the subwoofers, depending on the input signal or selected sound mode. 	85, 86, 87, 88, 89, 90 – 131 131, 132
DTS sound is not output.	<ul style="list-style-type: none"> • Set "Decode Mode" on the menu to "Auto" or "DTS". 	128
Dolby TrueHD, DTS-HD, Dolby Digital Plus audio is not output.	<ul style="list-style-type: none"> • Make HDMI connections. 	11
Dolby PLII mode or DTS NEO:6 mode cannot be selected.	<ul style="list-style-type: none"> • Check that "Speaker Config." – "Center" or "Surround" is set to other than "None". If the speaker system is 2.0/2.1ch, this sound mode cannot be selected. • When headphones are used, Dolby PLII or DTS NEO:6 cannot be selected. 	131 –
Audyssey MultEQ [®] XT, Audyssey Dynamic EQ [®] and Audyssey Dynamic Volume [®] cannot be selected.	<ul style="list-style-type: none"> • Switch the sound mode to other than "DIRECT" or "PURE DIRECT". • When headphones are used, Audyssey MultEQ[®] XT, Audyssey Dynamic EQ[®] and Audyssey Dynamic Volume[®] cannot be selected. 	75 –
Audyssey DSX [®] cannot be selected.	<ul style="list-style-type: none"> • Check that "Speaker Config." – "Front Height" or "Front Wide" is set to other than "None". • Check that "Speaker Config." – "Center" is set to other than "None". • Switch the sound mode to DOLBY listening mode or DTS listening mode. • When headphones are used, Audyssey DSX[®] cannot be selected. 	132 131 75 –
Audyssey Dynamic EQ [®] and Audyssey Dynamic Volume [®] cannot be selected.	<ul style="list-style-type: none"> • Run Audyssey[®] Setup. 	29, 91

Symptom	Cause/Solution	Page
"M-DAX" cannot be selected.	<ul style="list-style-type: none"> Check that an analog signal or PCM signal (Sample Rate=44.1/48 kHz) is input. For playback of multichannel signals such as Dolby Digital or DTS surround, "M-DAX" cannot be used. Switch the sound mode to other than "DIRECT" or "PURE DIRECT". 	115 75
When the HDMI ZONE2 function is used, in spite of "Assign Mode" being set to "ZONE2", no audio is output from the speakers connected with this unit.	<ul style="list-style-type: none"> The HDMI audio signals selected for ZONE2 are only output to the HDMI ZONE2 OUT connector. (The HDMI audio signals selected for ZONE2 are not output from the speaker of the TV in ZONE2 that is connected to this unit.) 	–

[HD Radio]

Symptom	Cause/Solution	Page
Reception fails, or there is a lot of noise or distortion.	<ul style="list-style-type: none"> Change the antenna orientation or position. Separate the AM loop antenna from the unit. Use an FM outdoor antenna. Separate the antenna from other connection cables. 	23 23 23 23

[iPod / USB memory device / Internet radio / Media server / Flickr / Pandora / SiriusXM]





Symptom	Cause/Solution	Page
iPod cannot be played.	<ul style="list-style-type: none"> Some iPods do not support being used connected directly to the iPod/USB port. 	20
The file names are not displayed properly ("...", etc.).	<ul style="list-style-type: none"> Characters that cannot be displayed are used. This is not a malfunction. On this unit, characters that cannot be displayed are replaced with a "." (period). Invalid tags are used for files within the USB memory device connected to this unit. Use tags that are supported by this unit. 	– 42

Symptom	Cause/Solution	Page
When a USB memory device is connected, "No Connection" is displayed.	<ul style="list-style-type: none"> The set cannot recognize a USB memory device. Check the connection. This unit supports mass storage class and MTP-compatible USB memory devices. It will not recognize other USB memory devices. A USB memory device that the set cannot recognize is connected. This is not a malfunction. marantz does not guarantee that all USB memory devices will operate or receive power. USB memory device is connected via USB hub. Connect the USB memory device directly to the iPod/USB port. The unit supports file structures with up to 8 levels and a total maximum of 5000 subfolders and files per 1 folder. Change the file structure of the USB memory device if necessary. 	20 – – – 42
Files on a USB memory device cannot be played.	<ul style="list-style-type: none"> The USB memory device format should be set to FAT16 or FAT32. For details, refer to the USB memory device's operating instructions. If the USB memory device is divided into multiple partitions, only files in partition one can be played. Files are stored in a non-compatible format. Record the files in a compatible format. You are attempting to play a file that is copyright protected. Files that are copyright protected cannot be played on this unit. 	– – 42 42
Internet radio cannot be played.	<ul style="list-style-type: none"> Ethernet cable is not properly connected or network is disconnected. Check the connection status. Program is being broadcast in non-compatible format. Only Internet radio programs in MP3 and WMA can be played on this unit. The firewall of the PC or router has been activated. Check the firewall settings of the connected PC or router. Radio station is not currently broadcasting. Choose a radio station that is currently broadcasting. IP address is wrong. Check the set's IP address. Some radio stations may go silent at certain times of the day. In this case, no audio is output even when a station is received. Try again later, or switch to another radio station. 	27 54 – 54 136 –

Symptom	Cause/Solution	Page
Files stored on a computer cannot be played.	• Files are stored in a non-compatible format. Record in a compatible format.	57
	• You are attempting to play a file that is copyright protected. Files that are copyright protected cannot be played on this unit.	57
	• Set and computer are connected by USB cable. The set's iPod/USB port cannot be used for connection to a computer.	–
	• Media sharing settings are not correct. Change media sharing settings so that the unit can access the folders on your computer.	58
Music stored on a NAS cannot be played.	• If you use a NAS in conformity with the DLNA standard, enable the DLNA server function in the NAS setting.	–
	• If you use a NAS that does not conform with the DLNA standard, play the music via a PC. Set Windows Media Player's media sharing function and add NAS to the selected play folder.	58
	• If connection is restricted, set audio equipment as the connection target.	–
Server is not found, or it is not possible to connect to the server.	• The computer's or router's firewall is activated. Check the computer's or router's firewall settings.	–
	• Computer's power is not turned on. Turn on the power.	–
	• Server is not running. Launch the server.	–
	• Set's IP address is wrong. Check the set's IP address.	136
Cannot connect to preset or favorite radio stations.	• Radio station is not currently broadcasting. Wait a while before trying again.	–
	• Radio station is not currently in service. It is not possible to connect to radio stations that are no longer in service.	–
A list of broadcasting stations is not displayed.	• Connection to the network is unstable. Reconnect to the network or redo the "Network" setting in the menu.	27 , 137
For some radio stations, "Radio station server full" or "Connection down" is displayed and station cannot be connected to.	• Station is congested or not currently broadcasting. Wait a while before trying again.	–
Sound is broken during playback.	• Network or USB memory device's signal transfer speed is slow or communications lines or radio station is congested. This is not a malfunction. When playing broadcast data with a high bit rate, the sound may be broken, depending on the communications conditions.	–

Symptom	Cause/Solution	Page
Sound quality is poor or noise is heard during play.	• File being played has a low bit rate. This is not a malfunction.	–
Cannot login to Pandora. ("Email address" or "Password" is displayed.)	• Login information is incorrect. Check if the "Email address" for Pandora has been properly entered. Re-enter the "Password". (Password is not displayed.) http://www.pandora.com/marantz	64

[AirPlay]

Symptom	Cause/Solution	Page
The AirPlay icon  is not displayed in iTunes or on the iPhone/iPod touch/iPad.	• This unit and the computer or iPhone/iPod touch/iPad are not connected to the same network (LAN). Connect the computer or iPhone/iPod touch/iPad to the same network as this unit. • iTunes or the iPhone/iPod touch/iPad do not have firmware that supports AirPlay installed. Update to the latest firmware.	27 143
No sound.	• The volume in iTunes or on the iPhone/iPod touch/iPad is set to the minimum setting. Adjust the volume to the optimum level. • This unit is not selected in the screen that is displayed when iTunes or the iPhone/iPod touch/iPad is started. Start iTunes or switch on the iPhone/iPod touch/iPad, click the AirPlay icon  in the displayed screen, and select this unit. • AirPlay playback has not started. Click the  button in iTunes or press the  button on the iPhone/iPod touch/iPad.	– 73 –
When using AirPlay with the iPhone/iPod touch/iPad, the sound suffers from intermittent breaks or AirPlay does not function.	• Quit the application running in the background of the iPhone/iPod touch/iPad, and then play using AirPlay. • When playing via a wireless connection, outside conditions may affect the unit. To remedy this, change the network environment, e.g. shorten the distance to the wireless LAN access point. • Update the iPhone/iPod touch/iPad application or iTunes to the latest version.	– – –

[M-XPort]

Symptom	Cause/Solution	Page
Audio is not output when a wireless receiver (RX101 is connected).	<ul style="list-style-type: none">• Check that the Bluetooth device and Wireless receiver (RX101) are correctly paired.	24 , 171 , 173

[Remote control unit]

Symptom	Cause/Solution	Page
The set cannot be operated with the remote control unit.	<ul style="list-style-type: none">• Batteries are worn out. Replace with new batteries. 161• Operate the remote control unit within a distance of about 23 ft/7 m from this unit and at an angle of within 30°. 161• Remove any obstacle between this unit and the remote control unit. 161• Insert the batteries in the proper direction, checking the ⊕ and ⊖ marks. 161• The set's remote control sensor is exposed to strong light (direct sunlight, inverter type fluorescent bulb light, etc.). Move the set to a place in which the remote control sensor will not be exposed to strong light. 161• The setting of the zone to operate does not match. Press ZONE SELECT to select the zone to operate. 30, 106	

Resetting the microprocessor

Perform this procedure if the display is abnormal or if operations cannot be performed. When the microprocessor is reset, all the settings are reset to their default values.

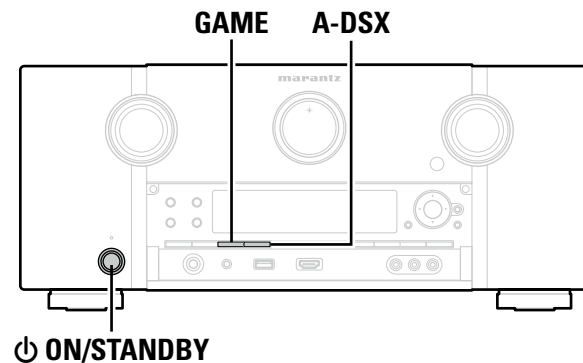

- 1** Turn off the power using **⏻**.
- 2** Press **⏻ ON/STANDBY** while simultaneously pressing **GAME** and **A-DSX**.
- 3** Once the display starts flashing at intervals of about 1 second, release the two buttons.



If in step 3 the display does not flash at intervals of about 1 second, start over from step 1.

Specifications

□ Audio section

• Power amplifier

Rated output:
 Front:
 125 W + 125 W (8 Ω, 20 Hz – 20 kHz with 0.08 % T.H.D.)
 Center:
 125 W (8 Ω, 20 Hz – 20 kHz with 0.08 % T.H.D.)
 Surround:
 125 W + 125 W (8 Ω, 20 Hz – 20 kHz with 0.08 % T.H.D.)
 Surround back / Front height / Front wide:
 125 W + 125 W (8 Ω, 20 Hz – 20 kHz with 0.08 % T.H.D.)

Maximum effective output power:

Front:
 195 W + 195 W (6 Ω, 1 kHz with 10 % T.H.D.)
 Center:
 195 W (6 Ω, 1 kHz with 10 % T.H.D.)
 Surround:
 195 W + 195 W (6 Ω, 1 kHz with 10 % T.H.D.)
 Surround back / Front height / Front wide:
 195 W + 195 W (6 Ω, 1 kHz with 10 % T.H.D.)

Output connectors:

6 – 8 Ω

• Analog

Input sensitivity/Input impedance: 200 mV/47 kΩ
Frequency response: 10 Hz – 100 kHz — +1, –3 dB (DIRECT mode)
S/N: 96 dB (IHF–A weighted, DIRECT mode)
Distortion: 0.008 % (20 Hz – 20 kHz) (DIRECT mode)
Rated output: 1.2 V

• Digital

D/A output:
 Rated output — 2 V (at 0 dB playback)
 Total harmonic distortion — 0.008 % (1 kHz, at 0 dB)
 S/N ratio — 102 dB
 Dynamic range — 100 dB
 Format — Digital audio interface

Digital input:

• Phono equalizer (PHONO input – MEDIA PLAYER OUT)

Input sensitivity: 2.5 mV
RIAA deviation: ±1 dB (20 Hz to 20 kHz)
S/N: 74 dB (A weighting, with 5 mV input)
Rated output: 150 mV
Distortion factor: 0.03 % (1 kHz, 3 V)

□ Video section

• Standard video connectors

Input/output level and impedance: 1 V_{p-p}, 75 Ω
Frequency response: 5 Hz – 10 MHz — +1, –3 dB

• Color component video connector

Input/output level and impedance: Y (brightness) signal — 1 V_{p-p}, 75 Ω
 P_B / C_B signal — 0.7 V_{p-p}, 75 Ω
 P_R / C_R signal — 0.7 V_{p-p}, 75 Ω
Frequency response: 5 Hz – 60 MHz — 0, –3 dB

□ Tuner section

(ANTENNA input – MEDIA PLAYER OUT)

	[FM]	[AM]
Receiving Range:	(Note: μV at 75 Ω, 0 dBf = 1 x 10 ⁻¹⁵ W) 87.5 MHz – 107.9 MHz	530 kHz – 1710 kHz
Usable Sensitivity:	1.5 μV (14.8 dBf)	20 μV
S/N (IHF–A weighted):	MONO 78 dB	
	STEREO 68 dB	
	HD 85 dB	85 dB
Distortion (1 kHz):	MONO 0.1 %	
	STEREO 0.2 %	
	HD 0.02 %	0.02 %

□ General

Power supply: AC 120 V, 60 Hz
Power consumption: 670 W
Power consumption in standby mode: 0.2 W
Power consumption in CEC standby mode: 0.5 W
Power consumption in network standby mode: 2.7 W

For purposes of improvement, specifications and design are subject to change without notice.

Index

Numerics

2.1-channel	89
3D	12
5.1-channel	83, 87
6.1-channel	83, 86
7.1-channel	83, 85

A

A2DP	24, 171
Accessories	2
Add New Feature	144
Adjust EQ	118
Adjusting the master volume	37
Adobe RGB color / Adobe YCC601 color	171
AirPlay	73, 171
AM loop antenna	23
Amp Assign	131
App Store	171
ARC	9
Aspect Ratio	123
Audio	112, 124
Audio Delay	116
Audio Display	124
Audyssey	116
Audyssey DSX®	82, 117
Audyssey Dynamic EQ®	117, 171
Audyssey Dynamic Surround Expansion	171
Audyssey Dynamic Volume®	117, 171
Audyssey MultEQ® XT	116, 171
Audyssey® Setup	29, 91
Auto Lip Sync	120, 171
Auto Preset Memory	49
Auto Standby	141

B

Bass	114, 132, 140
Bi-amp	90
Bluetooth	24, 171
Brightness	120

C

Cable	
Audio cable	13
Coaxial digital cable	13
Component video cable	13
Ethernet cable	13
HDMI cable	10, 11
Optical cable	13
Speaker cable	85, 86, 87, 88, 89, 90
Subwoofer cable	85, 86, 87, 88, 89, 90
Video cable	13
Center Image	113
Center Width	114
Channel	140, 141
Characters	111
Component	123
Component Video Out	123
Condensation	3
Connection	
7.1CH IN	25
Blu-ray Disc player	11, 17
Cable TV	15
CD player	21
DC OUT	95
Digital camcorder	11, 18
DVD player	11, 16
External power amplifier	26
Game console	11
HDMI	8
HD Radio reception	23
Home network (LAN)	27
iPod (USB)	20
Media player	11, 19
Power cord	28
Record player	22
Remote control jacks	94
RS-232C	95
Satellite tuner	15
Set-top box	11, 15
Speaker	84
TV	10, 14
USB memory device	20
Wireless receiver	24
Content Type	12
Contrast	120
Control Monitor	121
Crossovers	134
Curve Copy	118

D

Decode Mode	128
Deep Color	12, 171
Dialogue	114
Dialogue Level	114
Dimension	113
Direct Mode	39, 40
Direct Tune	48
Display	141, 157
Distances	133
DLNA	171
Dolby	
Dolby Digital	79, 171
Dolby Digital EX	79, 171
Dolby Digital Plus	79, 171
Dolby Pro Logic	79
Dolby Pro Logic II	79, 171
Dolby Pro Logic IIx	79, 171
Dolby Pro Logic IIz	79, 82, 171
Dolby TrueHD	79, 171
Downmix	172
DTS	172
DTS 96/24	79, 172
DTS Digital Surround	172
DTS-ES Discrete 6.1	79, 172
DTS-ES Matrix 6.1	79, 172
DTS Express	79, 172
DTS-HD	79, 172
DTS-HD High Resolution Audio	172
DTS-HD Master Audio	172
DTS NEO:6™ Surround	79, 172
Dual backup memory function	101
Dynamic Compression	113
Dynamic EQ	117
Dynamic range	172
Dynamic Volume	117

E

Edit Name	136
Enhancer	120
Error messages (Audyssey® Setup)	34

F

Favorite Memory	71
Firmware	143
FLAC	172
Flickr	61, 62
FM	46

FM indoor antenna	23
Format	124
Friendly Name	136
Front A/B (connection)	83, 88
Front Display	141
Front Height	132
Front height speaker	83, 85
Front Panel	155
Front Speaker	134
Front Wide	132
Front wide speaker	83, 85

G

General	139
Graphic EQ	118

H

HDCP	12, 172
HDMI	8, 12, 172
HDMI Audio Out	120
HDMI Control	96, 121
HDMI Setup	120
Headphones	156
Height Gain	114
Hide Sources	128
High Pass Filter	140
Home Theater EQ	113
Hue	120

I

Info Display	123
Information	136, 142
Audio	142
Firmware	142
Video	142
ZONE	142
Input Assign	126
Input Mode	128
Inputs	125
Input Select	128
Input signal	166
Inputting characters	111
IP Control	136
i/p Scaler	122
iTunes	172

L	
Language	140
Lch Level	140
Levels	133
LFE	172
Limit	116
Listening mode	75
Listening position	29
Lock	144
Loudness Management	113
Low Frequency Effects	113
M	
Maintenance Mode	138
MAIN ZONE	172
Manual Setup	131
M-DAX	115
Menu map	107
Mode	115
MP3	172
MPEG	172
MultEQ® XT	116
Mute Level	116, 140
N	
Network	35, 135
Noise Reduction	120
Notifications	143
O	
On-screen Info	123
Operation Mode	40
Output Settings	122
P	
Pairing	173
Pandora®	61, 64
Panel lock function	101
Panorama	113
Parameter Check	35
Picture Adjust	120
Picture View	72
Playback	
Auto surround	76
Blu-ray Disc player	37
CD player	38
Direct	75, 80
DVD player	37
FLAC	42, 57

Flickr	62
FM	46
Internet radio	54
iPod (USB)	39
JPEG	42, 57
MP3	42, 54, 57
MPEG-4 AAC	42, 57
NAS	57
Original listening mode	80
Pandora®	64
PC	57
Pure direct	75, 80
SiriusXM	67
Stereo	80
Super Audio CD	37
USB memory device	42
WAV	42, 57
WMA	42, 54, 57
ZONE2	106
ZONE3	106
Power Off Control	121
Power On Level	116
Power On Volume	140
Preset codes	145, 183
Preset Memory	50
Preset Name	51
Preset Skip	52
Progressive	173
Progressive Mode	123
Protection circuit	173

R	
Random	41, 70
Rch Level	140
Rear panel	159
Reference Level Offset	117
Remote control setting	30, 91
Remote control unit	160
Inserting the batteries	161
Operating external devices	148
Operating learn function	151
Registering preset codes	145
Setting the back light	153
Remote lock function	102
Remote Mode	39, 40
Remove Favorites	72
Repeat	41, 70
Resetting the microprocessor	179
Resolutions	122

S	
Sampling frequency	173
Saturation	120
Scale	116
Selecting the input source	36
Settings	137
Setup Lock	144
SiriusXM	61, 67
Sleep timer	98, 106
Slideshow	72
Sound Mode	75, 163
Source Level	128
Source Rename	127
Speaker	
Connect	84
Install	82
Set up	29, 91
Speaker Config.	131
Speaker impedance	84, 173
Speakers	130
Speaker Select	114
Speaker Selection	118
Stage Height	118
Stage Width	118
Standby Source	121
Subwoofer	115
Subwoofer Level	115
Subwoofer setting	30
Surr. Back	132
Surround back speaker	83, 85, 86
Surround Parameter	113
sYCC601 color	173
T	
Text Search	69
Tone	114
Tone Control	114
Trademark	162
Treble	114, 140
Trigger Out 1	141
Trigger Out 2	141
Troubleshooting	174
Tune Mode	47
Turning off the sound temporarily	37
Turning the power on	36
TV Format	124
U	
Update	143

V	
Video	119
Video conversion	6
Video Conversion	122
Video Mode	122
Video Output	121
Video Source	129
Volume	116, 123
Volume Display	123
Volume Level	140
Volume Limit	140
vTuner	56, 173

W	
Web control	99
Windows Media DRM	173
Windows Media Player	173
WMA	173

X	
x.v.Color	173

Z	
ZONE2	104, 158, 173
ZONE2 Setup	140
ZONE3	104, 158, 173
ZONE3 Setup	140
Zone Rename	141

List of preset codes

AVR

M Marantz 0000

TV group (1***)

A Acer	1141
Acer	1141
Admiral	1009, 1089, 1002
Aiko	1059
Aiwa	1117, 1118
Aiwa	1117
Aiwa	1118
Akai	1001
Amtron	1023
Anam	1113
Anam National	1023, 1069, 1092
AOC	1003, 1049, 1024, 1127
Audiovox	1023
B Bell & Howell	1009, 1025
Benq	1142
Benq	1104, 1142
Broksonic	1097, 1098, 1113, 1003
Broksonic	1098
Broksonic	1097
C Celebrity	1001
Citizen	1003, 1023, 1059, 1063, 1026, 1013
Colortyme	1003, 1043
Contec/Cony	1045, 1047, 1023, 1113
Craig	1023, 1113, 1020, 1022
Crown	1023, 1067
Curtis Mathes	1003, 1110, 1025, 1062, 1026, 1103, 1013
D Daewoo	1003, 1059, 1024, 1084, 1101, 1013, 1035, 1036
Daewoo	1101
Daytron	1003, 1013, 1016
Dimensia	1110, 1103
Dumont	1010, 1003, 1153
E Electroband	1001
Electrohome	1003, 1133, 1001, 1069
	1003, 1020, 1044, 1038, 1045, 1048, 1055, 1023, 1025, 1061, 1022, 1094, 1096, 1099, 1013, 1113, 1101, 1015, 1021
Emerson	
Envision	1003
F Fisher	1051, 1025, 1091, 1160
Fujitsu	1124, 1125
Fujitsu	1038, 1155
Funai	1038, 1023, 1113
G Gateway	1150

GE	1110, 1003, 1085, 1046, 1054, 1133, 1018, 1069, 1022, 1103, 1113, 1136, 1153
Goldstar	1045, 1024, 1112, 1080, 1100, 1013, 1003, 1030, 1154
H Hallmark	1003
Hisense	1116
Hitachi	1041, 1003, 1045, 1047, 1032, 1065, 1068, 1088, 1082, 1037, 1094, 1031, 1159
Hitachi	1145, 1139, 1012
Hitachi	1139, 1140
I Infinity	1067
J Janeil	1134
JBL	1067
JC Penney	1003, 1046, 1047, 1054, 1133, 1110, 1019, 1112, 1024, 1063, 1018, 1026, 1083, 1085, 1100, 1103, 1013, 1154
Jensen	1003
JVC	1045, 1047, 1050, 1060, 1065, 1028, 1029
JVC	1028
JVC	1028
K Kawasho	1003, 1001
Kenwood	1003
Kloss Novabeam	1056, 1023, 1057, 1134
KTV	1023, 1073, 1099, 1013, 1113, 1033, 1034
L LG	1024, 1030
M M.Wards	1002, 1009, 1038
Maganvox	1067
Magnavox	1003, 1052, 1053, 1056, 1057, 1063, 1081, 1067, 1106
Marantz	1000, 1003, 1122, 1067, 1031
Mitsubishi	1024
Mitsubishi	1003, 1051, 1133, 1122, 1024, 1115
Motorola	1069, 1014
N NEC	1003, 1043, 1024, 1069, 1012
NET-TV	1137
NET-TV	1150
O Orion	1020, 1096
P Panasonic	1111
Panasonic	1111
Panasonic	1111
Panasonic	1111
Panasonic	1111, 1017
Panasonic	1067, 1069, 1111
Panasonic	1111

Panasonic	1111
Panasonic	1111
Panasonic	1111
Panasonic	1111
Panasonic	1111
Panasonic	1095, 1111
Philips	1003, 1045, 1052, 1054, 1056, 1057, 1058, 1063, 1069, 1067, 1011
Philips Magnavox	1106, 1067
Philips Magnavox	1106
Pioneer	1003, 1018, 1070, 1071, 1037, 1094
Pioneer	1145
Pioneer	1147
Pioneer	1149
Plasmsync	1135
Portland	1003, 1059, 1024, 1013
Price Club	1026
Prism	1018
Proscan	1110, 1085, 1103, 1004, 1005, 1006, 1007, 1008
Proscan	1110
Proton	1003, 1045
Q Quasar	1069, 1073, 1111, 1010, 1153
R Radio Shack	1025, 1103, 1113, 1024
Radio Shack/Realistic	1003, 1045, 1023, 1110, 1025, 1015, 1100, 1013
	1110, 1003, 1049, 1024, 1069, 1075, 1079, 1085, 1087, 1088, 1093, 1094, 1101, 1103, 1085, 1113, 1004, 1005, 1006, 1007, 1008
RCA	
RCA	1110
RCA	1153
RCA	1110
RCA	1014
Realistic	1025, 1103
Runco	1010, 1153
S Sampo	1150
Sampo	1150
Samsung	1003, 1045, 1024, 1062, 1026, 1078, 1083, 1090, 1100, 1013, 1105, 1040
Samsung	1105, 1114, 1157, 1090
Samsung	1120, 1121, 1105
Samsung	1148
Samsung	1146
Sansui	1119
Sanyo	1003, 1051, 1025, 1072, 1077, 1091, 1156, 1157, 1158

Sharp	1003, 1045, 1055, 1015, 1064, 1066, 1076, 1089, 1013, 1014
Sharp	1014
Sharp	1123, 1014
Signature	1009
Sony	1001, 1102
Sony	1001
Sony	1001
Sony	1001
Sony	1108
Soundesign	1003, 1038, 1023, 1063, 1113
Starlite	1023
Supre-Macy	1134
Sylvania	1151
Sylvania	1003, 1042, 1052, 1053, 1063, 1056, 1057, 1067, 1089, 1151, 1039
Sylvania	1089
Symphonic	1044, 1023, 1039
T Tandy	1014
Tatung	1069
Technics	1018
Techwood	1003, 1018
Teknika	1003, 1009, 1038, 1045, 1047, 1063, 1023, 1059, 1024, 1063, 1026, 1111, 1013, 1113
Telecaption	1074
Toshiba	1042, 1025, 1074, 1026, 1098, 1003, 1107, 1019
Toshiba	1136
Toshiba	1111, 1135
Toshiba	1135
Toshiba	1019
Toshiba	1098
Toshiba	1107
Totevision	1013
U Universal	1046, 1054
V Video Concepts	1113
Viewsonic	1130, 1128, 1006, 1131, 1129, 1109, 1143, 1150, 1022
Viewsonic	1150, 1145
Viewsonic	1138
W Wards	1003, 1009, 1044, 1038, 1046, 1052, 1054, 1056, 1110, 1057, 1024, 1015, 1067, 1086, 1103
White Westinghouse	1101, 1001
Y Yamaha	1003, 1024
Z Zenith	1010, 1153
Zenith	1132
Zenith	1010, 1153

Zenith	1010, 1153
Zenith	1010, 1153
Zenith	1010, 1003, 1009, 1144, 1153

DVD group (2***)

A Aiwa	2036
Aiwa	2037
Apex	2017, 2034, 2018, 2019, 2021, 2012
B Bluray	2064
BOSE	2038, 2039, 2063
D Denon	2047, 2048
F Funai	2049
G GE	2020, 2029, 2033, 2009
H Harman Kardon	2061
Hitachi	2031, 2012, 2008
Hitachi	2031
J JVC	2006, 2010, 2040, 2041, 2042, 2043
JVC	2042
JVC	2043
K Kenwood	2054, 2053
Koss	2058
M Magnavox	2023, 2025, 2011, 2007
Marantz	2000, 2025, 2065
Mitsubishi	2011, 2015
O Onkyo	2062
Onkyo	2062
Oritron	2030, 2009
P Panasonic	2003, 2015, 2016
Panasonic	2055
Philips	2007, 2011
Philips	2058
Pioneer	2002, 2014
Pioneer	2056
Proscan	2020, 2032, 2009
R RCA	2020, 2005, 2009, 2035
RCA	2057
S Sampo	2041
Samsung	2008, 2022, 2024, 2027, 2012
Samsung	2022
Samsung	2027
Sanyo	2050, 2052
Sanyo	2052
Sharp	2044, 2045
Sherwood	2051
Sony	2001, 2013
Sony	2059

T	Toshiba	2004, 2026, 2028, 2008
	Toshiba	2028
	Toshiba	2026
Y	Yamaha	2046
	Yamaha	2060
Z	Zenith	2010
	Zenith	2010

CD group (3***)

A	AIWA	3001, 3002, 3003
	AKAI	3004, 3005, 3006
	AUDIO	3007
	AUDIO LABS	3008
C	CALIFORNIA	3008
	CARVER	3010, 3011, 3009
	CASIO	3012, 3020
	CURTIS	3020, 3012
D	DENON	3013
E	EMERSON	3014
F	FISHER	3011, 3015, 3016, 3017, 3018
G	GE	3019
	GENEXXA	3014, 3021, 3020
H	HARMON	3022, 3023, 3051
	HITACHI	3020
I	INKEL	3024
J	JC PENNEY	3012, 3020, 3025
	JVC	3026, 3027
K	KARDON	3022, 3051, 3023
	KENWOOD	3028, 3029, 3030, 3031, 3032, 3033
	KRELL	3010
L	LUXMAN	3035, 3036, 3037, 3038
	LX I	3012, 3020, 3014
M	MAGNAVOX	3010, 3039, 3040
	MARANTZ	3000, 3010, 3041, 3042, 3043
	MATHES	3012, 3020
	MCS	3012, 3020
	MGA	3023
	MISSION	3010
	MITSUBISHI	3023, 3044
N	NAD	3034, 3045
	NAKAMICHI	3046, 3047, 3048
	NEC MCS	3025
	NIKKO	3007, 3016
O	ONKYO	3049, 3050, 3051, 3052, 3055, 3102, 3103
	OPTIMUS	3011, 3014, 3020, 3028, 3053, 3054, 3056, 3057, 3058, 3059
P	PANASONIC	3008, 3060, 3061
	PHILIPS	3009, 3010, 3010, 3040

	PIONEER	3020, 3021, 3062, 3063, 3064
Q	QUASAR	3008
R	RCA	3011, 3014, 3065, 3066, 3067, 3068, 3069
	REALISTIC	3011, 3014, 3020, 3042, 3054, 3057
	ROTEL	3010
	RS ORIGINAL	3070
S	SAE	3010, 3083
	SAMSUNG	3071
	SANSUI	3014, 3068, 3072, 3073
	SANYO	3011, 3018, 3074, 3075, 3076
	SCOTT	3014
	SEARS	3012, 3014, 3020, 3028, 3042
	SHARP	3028, 3042, 3077
	SHERWOOD	3042, 3056, 3070, 3078, 3024
	SHURE	3025
	SONY	3039, 3079, 3080, 3081, 3082, 3097, 3098, 3099, 3100, 3101
	SYLVANIA	3010
	SYMPHONIC	3083
T	TEAC	3016, 3042, 3057, 3083, 3084, 3085, 3086
	TECHNICA	3007, 3008, 3061, 3087, 3088
	THETA DIGITAL	3040
	TOSHIBA	3045
V	VICTOR	3026
Y	YAMAHA	3007, 3089, 3090, 3091, 3092
Z	ZENITH	3016, 3093, 3094, 3095, 3096

CBL/SAT group (4***)

A	Alphastar	4027
	Amstrad	4046, 4047, 4050
	Apple TV	4068
	Atsky	4048
B	BSkyB	4021, 4045, 4046
C	Chaparral	4039
D	Direct Tv	4001, 4016, 4044
	DISH Network	4030
	Drake	4026
E	Echostar	4007, 4017, 4018, 4019, 4020, 4062, 4063, 4064
	Eurosky	4056, 4047
	Express Vu	4017
F	Foxtel	4051
	Freesat	4056
	Fujitsu	4025
G	GE	4002, 4008, 4009
	General Instruments	4036, 4037

	Gradiente	4044, 4057
H	Hitachi	4001, 4015
	Hughes Network	4001, 4016
	Humax	4049, 4050, 4051, 4052, 4053
J	Janeil	4025
	JVC	4017
L	LG Smart TV	4069
M	Marantz	4000
	Mitsubishi	4001
N	NETGEAR Neo TV	4072
	Nokia	4058, 4059, 4060, 4061
O	Optima	4048
P	Panasonic	4004, 4010
	Philips	4031, 4044, 4057
	Philips	4035
	Proscan	4002, 4008, 4009, 4011
R	Radio Shack	4036, 4037
	RCA	4002, 4008, 4009
	RCA	4029
	Realistic	4040
	Roku XDS	4073
	Rural Cable	4036
S	Samsung	4022, 4027, 4042, 4043, 4054, 4055, 4050
	Schneider	4041, 4043
	SKY	4044, 4045, 4057
	Skyplus	4048
	Skysat	4041, 4047, 4056
	Sony	4003, 4012, 4014, 4065, 4066, 4067
	Sony	4014, 4070
	Star Choice	4032
	Star Trak	4024
	STS	4038
	SuperDish	4028
T	Teac	4049
	Thomson	4046, 4056
	Toshiba	4001, 4034
U	Universum	4056
	Uniden	4005, 4006, 4013
V	Video Pall	4025
W	Western Digital WD TV	4071
Z	Zenith	4033, 4025
	Zenith	4023

BD group (5***)

D	Denon	5034, 5035, 5036
H	Hitachi	5031, 5032, 5033
I	Integra	5013
J	JVC	5014, 5015, 5017, 5018, 5019, 5020

L	LG	5010, 5011
M	Marantz	5000, 5026, 5027
	Mitsubishi	5024, 5025
O	Onkyo	5013
P	Panasonic	5001, 5002, 5003
	Philips	5004
	Pioneer	5005
R	RCA	5012
S	Samsung	5005
	Sharp	5028, 5029, 5030
	Sony	5007, 5008, 5009, 5016
T	Toshiba	5012
Y	Yamaha	5021, 5022, 5023

Dimensions

Unit : in. (mm)

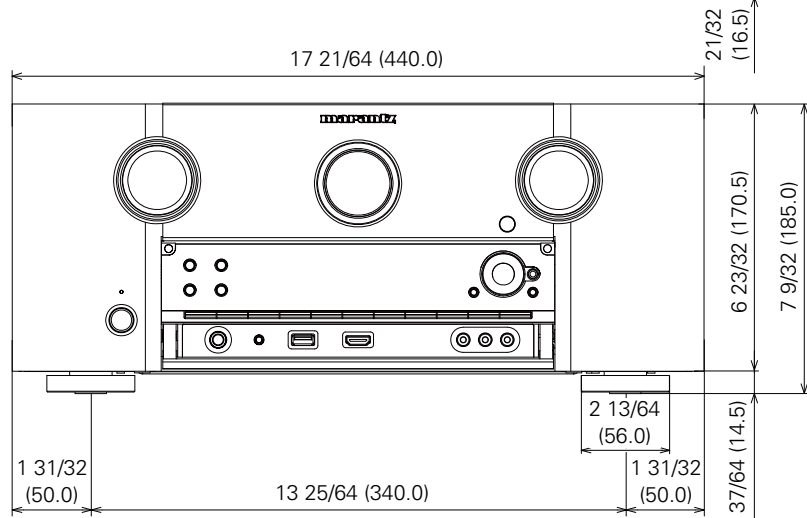
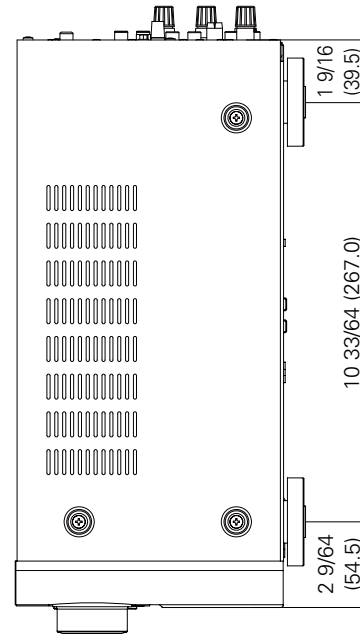
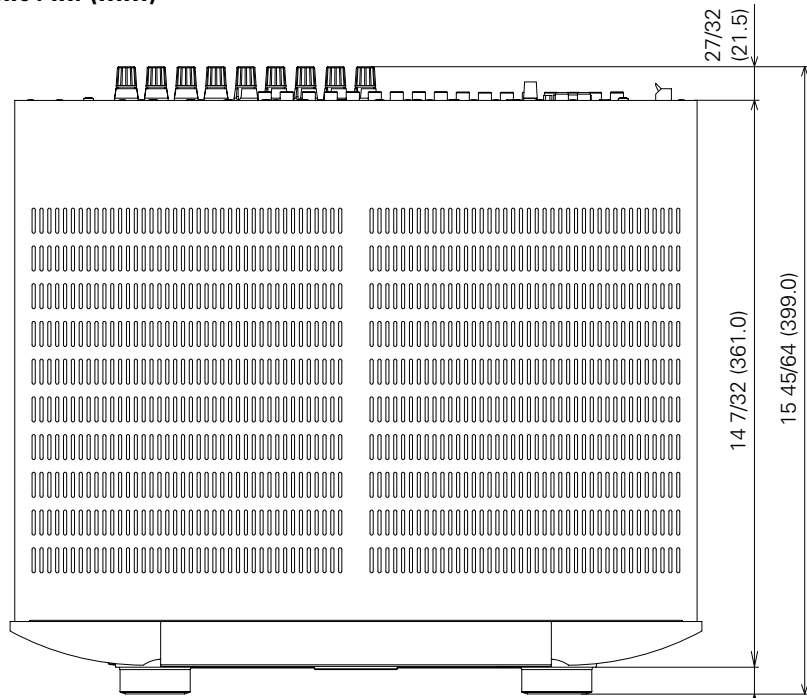

Weight : 27 lbs 9 oz (12.5 kg)

www.marantz.com

You can find your nearest authorized distributor or dealer on our website.

marantz[®] is a registered trademark.